

# Section - 01

  
*Splenor Surgicals*



**Pages 01 - 22**

- ★ Diagnostic
- ★ Anaesthesia
- ★ Scalpels
- ★ Knives



# Percussion Hammers & Aesthesiometers

*Splenor Surgicals*



**01-2001**  
TROEMNER  
Size: 245 mm

1/2



**01-2002**  
DEJERINE  
Size: 200 mm

1/2



**01-2003**  
DEJERINE  
With Needle  
Size: 210 mm

1/2



**01-2004**  
TAYLOR  
Size: 195 mm

1/2



**01-2005**  
BERLINER  
Size: 200 mm

1/2



**01-2006**  
BUCK  
With Needle  
And Brush  
Size: 180 mm

1/2



**01-2007**  
RABINER  
With Needle  
And Brush  
Size: 255 mm

1/2



**01-2008**  
ALY  
Size: 190 mm

1/2



**01-2009**  
WARTENBERG  
Pinwheel For  
Neurological  
Examination  
Size: 185 mm

1/2



# Stethoscopes

*Splenor Surgicals*



**01-2010**  
PINARD  
of aluminium  
Size: 155 mm

1/2



**01-2011**  
aus Holz  
Wooden  
Size: 145 mm

1/2



**01-2012**  
BOWLES  
Stethoscope With  
Diaphragm,  
In Plastic Pouch

1/4



**01-2013**  
ANESTOPHON  
Ø47mm

1/2



**01-2014**  
FORD-BOWLES  
Combination Stethoscope  
With Diaphragm and Bell  
Dual Chest Piece  
With Two Outlets



1/4



**01-2015**  
BOWLES  
Stethoscope With  
Diaphragm,  
Flat Model,  
Suitable Also  
For Anaesthesia  
Chest Piece Only  
40 mm Diam

1/4



## Head Mirrors & Head Bands

*Splenor Surgicals*



**01-2016**  
ZIEGLER Ø 90mm  
Head mirror only  
with rubber coating



**01-2017**  
ZIEGLER Ø 90mm  
Head mirror only  
with metal coating



**01-2018**  
ZIEGLER  
Head band of plastic, black only

**01-2019**  
ZIEGLER  
Head band of plastic, white only



**01-2020**  
MURPHY  
Head band of celluloid, white only



**01-2021**  
Head band of plastic,  
white, soft pattern



**01-2022**  
Head mirror  
with black plastic head  
band



# Head Lights

# Splenor Surgicals



**01-2023**  
CLAR  
Head light, 6 volt, with adjustable joint, white celluloid head band, cord with plugs for transformer

**01-2024**  
White celluloid head band, only, for **01-2023**

**01-2025**  
Spare mirror only, for **01-2023**



**01-2027**  
CLAR  
Head light, 6 volt, with adjustable joint, white celluloid head band, with foam rubber pad and cord with plugs for transformer

**01-2028**  
White celluloid head band, only, for head light

**01-2029**  
mirror only, for head light

**01-2030**  
spare foam rubber pad, for head band



**01-2032**  
JANSEN  
Head light, 6 volt, with adjustable joint, white plastic head band, cord with plugs for transformer



**01-2034**  
LANGENBECK  
Head light, 3.7 volt, with adjustable joint, white plastic head band, cord with plugs for transformer



**01-2036**  
HERBERHOLD  
Pocket-Accu, 6 volts, with cord for head lights



**01-2037**  
Extension cord only, to connect the accu to the cord of the head lights



**01-2038**  
Charging Set for pocket accu **01-2036**  
mains current: 220-240 volts, 50-60 Hz



**01-2039**  
220 volt / 220 volts  
**01-2040**  
120 volt / 120 volts  
Transformer



# Tongue Depressors, Retractors

*Splenor Surgicals*

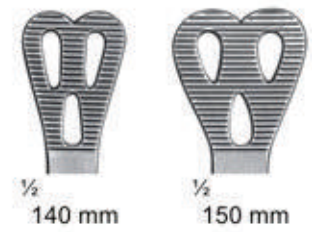
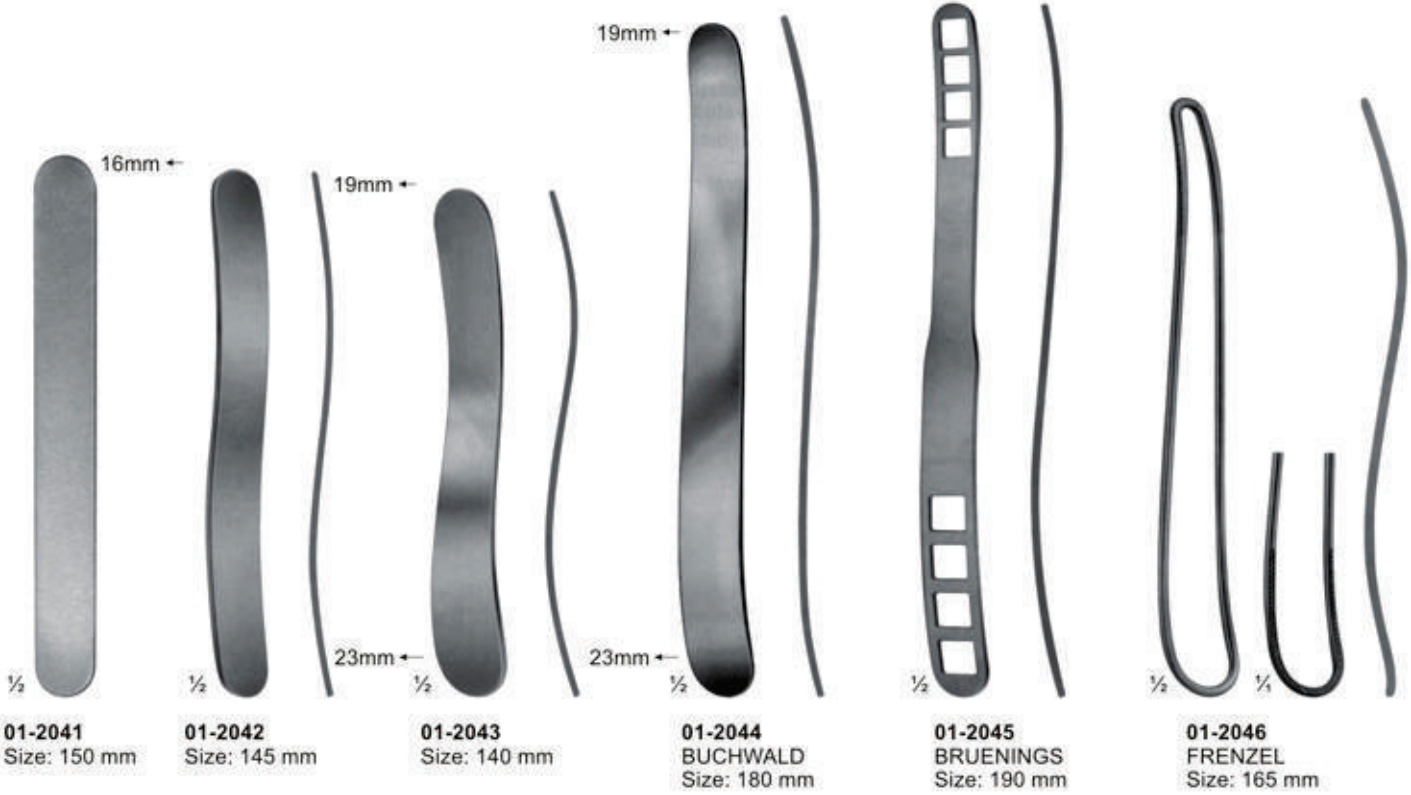



# Mouth Gags And Tongue Forceps

*Splenor Surgicals*



½  
**01-2055**  
SCHIMMELBUSCH  
Ether Mask



½  
**01-2056**  
HEISTER  
Mouth Gag  
Size: 130 mm



½  
**01-2057**  
FERGUSSON-ACKLAND  
Mouth Gag  
Size: 145 mm



½  
**01-2058**  
DENHARDT  
Mouth Gag With  
Silicon Inserts,  
Interchangeable  
Size: 125 mm



½  
**01-2059-01-2060**  
ROSIER KOENIG  
Mouth Gag  
Size: **01-2059** 160mm  
**01-2060** 185mm

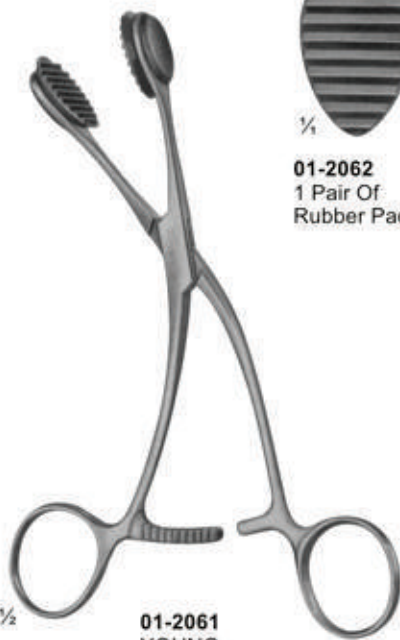

½  
**01-2061**  
YOUNG  
Size: 165 mm



½  
**01-2062**  
1 Pair Of  
Rubber Pads



½  
**01-2063-2064**  
COLLIN



¼  
**01-2063**  
Size: 160 mm



¼  
**01-2064**  
Size: 170 mm



½  
**01-2065**  
HEYWOOD-SMITH modif.  
Size: 215 mm



# Blood Lancets & Laryngeal Mirrors

*Splenor Surgicals*



**01-2066**  
MICHEL  
Rhinoscopic Mirrors  
With Interchangeable  
Mirror Inserts  
Size: 250 mm



**01-2067**  
Ø 12 mm  
Spare Mirrors Only



**01-2068**  
Ø 14 mm  
Spare Mirrors Only



**01-2069**  
Mirror Handle  
Size: 110 mm



**01-2070**  
Mirror Handle  
Size: 105 mm



**01-2071**  
FRANCKE  
Automatic  
Blood Lancet



**01-2072**  
KOLLE  
Microscopic  
Needle Holder  
With Plastic  
Handle  
Size: 240 mm



**01-2073**  
Laryngeal Mirrors With  
Hexagonal Handle  
Size: 180 mm



Fig. 000  
Ø 6mm



Fig. 00  
Ø 8mm



Fig. 0  
Ø 10mm



Fig. 1  
Ø 12mm

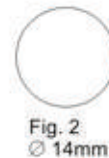

Fig. 2  
Ø 14mm

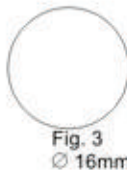

Fig. 3  
Ø 16mm

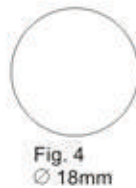

Fig. 4  
Ø 18mm

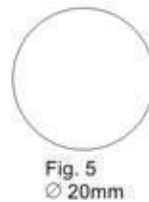

Fig. 5  
Ø 20mm

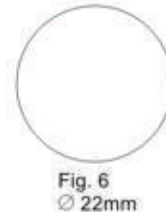

Fig. 6  
Ø 22mm

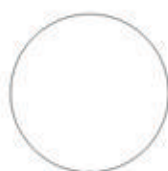

Fig. 7  
Ø 24mm

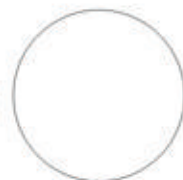

Fig. 8  
Ø 26mm

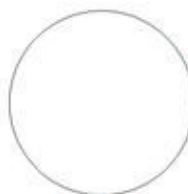

Fig. 9  
Ø 28mm

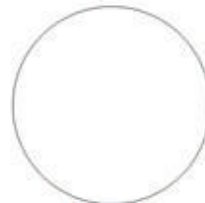

Fig. 10  
Ø 30mm





**Diagnostic Sets**



1/2

**01-2074 - 01-2076**  
MAGILL  
Catheter Introducing  
Forceps



1/4

**01-2074**  
Infants  
Size: 150 mm



1/4

**01-2075**  
Children  
Size: 200 mm



1/4

**01-2076**  
Adults  
Size: 250 mm



1/2

**01-2077**  
Medium battery handle  
only, 25 mm diam.



**01-2078**  
Spare bulb  
2.7 volt, for  
Otoscopies etc.



**01-2079**  
Spare bulb  
2.6 volt, for  
ophthalmoscopes



**01-2080**  
Otoscope Set, Consists Of  
Battery Handle Without Batteries,  
3 Ear Specula, 1 Bulb In Velvet Lined Case



**01-2081**  
Diagnostic Set, Otoscope With Three Specula,  
Nasal Speculum, Lamp Holder, Two Laryngeal  
Mirrors, Tongue Blade Holder



# Laryngoscopes

# Splenor Surgicals



1/2

**01-2082 MILLER**  
Laryngoscope Set, Consists Of Battery Handle ( Without Battery )  
With Five Miller Laryngoscope Blades, Fig 1 to 5

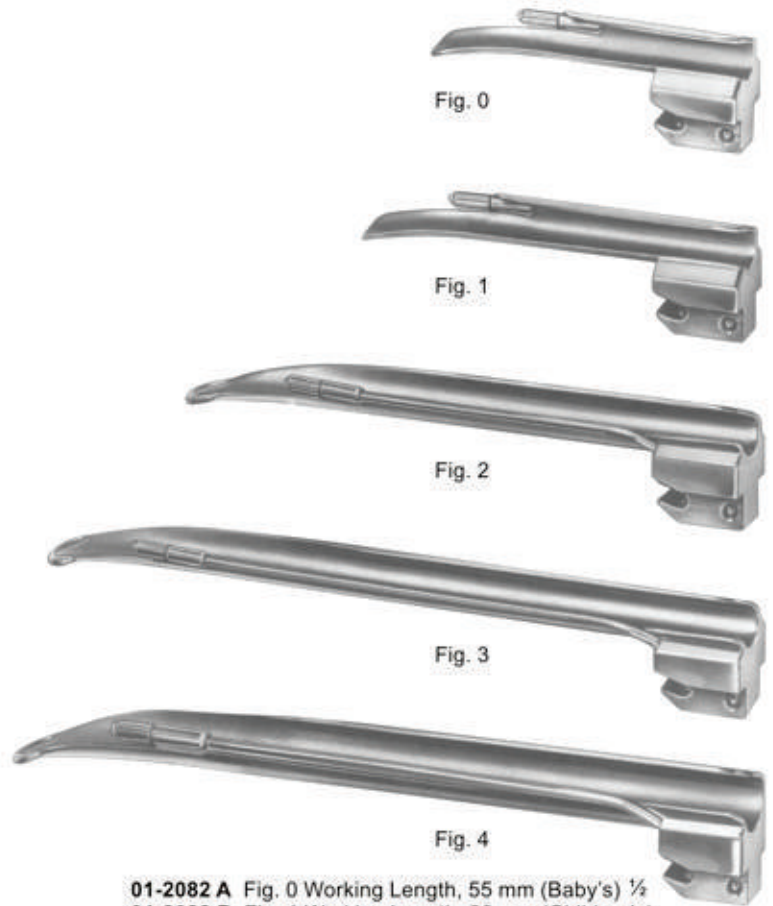

Fig. 0

Fig. 1

Fig. 2

Fig. 3

Fig. 4

- 01-2082 A** Fig. 0 Working Length, 55 mm (Baby's) 1/2
- 01-2082 B** Fig. 1 Working Length, 80 mm (Children's)
- 01-2082 C** Fig. 2 Working Length, 130 mm (Adolescent's)
- 01-2082 D** Fig. 3 Working Length, 170 mm (Women's)
- 01-2082 E** Fig. 4 Working Length, 180 mm (Men's)



1/2

**01-2083 GUEDEL-NEGUS**  
Laryngoscope Set, Consists Of Battery Handle ( Without Battery )  
With Four Miller Laryngoscope Blades

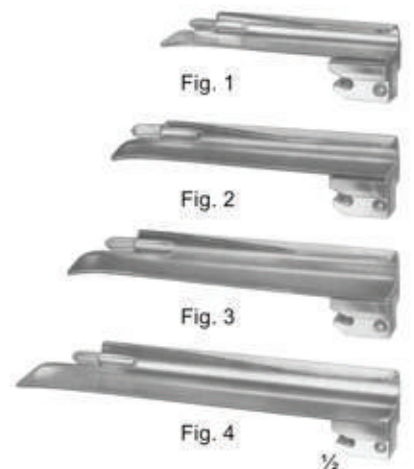

Fig. 1

Fig. 2

Fig. 3

Fig. 4

1/2

- 01-2083 A** Fig. 1 Working Length, 70 mm (Children's)
- 01-2083 B** Fig. 2 Working Length, 90 mm (Adolescent's)
- 01-2083 C** Fig. 3 Working Length, 110 mm (Women's)
- 01-2083 D** Fig. 4 Working Length, 135 mm (Men's)



# Laryngoscopes

# Splenor Surgicals



**01-2084**  
McINTOSH  
Laryngoscope Set, Consists Of Battery Handle ( Without Battery )  
With Three McIntosh Blades, Fig. 1, Fig. 2, Fig. 3

**01-2085**  
McINTOSH  
Laryngoscope Set, Consists Of Battery Handle ( Without Battery )  
With Five McIntosh Blades, Fig. 0, Fig. 1, Fig. 2, Fig. 3, Fig. 4

**01-2086**  
FOREGGER  
Laryngoscope Set, Consists Of  
Battery Handle ( Without Battery )  
With Three Foregger Blades,  
Fig. 1, Fig. 2, Fig. 3.

**01-2087**  
FOREGGER  
Laryngoscope Set, Consists Of  
Battery Handle ( Without Battery )  
With Four Foregger Blades,  
Fig. 1, Fig. 2, Fig. 3, Fig. 4.



**01-2088**  
Fiber Optic  
Battery Handle  
30mm diam.



**01-2089**  
Fiber Optic  
Battery Handle  
18mm diam.



**01-2085 A** Fig. 0 Working Length, 55 mm (Baby's)  
**01-2085 B** Fig. 1 Working Length, 75 mm (Children's)  
**01-2085 C** Fig. 2 Working Length, 90 mm (Adolescent's)  
**01-2085 D** Fig. 3 Working Length, 110 mm (Women's)  
**01-2085 E** Fig. 4 Working Length, 135 mm (Men's)

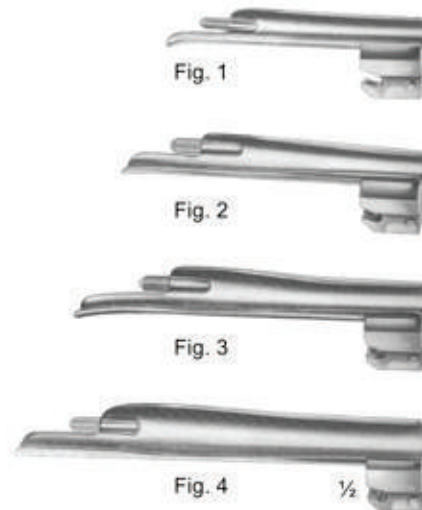

**01-2086 A** Fig. 1 Working Length, 70 mm (Children's)  
**01-2086 B** Fig. 2 Working Length, 90 mm (Adolescent's)  
**01-2086 C** Fig. 3 Working Length, 110 mm (Women's)  
**01-2086 D** Fig. 4 Working Length, 135 mm (Men's)



**01-2090**  
Replacement Lamp  
( Krypton ) 2.5 V



**01-2091**  
Replacement Lamp  
( Halogen ) 2.5 V

# Examination & Measuring Instruments



**01-2092**  
Caliper Of Aluminium  
Graduated in mm & inches  
up to 180mm  
Measuring Range up to 139mm



**01-2093**  
VERNIER  
Universal Caliper Of Steel  
Graduated in mm & inches  
up to 180mm  
Measuring Range up to 120mm  
with Vernier in 1/10mm & 1/16"



**01-2094**  
CARROLL  
Size: 145 mm  
Finger Goniometer



**01-2095**  
TOWNLEY  
Graduated in  
mm & inches  
Size: 115 mm



**01-2096**  
COLLIN  
Druck Pressure 72 kg  
Size: 125 mm



**01-2097**  
BERTILLON  
Caliper For Measuring The Head  
Size: 320 mm



**01-2098**  
CASTROVIEJO  
Caliper  
Size: 75mm



**01-2099**  
MOLTGEN  
Goniometer



**01-2100A**  
Size: 150 mm



**01-2100**  
Size: 500 mm





# Dissecting Knives

*Splenor Surgicals*



**01-2101 - 01-2110**  
Fig. 1 - 10  
With Metal Handle



**01-2101**  
Fig. 1  
Size: 30mm  
15cm



**01-2102**  
Fig. 2  
Size: 36mm  
15cm



**01-2103**  
Fig. 3  
Size: 40mm  
15.5cm



**01-2104**  
Fig. 4  
Size: 45mm  
16cm



**01-2105**  
Fig. 5  
Size: 50mm  
16cm



**01-2106**  
Fig. 6  
Size: 27mm  
15cm



**01-2107**  
Fig. 7  
Size: 35mm  
15cm



**01-2108**  
Fig. 8  
Size: 40mm  
16cm



**01-2109**  
Fig. 9  
Size: 47mm  
16cm



**01-2110**  
Fig. 10  
Size: 50mm  
17cm

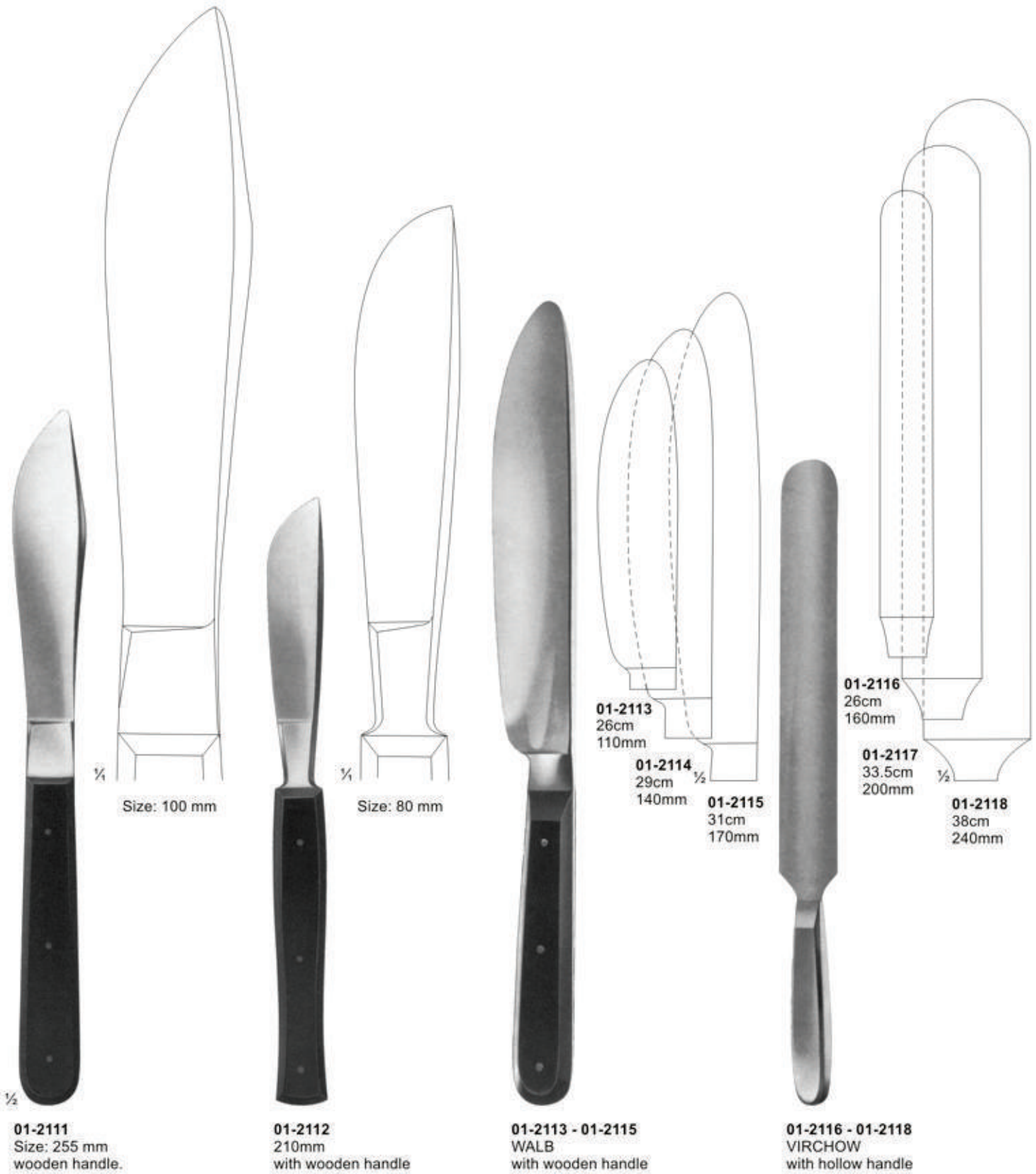

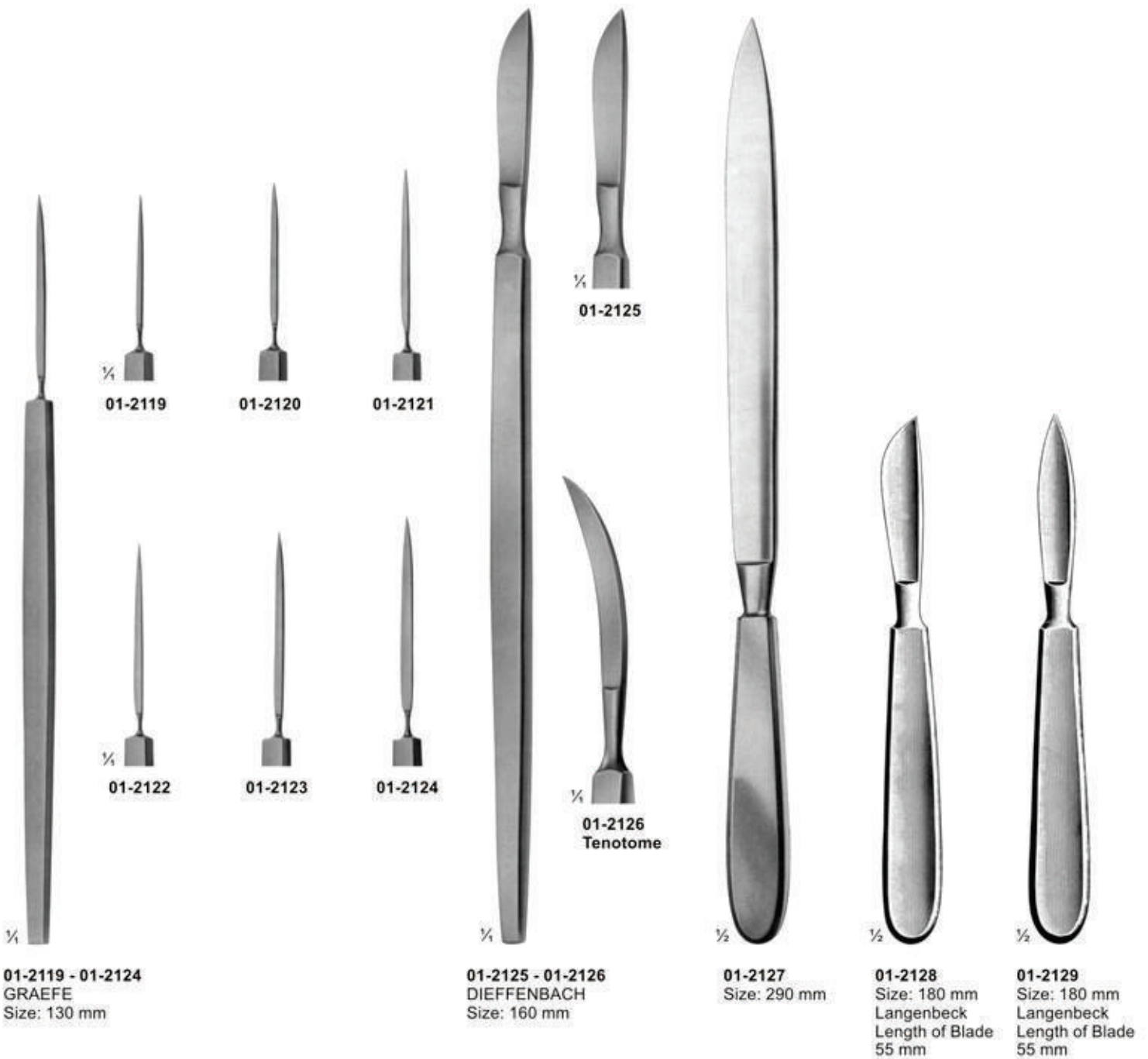

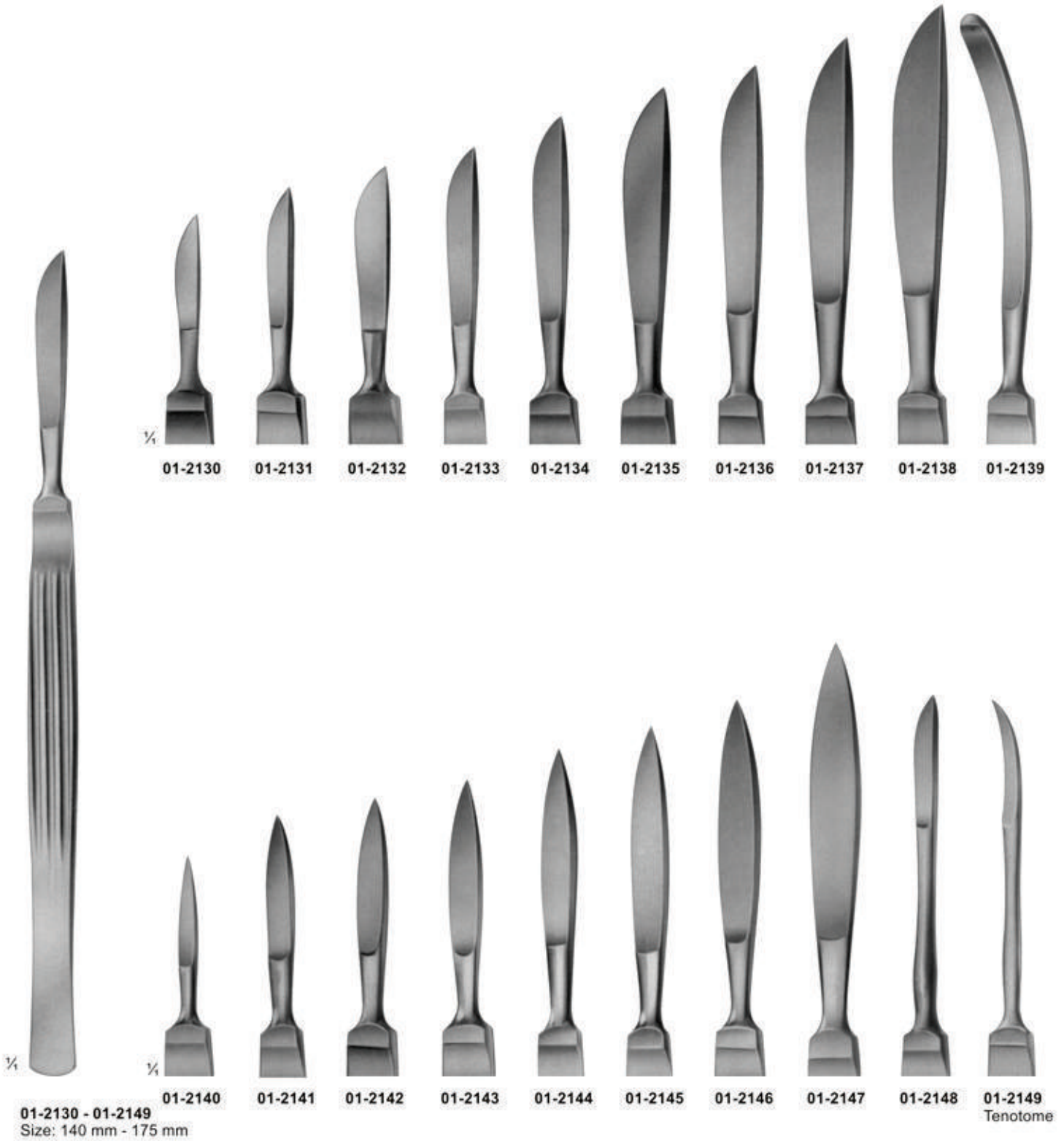



Amputating Knives, Cartilage Knives,  
Autopsy Knives

Double Cutting



Double Cutting

- |   |  |  |   |  |  |   |  |
|---|--|--|---|--|--|---|--|
| <p>LISTON<br/><b>01-2150</b><br/>Size: 130 mm<br/><b>01-2151</b><br/>Size: 160 mm<br/><b>01-2152</b><br/>Size: 190 mm<br/><b>01-2153</b><br/>Size: 220 mm</p> <p>Blade Length<br/>Amputating Knives</p> | <p><b>01-2154</b><br/>CATLIN<br/>Size: 160 mm<br/>Blade Length<br/>Amputating<br/>Knives</p> | <p><b>01-2155</b><br/>LANGENBECK<br/>Size: 120 mm<br/>Blade Length<br/>Flap Knives</p> | <p><b>01-2156</b><br/>Size: 110 mm<br/>Blade Length<br/>Interosseous<br/>Knives</p> | <p><b>01-2157</b><br/>Size: 55 mm<br/>Blade Length<br/>With Raspatory,<br/>Wooden Handle</p> | <p><b>01-2158</b><br/>Size: 70 mm<br/>Blade Length<br/>Wooden Handle</p> | <p><b>01-2159</b><br/>Size: 80 mm<br/>Blade Length<br/>Metal Handle</p> | <p><b>01-2160</b><br/>Size: 195 mm<br/>Blade Length<br/>Metal Handle</p> |
|---|--|--|---|--|--|---|--|



# Cone Knives, Myomatome, Trigeminal & Tonsil Knives

*Splenor Surgicals*



**01-2161**  
AYRE  
Size: 235 mm  
Cone Knife

**01-2162**  
Size: 230 mm  
Cone Knife

**01-2163**  
SEGOND  
Size: 270 mm  
Myomatome

**01-2164**  
OLIVECRONA  
Size: 205 mm  
Trigeminal  
Knife

**01-2165**  
Size: 230 mm  
Trigeminal  
Knife

**01-2166**  
FOWLER  
Size: 200 mm  
Tonsil Knife

**01-2167**  
ABRAHAM  
Size: 215 mm  
Tonsil Knife

**01-2168**  
BRUENINGS  
Size: 215 mm  
Tonsil Knife



# Scalpels, Dura Knives & Comedone Extractors

## Splenor Surgicals



1/4

**01-2169 - 01-2170**  
JOSEPH  
Size: 145 mm  
Double Edged  
Nasal Knives, Pointed



1/4

**01-2169**  
Straight



1/4

**01-2170**  
Curved



1/4

**01-2171 - 01-2173**  
ZIEGLER  
Size: 120 mm  
Milium Knives



1/4

**01-2171**  
Small



**01-2172**  
Large



**01-2173**  
Pointed



1/4

**01-2174**  
VIDAL  
Lupus Scraper  
Size: 135 mm



1/4

blade  
only

**01-2175**  
MONCORPS  
Milium Knives  
Size: 130 mm



1/4

**01-2176**  
SAALFELD  
Size: 100 mm

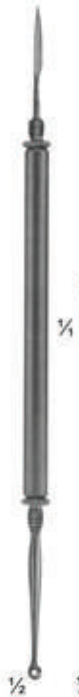

1/4

**01-2177**  
HEBRA  
Size: 180 mm



1/4

**01-2178**  
Size: 145 mm



1/4

**01-2179**  
UNNA  
Size: 145 mm

# Razor Blade Holders & Breakers

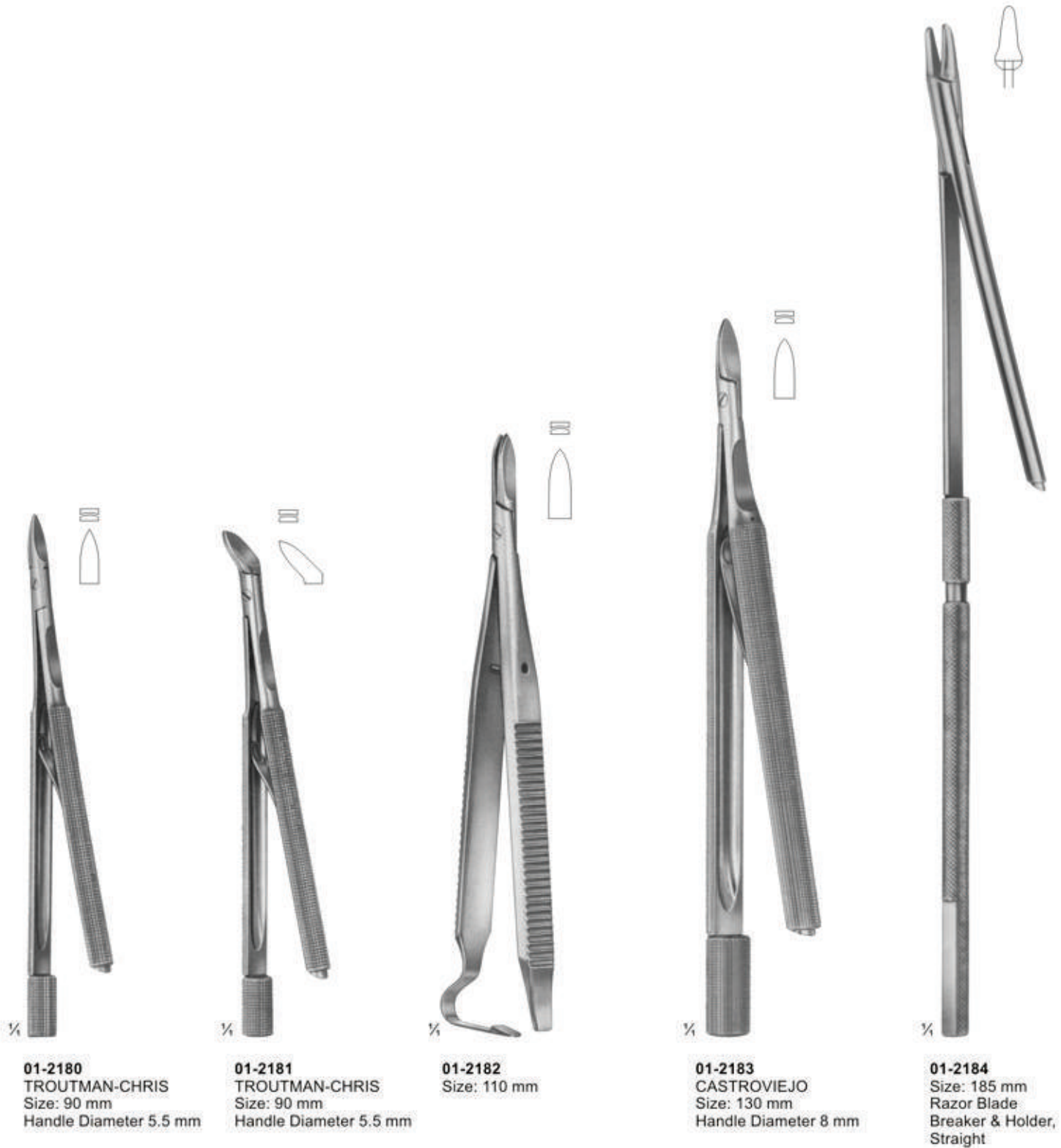



# Scalpel Handles

*Splenor Surgicals*



**01-2185**  
STANDARD  
No. 4  
Solid

**01-2186**  
Double Handle  
No. 4 + No. 3  
Solid

**01-2187**  
No. 4 L  
Straight  
Solid

**01-2188**  
No. 4 L  
Solid Angled

**01-2189**  
COLLIN  
No. 8  
Hollow

**01-2190**  
COLLIN  
No. 9  
Hollow

**01-2191**  
Plastic  
No.4



# Scalpel Handles

Splenor Surgicals



**01-2192**  
STANDARD  
No. 3  
Solid  
Size:12cm

**01-2193**  
No. 3  
Solid  
Size:12cm  
solid handle  
style as  
No.4

**01-2194**  
No. 3  
Solid  
Size:12cm  
cm-graduation

**01-2195**  
No. 3 L  
Straight  
Solid, long  
Size:21.5cm

**01-2196**  
No. 3 L  
Angled  
Solid, long  
Size:21cm

**01-2197**  
No. 7  
Solid  
Size:16cm

**01-2198**  
No. 7 K  
Solid, short  
Size:12.5cm

**01-2199**  
No.3  
Size:15.5cm  
with round  
hollow handle

**01-2200**  
No. 3  
Straight  
Solid,  
Round  
Size:14.5cm

**01-2201**  
No. 3  
Angled  
Solid, Round  
Size:14cm



# Razors & Dermatomes

*Splenor Surgicals*



1/2

**01-2202**  
SCHINK  
Size: 310 mm  
Complete with 2  
skin fixing plates  
and 1 blade.  
Adjustable from  
0.1 to 2.0mm



1/2

**01-2203**  
SCHINK  
Spare Blade



1/2

**01-2204**  
SCHINK  
Skin Fixing Plate



1/2

**01-2205**  
SILVER  
Size: 190 mm  
For Usual  
Razor Blades



1/2

**01-2206**  
Size: 75 mm  
Cutting Length



1/2

**01-2207**  
Size: 80 mm  
Cutting Length



# Micro Forceps, Jeweler Types and Micro Suture Tying Forceps

## Splenor Surgicals

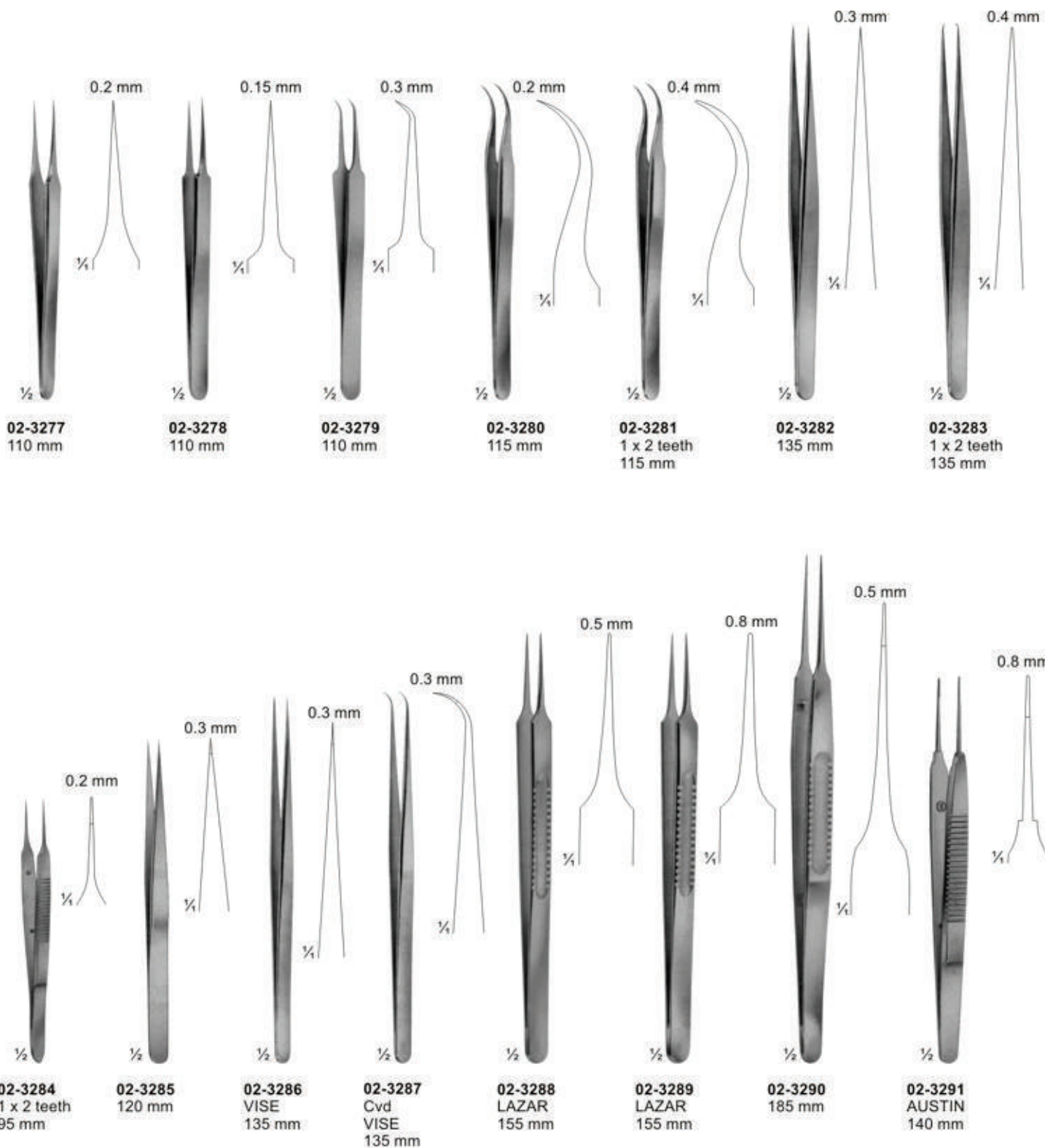





# Micro Forceps, Ligature Forceps (Light Patterns) Bayonet - Shaped

*Splenor Surgicals*

0.15 mm 0.20 mm 0.30 mm 0.50 mm

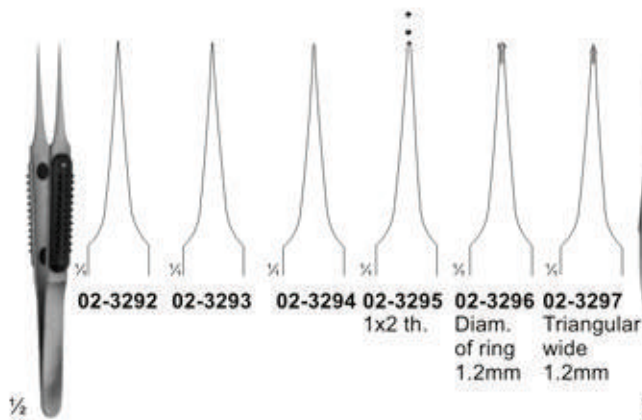

02-3292 02-3293 02-3294 02-3295 02-3296 02-3297  
1x2 th. Diam. Triangular  
of ring wide  
1.2mm 1.2mm

02-3292 - 02-3297  
MULLER  
110 mm



02-3298  
LIGATURE  
FORCEPS  
220 mm



02-3299  
YASARGIL  
Ligature forceps  
185 mm



02-3300 - 02-3302  
MICRO FORCEPS  
Ligature pattern  
185 mm



0.6 mm 0.9 mm  
02-3303 02-3304 02-3305  
1x2 teeth

02-3303 - 03-3305  
YASARGIL  
180 mm



0.6 mm 0.9 mm  
02-3306 02-3307

02-3306 - 02-3307  
YASARGIL  
200 mm



02-3308 - 03-3309  
YASARGIL  
220 mm



02-3310 - 02-3311  
YASARGIL  
240 mm





# Forceps for Grasping Tissue, Tumors, Bayonet Shaped

*Splenor Surgicals*



**02-3312 - 02-3314**  
YASARGIL-SAMII  
Jaws Spoon-Shaped  
240 mm



**02-3315 - 02-3316**  
YASARGIL  
Jaws Spoon-Shaped  
220 mm



**02-3317 - 02-3319**  
SAMII  
Jaws Spoon-Shaped  
230 mm



**02-3320 - 02-3322**  
SAMII  
Jaws Spoon-Shaped  
230 mm

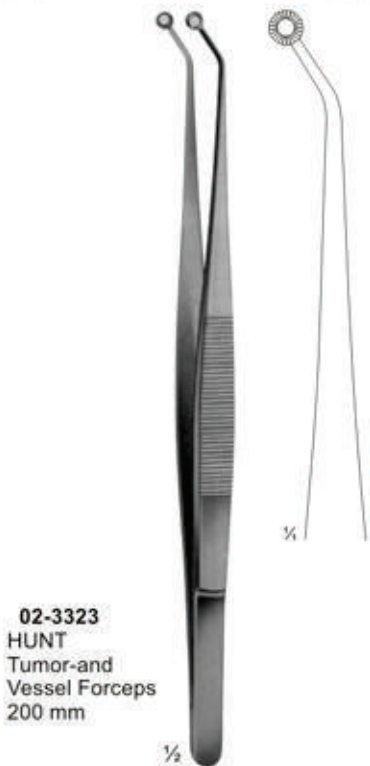

**02-3323**  
HUNT  
Tumor-and  
Vessel Forceps  
200 mm



**02-3324**  
HUNT  
Tumor-and  
Vessel Forceps  
200 mm



**02-3325**  
YASARGIL  
Tumor-and  
Vessel Forceps  
200 mm



**Delicate Dissecting, Microscopic,  
Sterilizing Forceps**

*Splenor Surgicals*

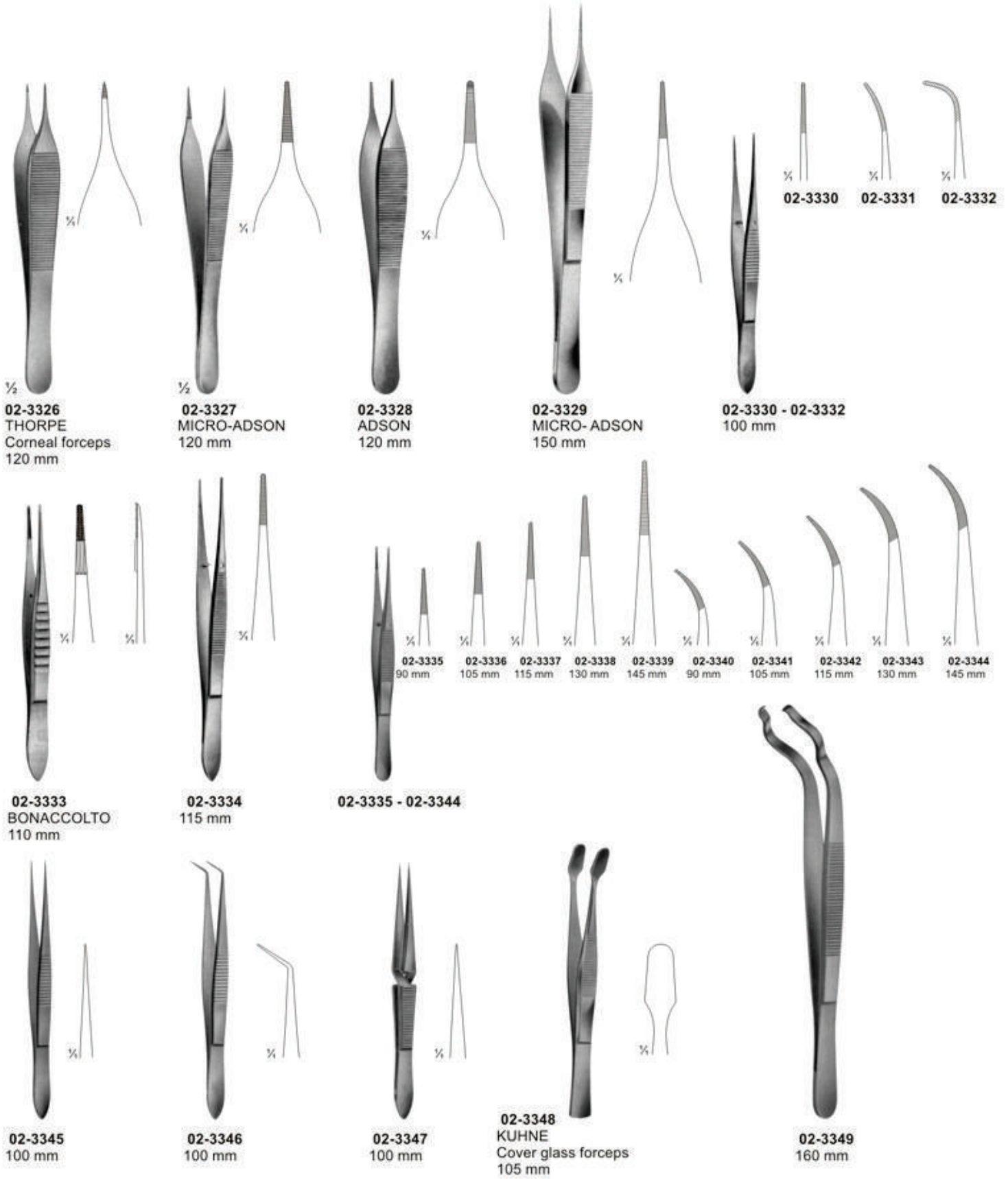



# Delicate Dissecting Forceps

*Splenor Surgicals*

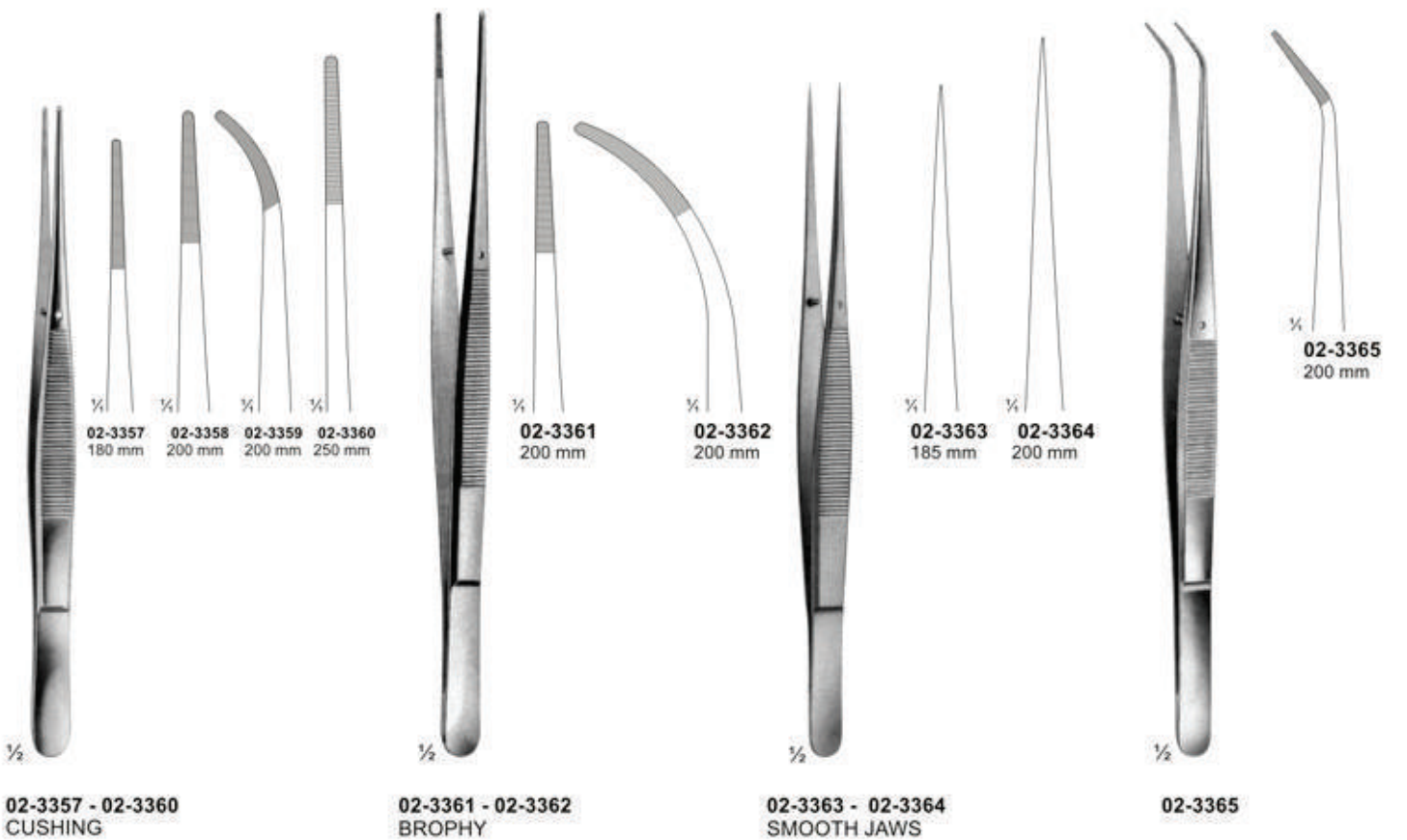
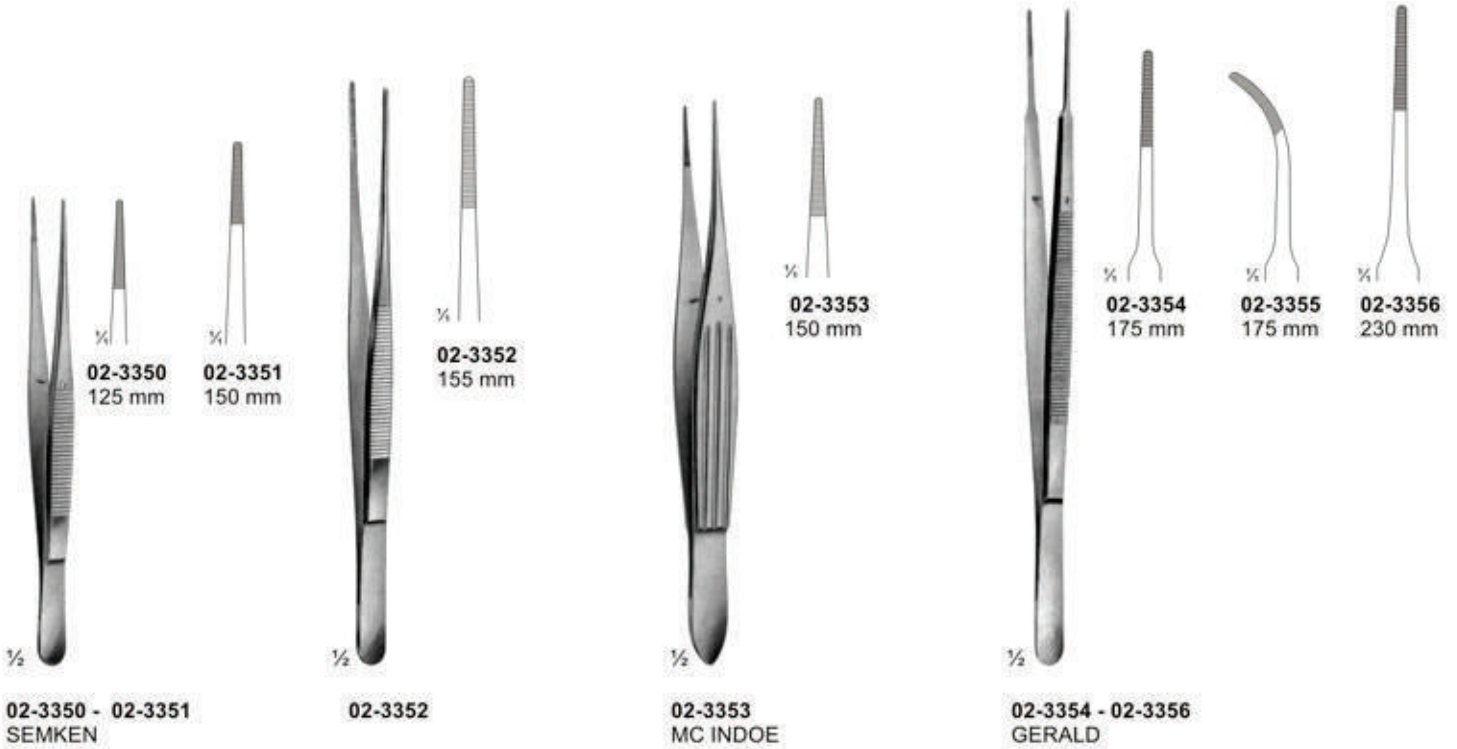



# Dissecting Forceps

*Splenor Surgicals*



1/2

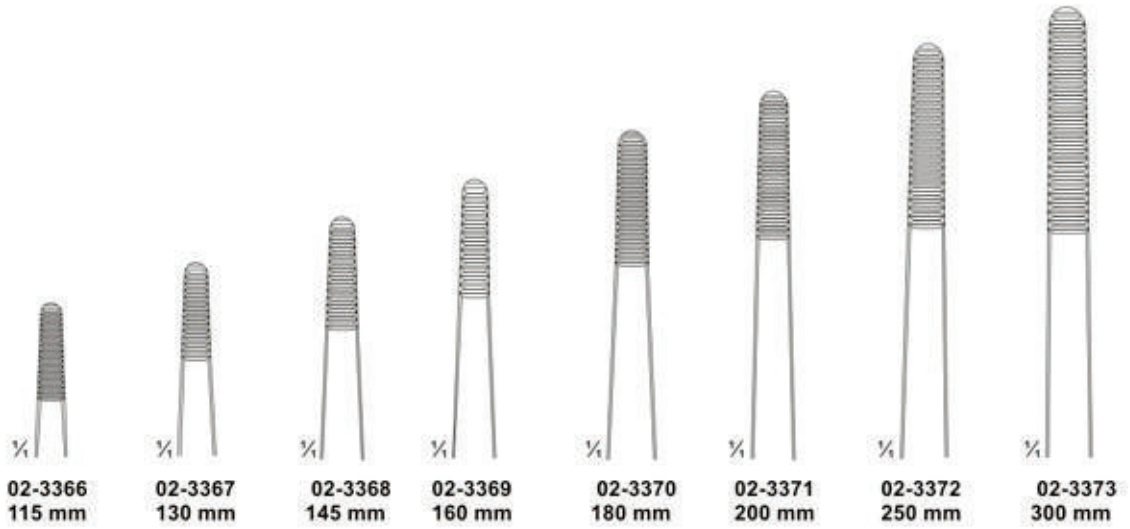

02-3366  
115 mm

02-3367  
130 mm

02-3368  
145 mm

02-3369  
160 mm

02-3370  
180 mm

02-3371  
200 mm

02-3372  
250 mm

02-3373  
300 mm

02-3366 - 03-3373  
STANDARD



1/2

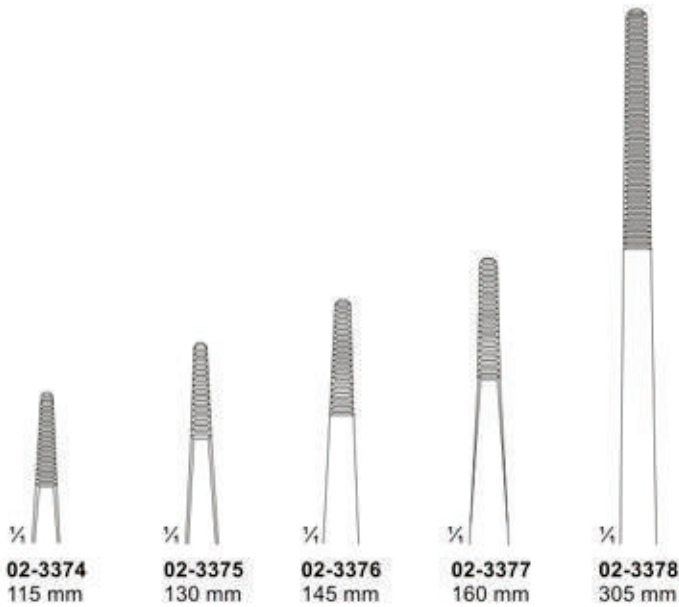

02-3374  
115 mm

02-3375  
130 mm

02-3376  
145 mm

02-3377  
160 mm

02-3378  
305 mm

02-3374 - 02-3378  
MEDIUM



1/2



02-3379  
130 mm

02-3380  
145 mm

02-3379 - 02-3380  
MEDIUM



# Dissecting Forceps

Splenor Surgicals



02-3381  
125 mm



02-3382  
155 mm



02-3383  
130 mm



02-3384  
150 mm



02-3385  
170 mm



02-3386  
200 mm

02-3381 - 02-3382

02-3383 - 02-3386  
Swedish pattern



02-3387  
OCHSNER  
Ligature forceps  
145mm



02-3388  
FRICKE  
Artery forceps  
130mm



03-3389  
BONNEY  
175mm



# Ultra-Light Forceps ATRAUMATA

*Splenor Surgicals*

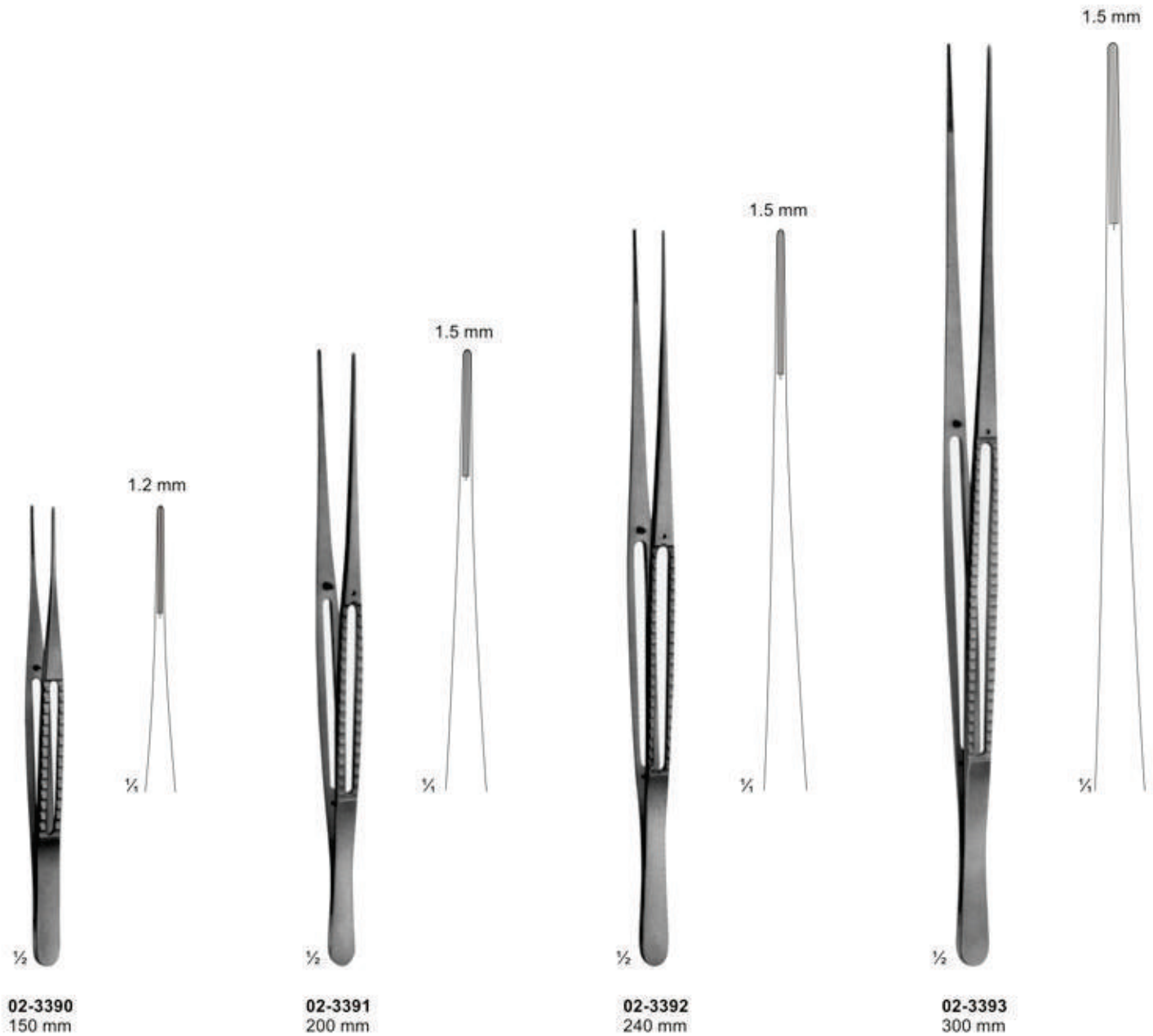

# Forceps ATRAUMATA

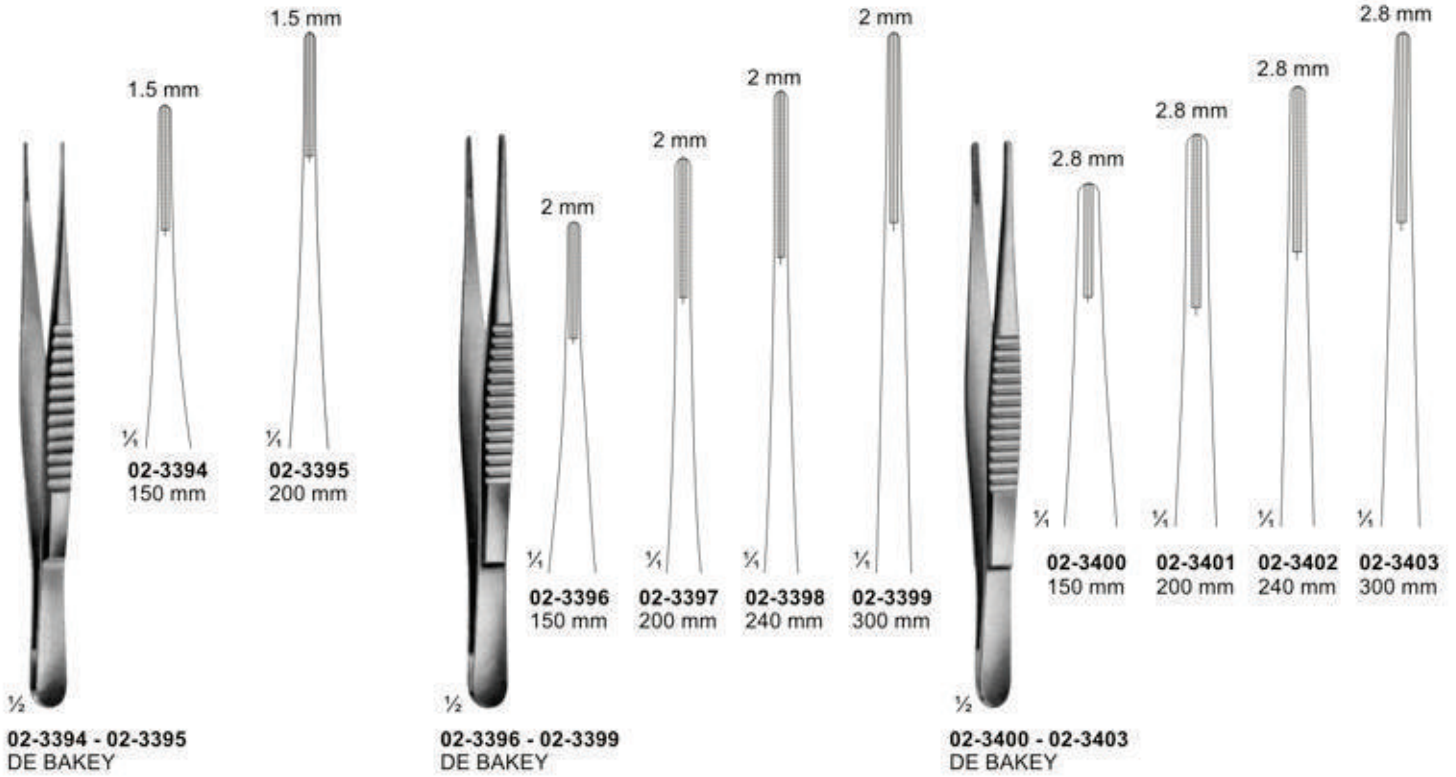





# Forceps, Bayonet - Shaped, Angular

*Splenor Surgicals*



**02-3409**  
LUCAE  
140 mm



**02-3410**  
LUCAE  
1x2 teeth  
140 mm



**02-3411**  
COTTLE  
Forceps with  
jaws toothed  
and serrated  
140 mm



**02-3412**  
JANSEN  
160 mm



**02-3413**  
GRUENWALD  
200 mm



**02-3414**  
1x2 teeth  
200 mm



**02-3415**  
TROELTSCH  
100 mm



**02-3416**  
TROELTSCH  
115 mm

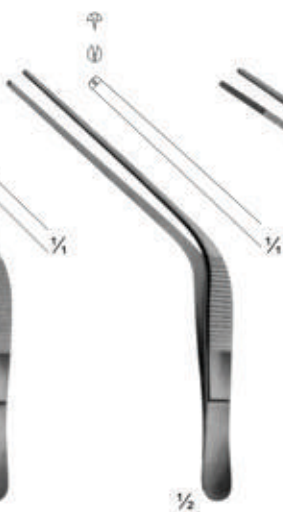

**02-3417**  
TROELTSCH  
1X2 teeth  
115 mm

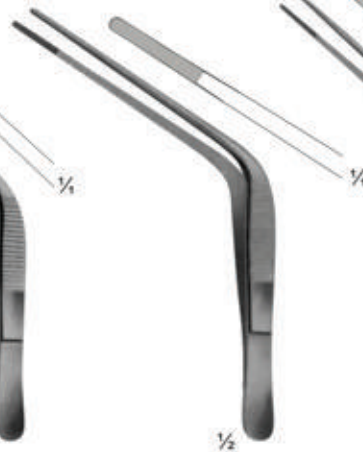

**02-3418**  
WILDE  
115 mm

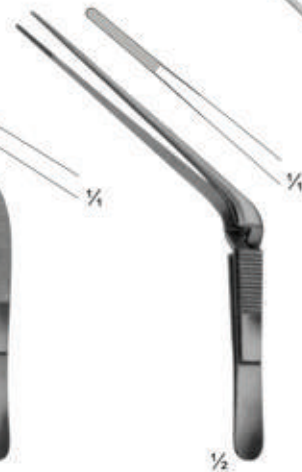

**02-3419**  
TROELTSCH  
Cross action  
120 mm



**02-3420**  
TROELTSCH  
140 mm



# Delicate Tissue Forceps

# Splenor Surgicals



**02-3421**  
BISHOP-HARMON  
85 mm

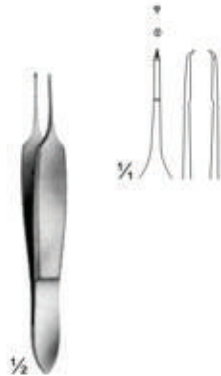

**02-3422**  
ST. MARTIN  
80 mm



**02-3423**  
CASTROVIEJO  
teeth 0.9 mm  
100 mm



**02-3424**  
CASTROVIEJO  
teeth 0.5 mm  
100 mm



**02-3425**  
ELSCHING  
110 mm



**02-3426**  
GILL  
75 mm



**02-3427**  
GILL - HESS  
75 mm

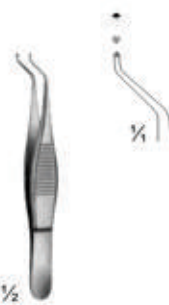

**02-3428**  
HESS  
70 mm



**02-3429**  
ARRUGA  
100 mm

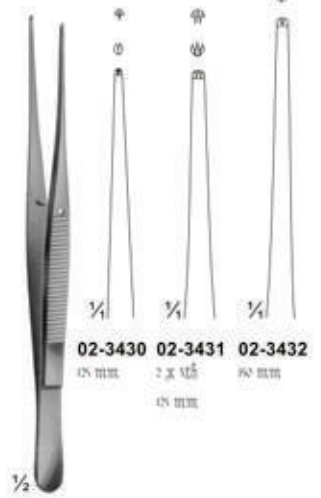

**02-3430 - 02-3432**  
SEMKEN



**02-3433**  
MICRO-ADSON  
120 mm

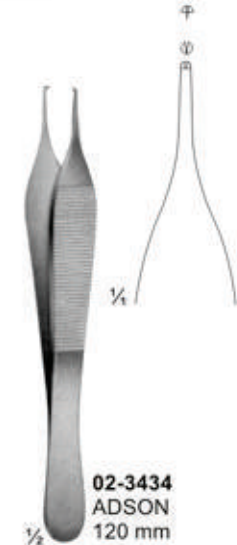

**02-3434**  
ADSON  
120 mm



**02-3435**  
ADSON  
120 mm



**02-3436**  
ADSON  
120 mm

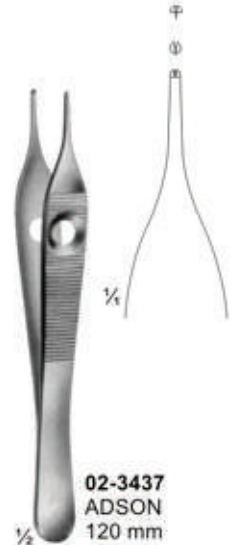

**02-3437**  
ADSON  
120 mm



# Tissue Forceps

# Splenor Surgicals



**02-3438**  
ADSON - BROWN  
Non-traumatic  
120 mm



**02-3439**  
BROWN  
150 mm



**02-3440**  
GRAEFE  
110 mm



**02-3441**  
GRAEFE  
With Catch  
110 mm

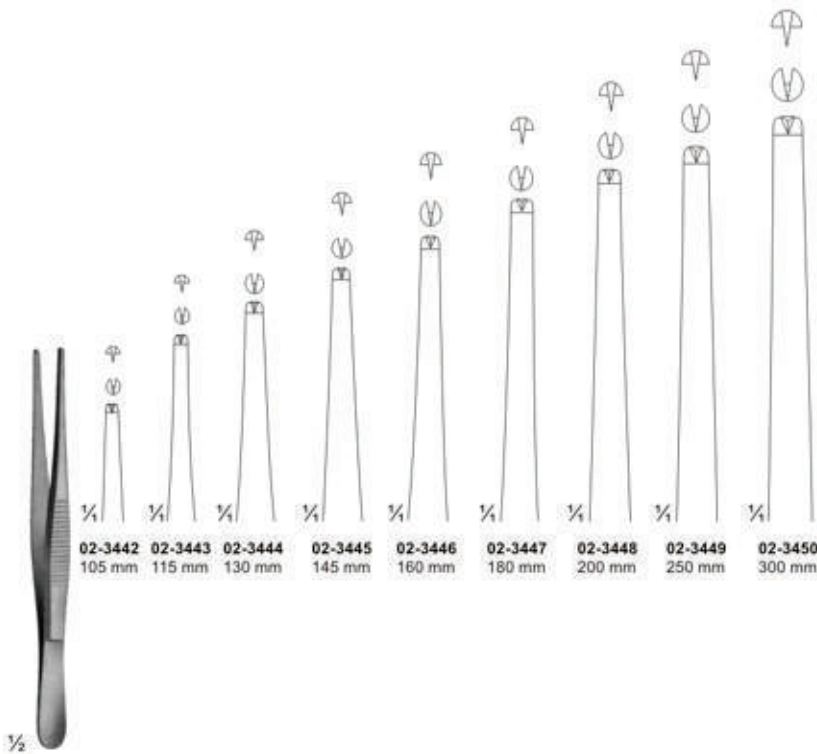

**02-3442 - 02-3450**  
STANDARD

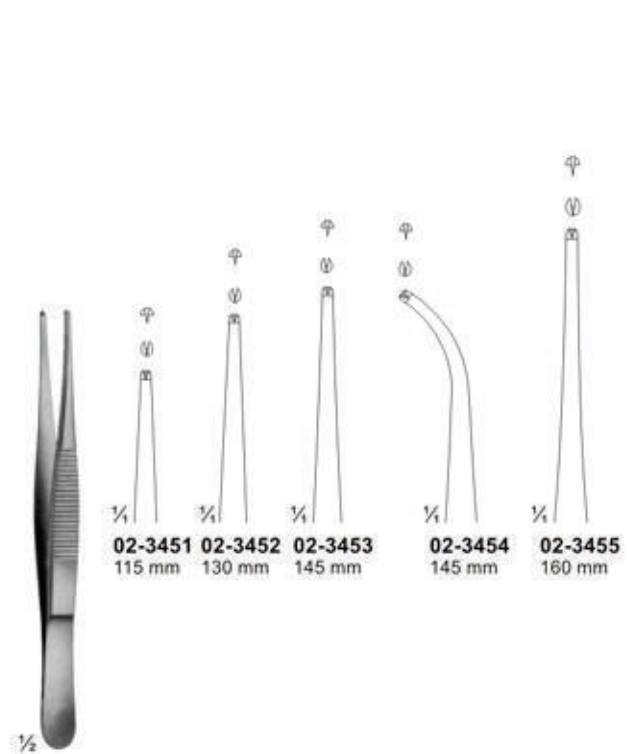

**02-3451 - 02-3455**  
Medium

# Tissue Forceps

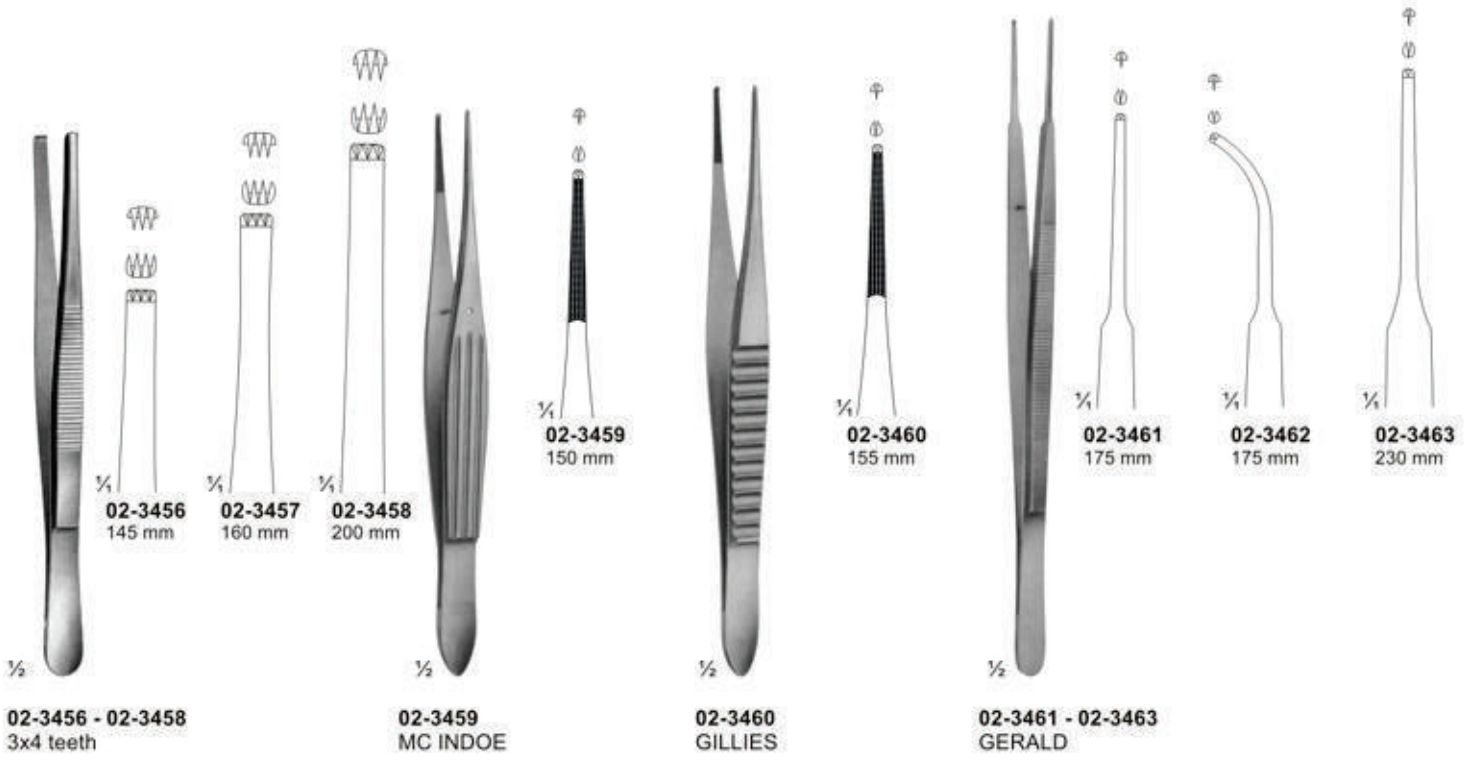

**02-3456 - 02-3458**  
3x4 teeth

**02-3459**  
MC INDOE

**02-3460**  
GILLIES

**02-3461 - 02-3463**  
GERALD



**02-3464 - 02-3467**  
WAUGH

**02-3468**  
BROPHY



# Tissue Forceps, Lung Dissecting Forceps, Intestinal Forceps

*Splenor Surgicals*

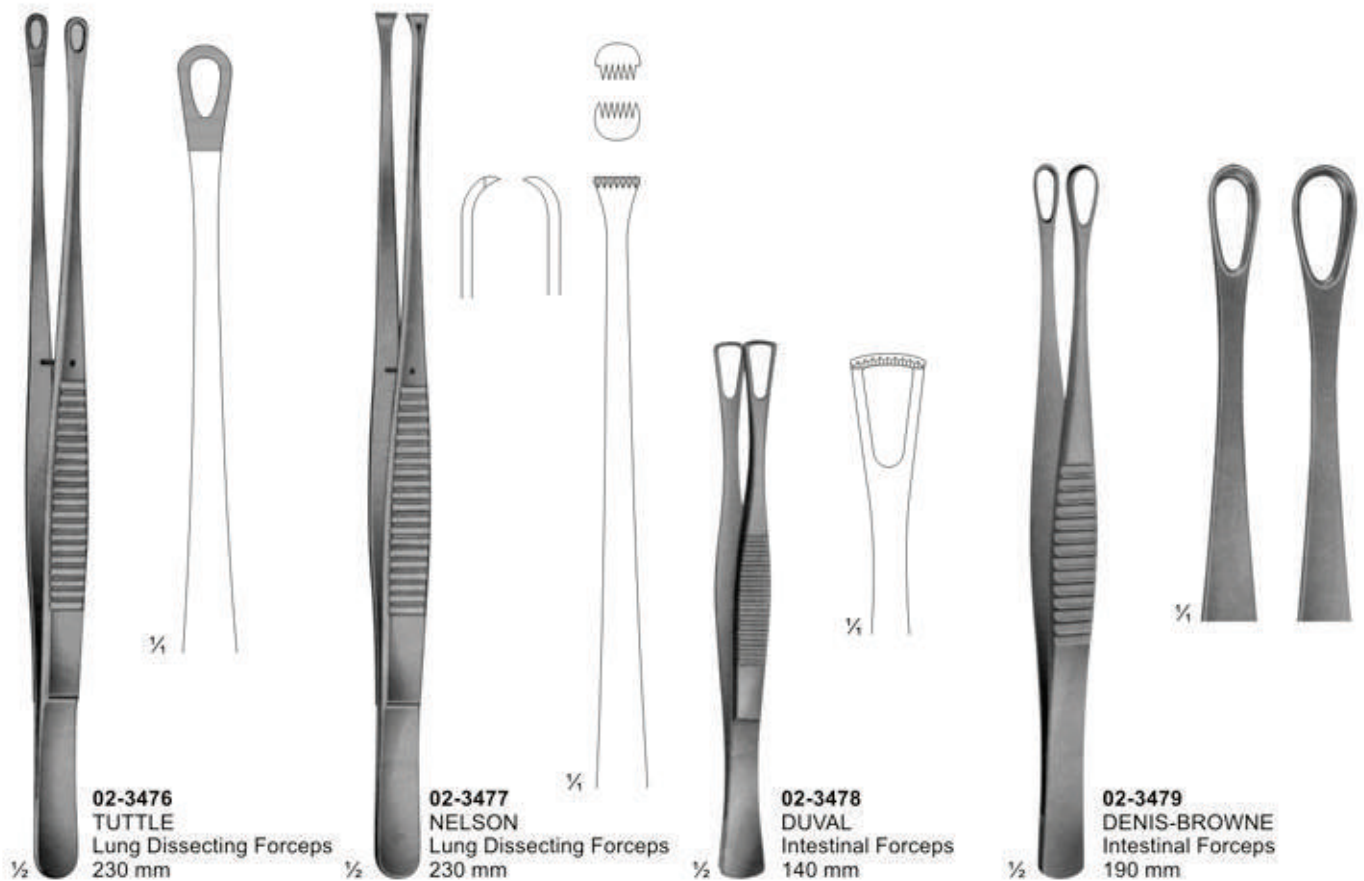
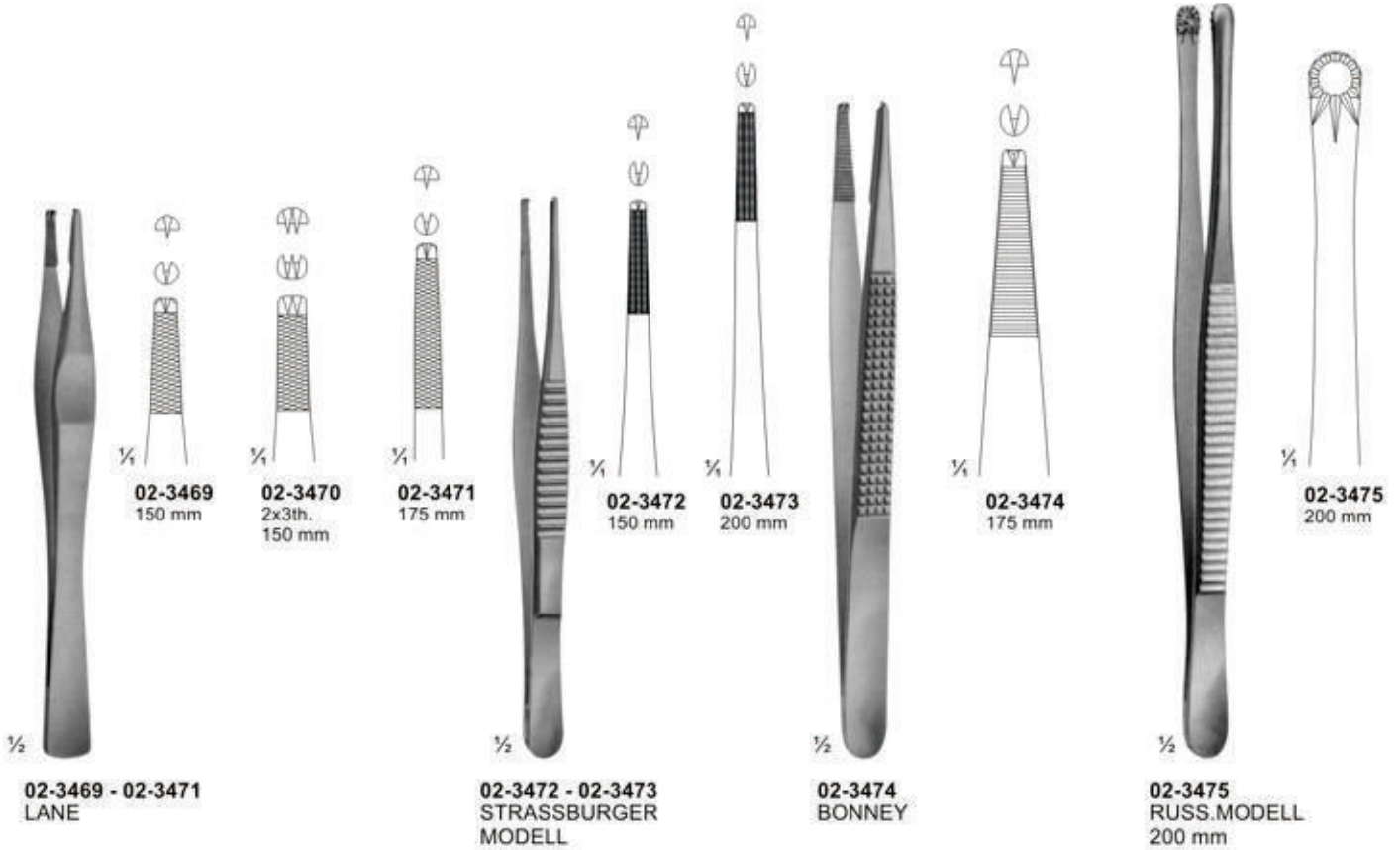



# Splinter and Cilia Forceps

*Splenor Surgicals*





# Sponge and Dressing Forceps

*Splenor Surgicals*



**02-3496  
BRYANT**  
130 mm



**02-3497 - 02-3499**  
LISTER  
Sinus Forceps

**02-3497 02-3498 02-3499**  
130 mm 155 mm 175 mm

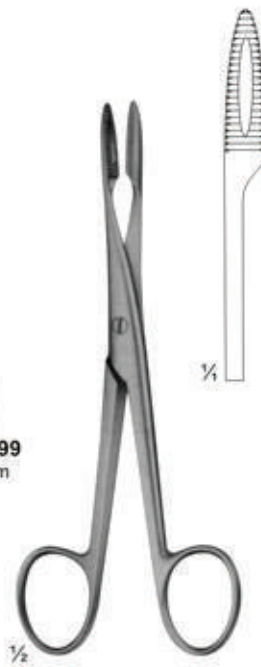

**02-3500**  
Without Ratchet  
145 mm

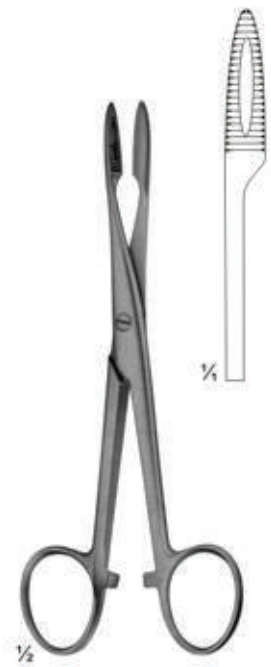

**02-3501**  
With Ratchet  
145 mm



**02-3502 - 02-3503**  
GROSS  
Without Ratchet  
180 mm

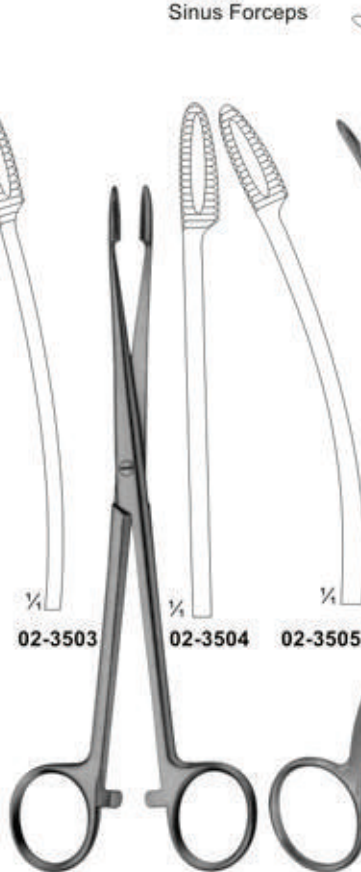

**02-3504 - 02-3505**  
GROSS  
With Ratchet  
180 mm

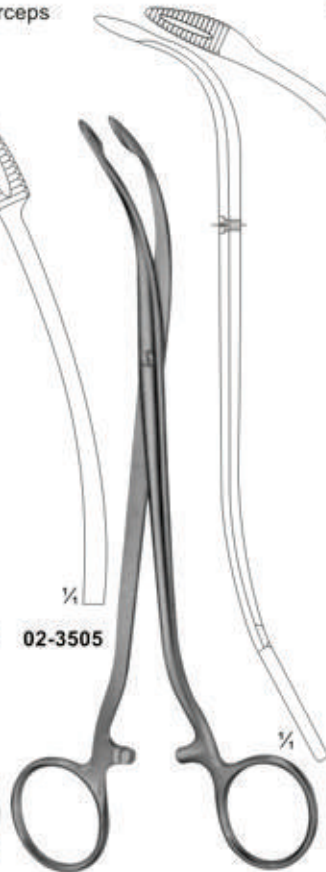

**02-3506**  
DUPLAY  
190 mm

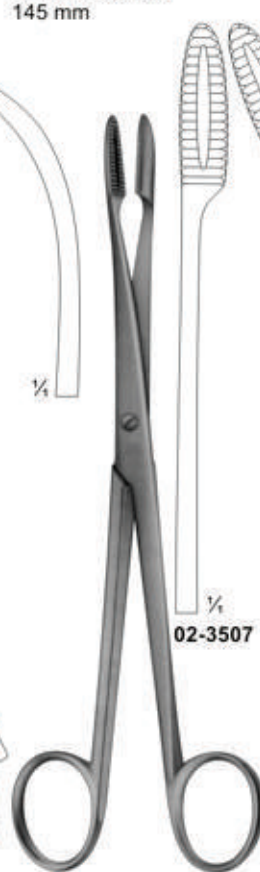

**02-3507 - 02-3508**  
GROSS  
Without Ratchet  
200 mm

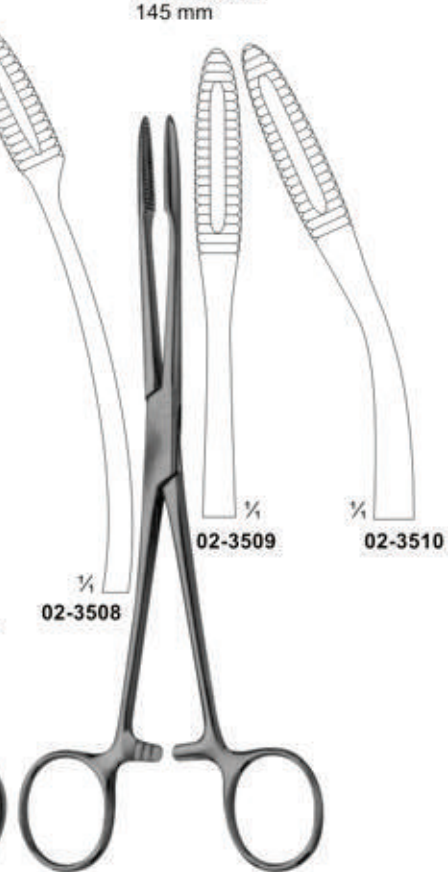

**02-3509 - 02-3510**  
GROSS  
With Ratchet  
200 mm



# Sponge and Dressing Forceps

*Splenor Surgicals*

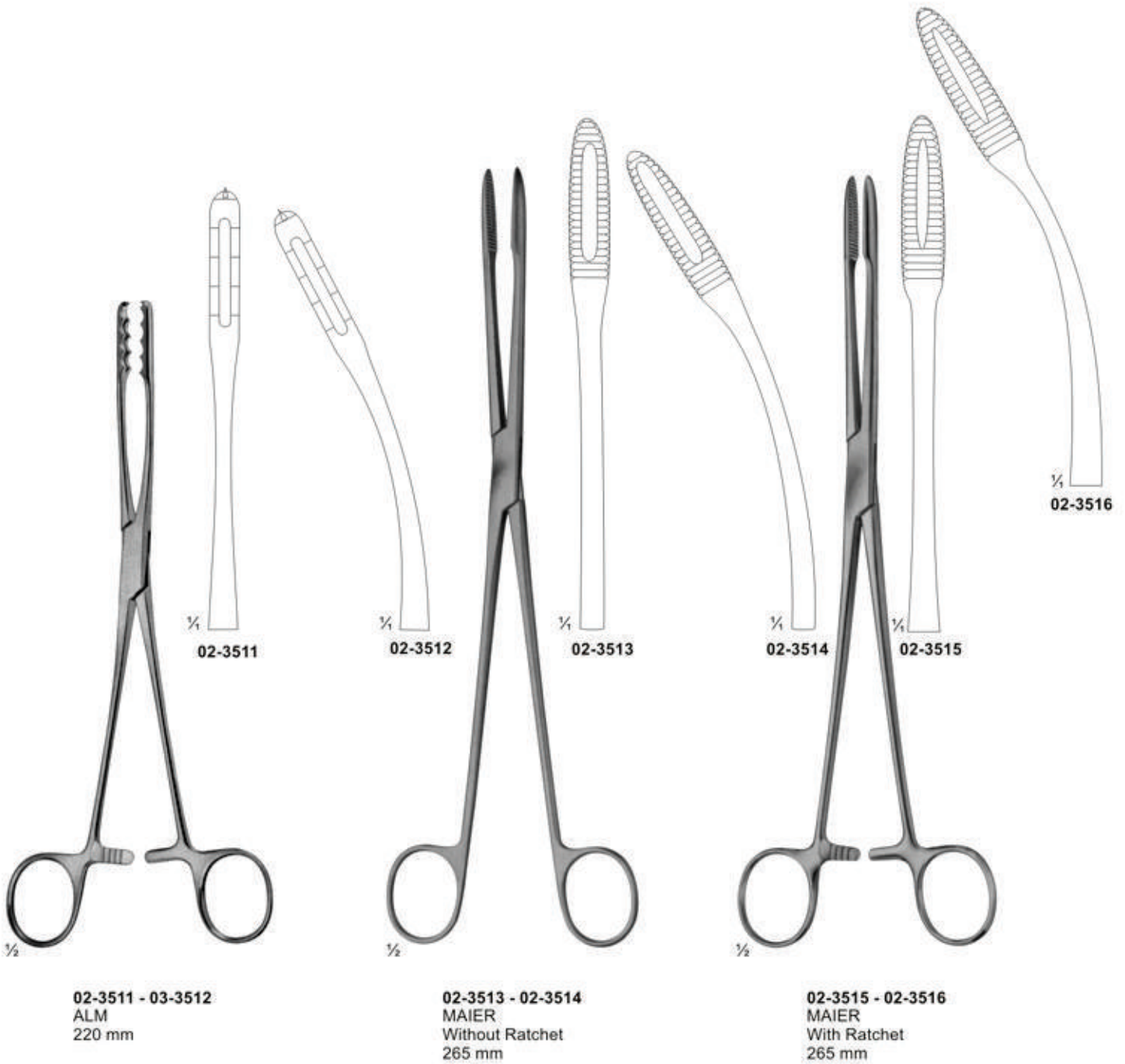



# Sponge and Dressing Forceps



02-3517

02-3518

**02-3517 - 02-3518**  
SIMS-MAIER  
280 mm

**02-3519**  
COLLIN  
240 mm

**02-3520**  
CHERON  
Handles Laterally Angled  
240 mm

**02-3521**  
EMMET  
210 mm



Dressing, Sponge Holding, Organ and Tissue Grasping Forceps and Haemostatic Forceps *Splenor Surgicals*

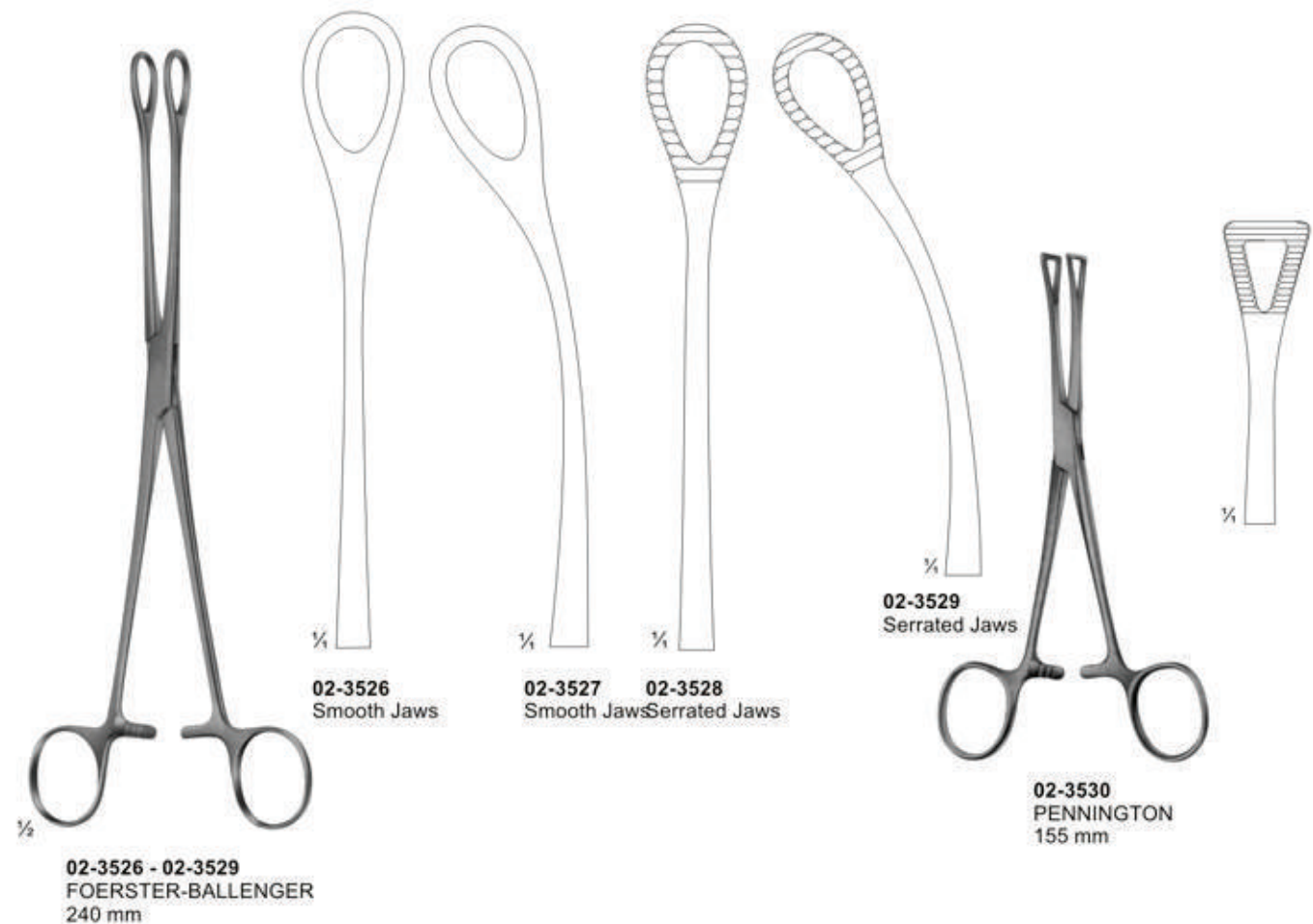
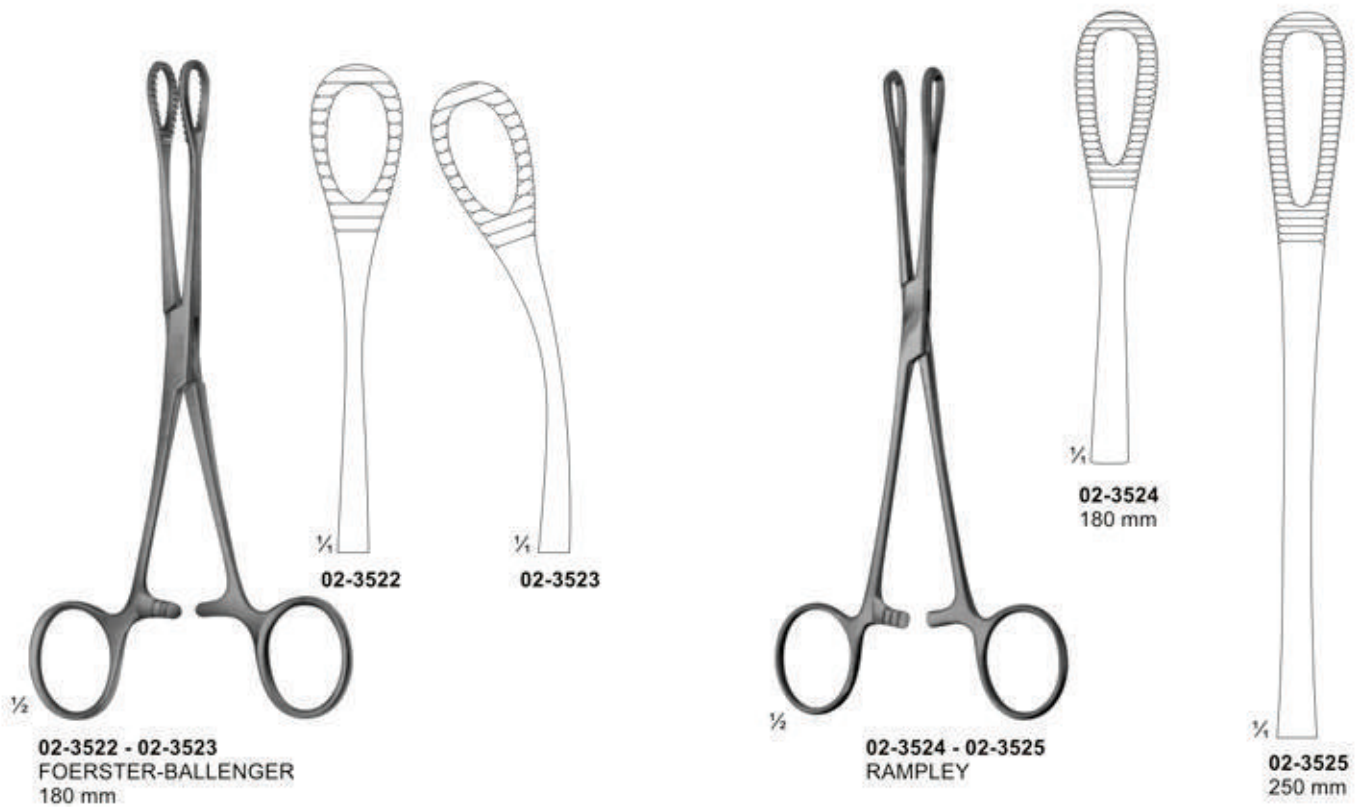



# Dressing, Sponge holding, Organ and Tissue Grasping Forceps

*Splenor Surgicals*

ATRAUMATA



02-3531 - 02-3532  
COLLIN



1/2  
02-3531  
195 mm



1/2  
02-3532  
230 mm



02-3533 - 02-3535  
COLLIN



1/2  
02-3533  
160 mm



1/2  
02-3534  
160 mm



1/2  
02-3535  
170 mm



02-3536  
HEYWOOD-SMITH  
200 mm



02-3537  
NOTO  
280 mm

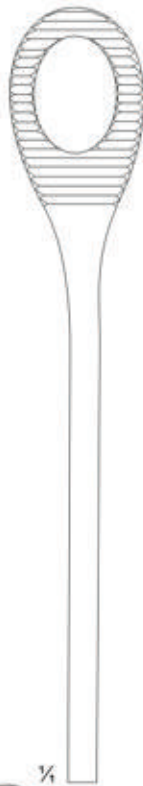

1/2



02-3538  
KELLY  
320 mm



1/2



# Tendon Seizing Forceps

*Splenor Surgicals*



02-3539

02-3540



02-3541

1/2  
02-3539 - 02-3540  
HERZ  
155 mm

1/2  
02-3541  
JACKSON  
4 x 5 teeth  
150 mm



1/2  
02-3542  
Tendon interlacing  
forceps  
150 mm



1/2  
02-3543  
Tendon interlacing  
forceps  
150 mm

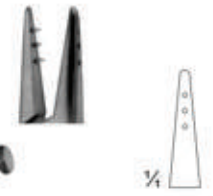

1/2  
02-3544  
Tendon seizing  
forceps  
120 mm

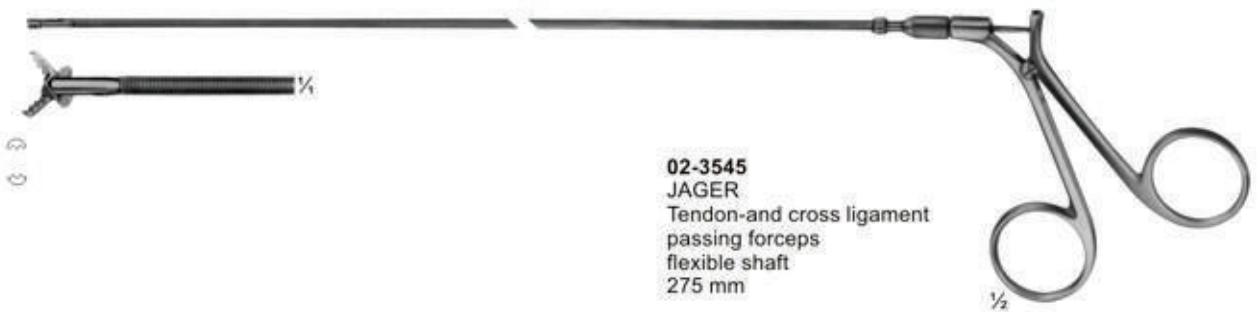

02-3545  
JAGER  
Tendon-and cross ligament  
passing forceps  
flexible shaft  
275 mm



Artery Traction - and Tissue Grasping Forceps

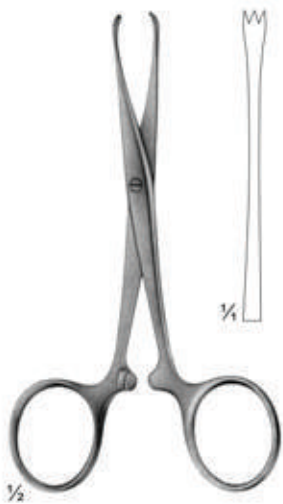

02-3546  
CHAPUT  
2 x 3 teeth sharp  
125 mm

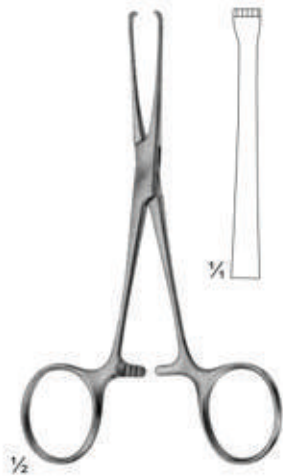

02-3547  
BABY-ALLIS  
4 x 5 teeth  
130 mm



02-3548  
BOYS-ALLIS  
5 x 6 teeth sharp  
155 mm

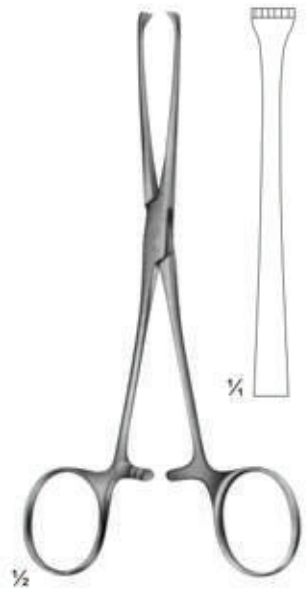

02-3549  
ALLIS  
5 x 6 teeth blunt  
155 mm



02-3550  
LAHEY  
155 mm

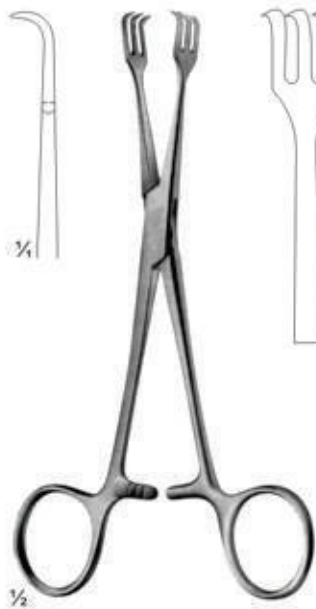

02-3551  
LAHEY  
155 mm

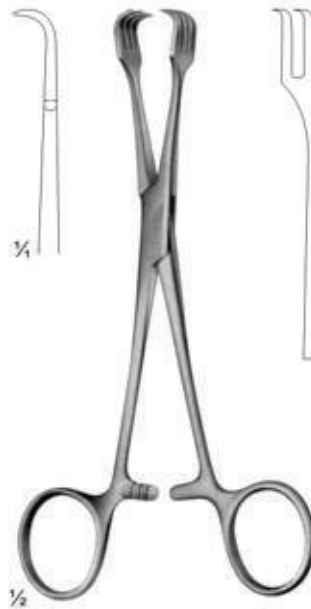

02-3552  
BRAUN  
155 mm

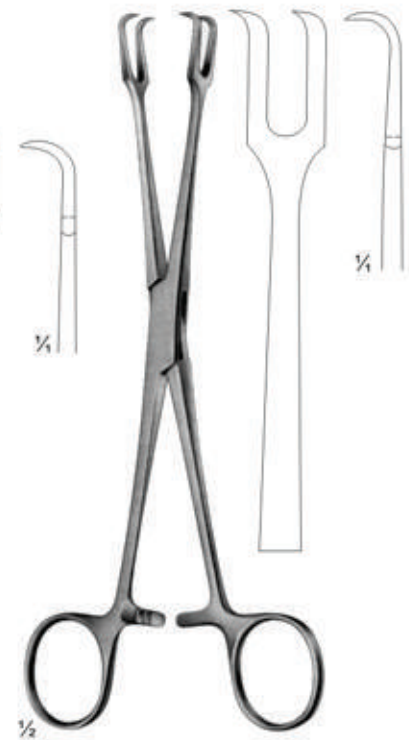

02-3553  
MUSEUX  
200 mm



# Organ - and Tissue Grasping Forceps

*Splenor Surgicals*

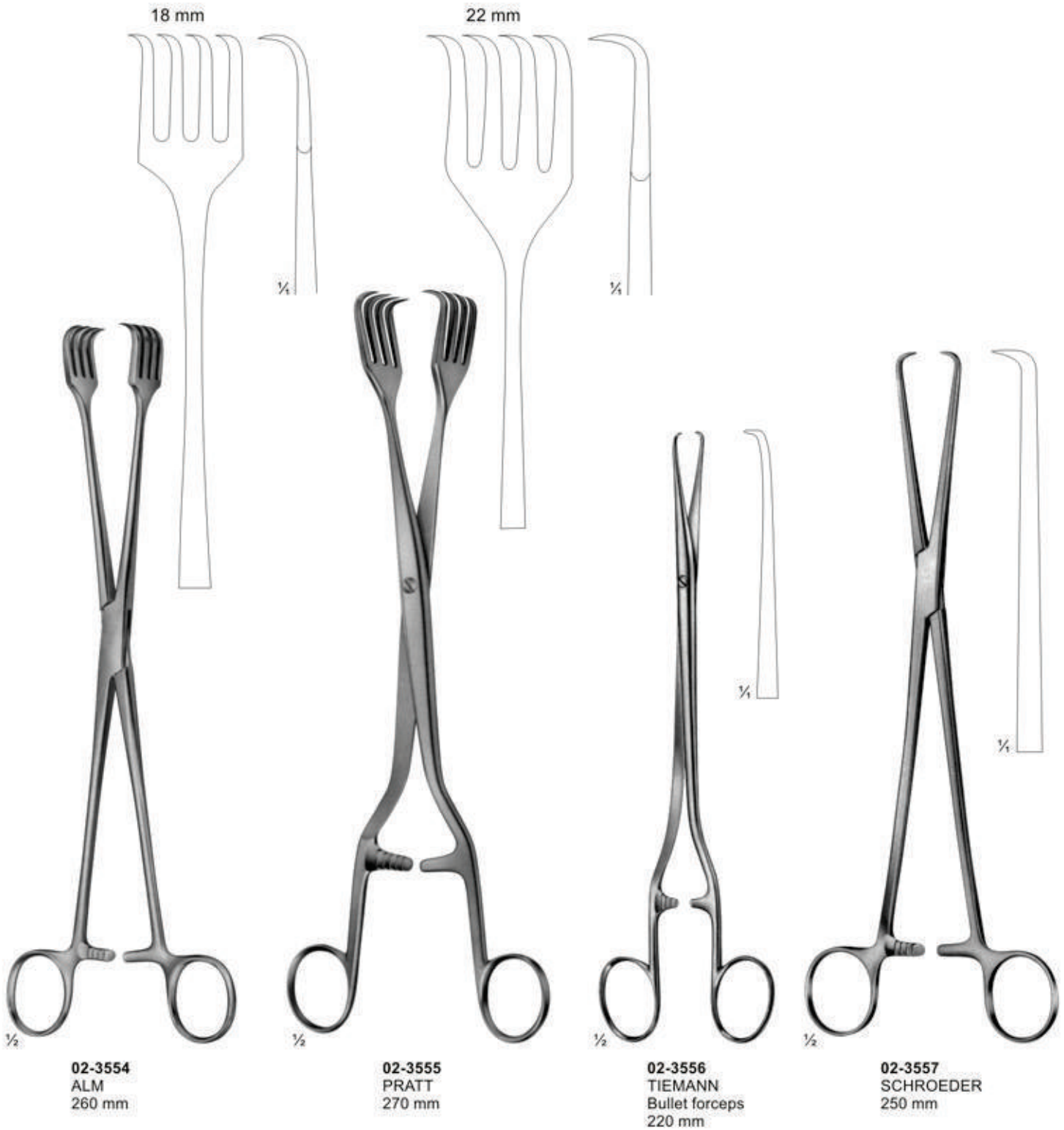

# Towel Clamps



**02-3558**  
JONES  
85 mm



**02-3559**  
ENGL. MOD.  
85 mm



**02-3560 - 02-3561**  
SCHAEFFEL  
85 mm



**02-3562**  
DOYEN  
110 mm



**02-3563**  
DOYEN  
180 mm

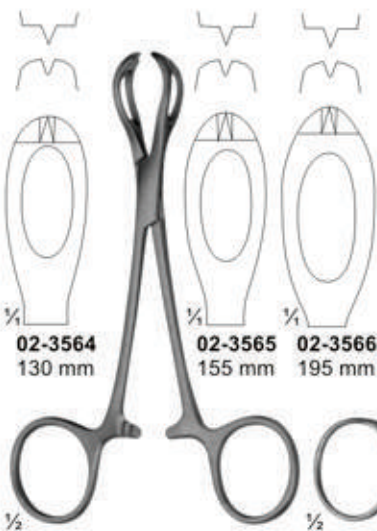

**02-3564**  
130 mm

**02-3565**  
155 mm

**02-3566**  
195 mm

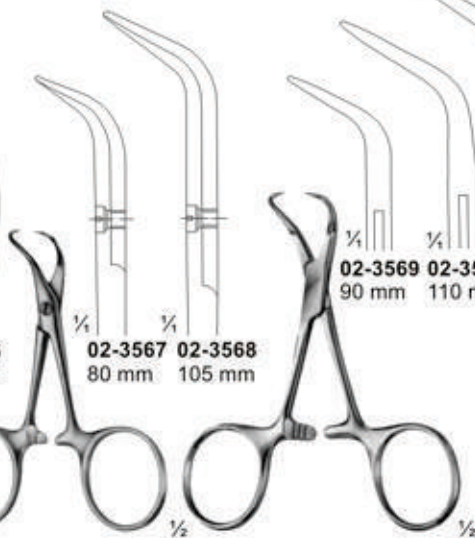

**02-3567**  
80 mm

**02-3568**  
105 mm

**02-3569 02-3570 02-3571**  
90 mm 110 mm 135 mm

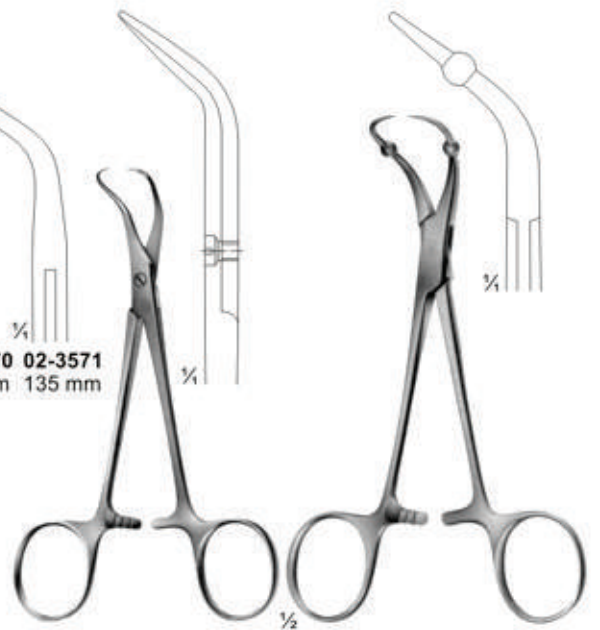

**02-3572**  
BACKHAUS-KOCHER  
135 mm

**02-3573**  
ROEDER  
160 mm



# Towel Clamps and Safety Pins.

*Splenor Surgicals*



**02-3574**  
ROBIN  
with holders for tubing  
up to 13 mm  
135 mm



**02-3575**  
with clip for tubing  
up to 15 mm  
110 mm



**02-3576**  
LORNA  
non perforating  
130 mm



**02-3577**  
for paper cloths  
140 mm



**02-3578**  
BUNT  
105 mm



**02-3579**  
MAYO  
140 mm





# Muller Vessel Clips and Bulldog Clamps

## Splenor Surgicals

### Closing force



**02-3580**  
Straight  
50g



**02-3581**  
80g



**02-3582**  
Curved  
50g



**02-3583**  
80g



**02-3584**  
Curved tips  
50g



**02-3585**  
80g



**02-3586**  
Angled  
Shaped  
50g



**02-3587**  
80g



**02-3588**  
Muller  
Knee-bent  
50g



**02-3589**  
80g



**02-3590**  
Muller  
Ligature Forceps



Jaw, cross  
serrated  
Jaws profiles  
finally cross-  
serrated.

### Non-traumatic vessel clips, temporary.



**02-3591**  
38 mm  
48 mm



**02-3592**  
38 mm  
48 mm



**02-3593**  
58 mm



**02-3594**  
58 mm



**02-3595 - 02-3601**

- 02-3595 38 mm
- 02-3596 48 mm
- 02-3597 56 mm
- 02-3598 63 mm
- 02-3599 70 mm
- 02-3600 80 mm
- 02-3601 91 mm

















**02-3602**  
DE BAKEY-  
HESS  
Length of  
Jaws 20 mm



# Bulldog Clamps

*Splenor Surgicals*

 <p><b>02-3603</b> 35 mm</p>	 <p><b>02-3604</b> 35 mm</p>	 <p><b>02-3605</b> 45 mm</p>	 <p><b>02-3606</b> 45 mm</p>	 <p><b>DE BAKEY</b> <b>02-3607</b> Length 50 mm Jaws 27 mm</p>	 <p><b>DE BAKEY</b> <b>02-3608</b> Length 48 mm Jaws 27 mm</p>																																																						
 <p><b>02-3609</b> GLOVER Length 57 mm Jaws 35 mm</p>	 <p><b>02-3610</b> DE BAKEY Length 73 mm Jaws 38 mm</p>	 <p><b>02-3611</b> DE BAKEY Length 99 mm Jaws 63 mm</p>	 <p><b>02-3612</b> DE BAKEY Length 95 mm Jaws 54 mm</p>																																																								
 <p><b>DE BAKEY</b> <b>02-3613</b> 80mm <b>02-3614</b> 90mm <b>02-3615</b> 105mm <b>02-3616</b> 124mm</p>	 <p><b>DE BAKEY</b> <b>02-3617</b> 78mm <b>02-3618</b> 86mm <b>02-3619</b> 97mm <b>02-3620</b> 114mm</p>	 <p><b>GLOVER</b> <b>02-3621</b> 68mm <b>02-3622</b> 96mm <b>02-3623</b> 117mm</p>	 <p><b>GLOVER</b> <b>02-3624</b> 65mm <b>02-3625</b> 91mm <b>02-3626</b> 110mm</p>																																																								
<table border="0"> <tr> <td></td> <td>Total length</td> <td>Length of jaw</td> </tr> <tr> <td><b>02-3613</b></td> <td>80mm</td> <td>25mm</td> </tr> <tr> <td><b>02-3614</b></td> <td>90mm</td> <td>35mm</td> </tr> <tr> <td><b>02-3615</b></td> <td>105mm</td> <td>50mm</td> </tr> <tr> <td><b>02-3616</b></td> <td>124mm</td> <td>68mm</td> </tr> </table>		Total length	Length of jaw	<b>02-3613</b>	80mm	25mm	<b>02-3614</b>	90mm	35mm	<b>02-3615</b>	105mm	50mm	<b>02-3616</b>	124mm	68mm	<table border="0"> <tr> <td></td> <td>Total length</td> <td>Length of jaw</td> </tr> <tr> <td><b>02-3617</b></td> <td>78mm</td> <td>25mm</td> </tr> <tr> <td><b>02-3618</b></td> <td>86mm</td> <td>35mm</td> </tr> <tr> <td><b>02-3619</b></td> <td>97mm</td> <td>50mm</td> </tr> <tr> <td><b>02-3620</b></td> <td>114mm</td> <td>68mm</td> </tr> </table>		Total length	Length of jaw	<b>02-3617</b>	78mm	25mm	<b>02-3618</b>	86mm	35mm	<b>02-3619</b>	97mm	50mm	<b>02-3620</b>	114mm	68mm	<table border="0"> <tr> <td></td> <td>Total length</td> <td>Length of jaw</td> </tr> <tr> <td><b>02-3621</b></td> <td>68mm</td> <td>33mm</td> </tr> <tr> <td><b>02-3622</b></td> <td>96mm</td> <td>50mm</td> </tr> <tr> <td><b>02-3623</b></td> <td>117mm</td> <td>69mm</td> </tr> </table>		Total length	Length of jaw	<b>02-3621</b>	68mm	33mm	<b>02-3622</b>	96mm	50mm	<b>02-3623</b>	117mm	69mm	<table border="0"> <tr> <td></td> <td>Total length</td> <td>Length of jaw</td> </tr> <tr> <td><b>02-3624</b></td> <td>65mm</td> <td>33mm</td> </tr> <tr> <td><b>02-3625</b></td> <td>91mm</td> <td>50mm</td> </tr> <tr> <td><b>02-3626</b></td> <td>110mm</td> <td>69mm</td> </tr> </table>		Total length	Length of jaw	<b>02-3624</b>	65mm	33mm	<b>02-3625</b>	91mm	50mm	<b>02-3626</b>	110mm	69mm		
	Total length	Length of jaw																																																									
<b>02-3613</b>	80mm	25mm																																																									
<b>02-3614</b>	90mm	35mm																																																									
<b>02-3615</b>	105mm	50mm																																																									
<b>02-3616</b>	124mm	68mm																																																									
	Total length	Length of jaw																																																									
<b>02-3617</b>	78mm	25mm																																																									
<b>02-3618</b>	86mm	35mm																																																									
<b>02-3619</b>	97mm	50mm																																																									
<b>02-3620</b>	114mm	68mm																																																									
	Total length	Length of jaw																																																									
<b>02-3621</b>	68mm	33mm																																																									
<b>02-3622</b>	96mm	50mm																																																									
<b>02-3623</b>	117mm	69mm																																																									
	Total length	Length of jaw																																																									
<b>02-3624</b>	65mm	33mm																																																									
<b>02-3625</b>	91mm	50mm																																																									
<b>02-3626</b>	110mm	69mm																																																									

# Delicate Haemostatic Forceps



**02-3627**  
CARREL  
85 mm



**02-3628 - 02-3631**  
BABY-MOSQUITO  
(HARTMANN)  
100 mm



**02-3632 - 02-3635**  
MICRO-HALSTED  
125 mm



**02-3636 - 02-3639**  
HALSTED-MOSQUITO  
125 mm



**02-3640 - 02-3641**  
PROVIDENCE-HOSPITAL  
140 mm



**02-3642 - 02-3643**  
KELLY  
140 mm

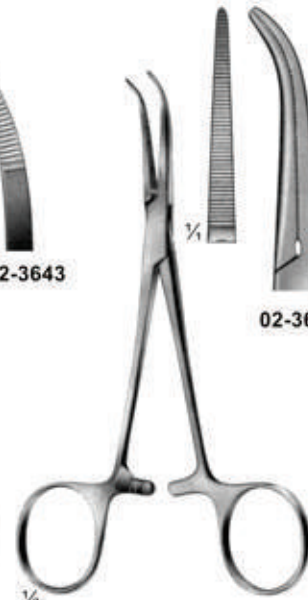

**02-3644 - 02-3645**  
DANDY  
Curved sideways  
140 mm



# Delicate Haemostatic Forceps

*Splenor Surgicals*

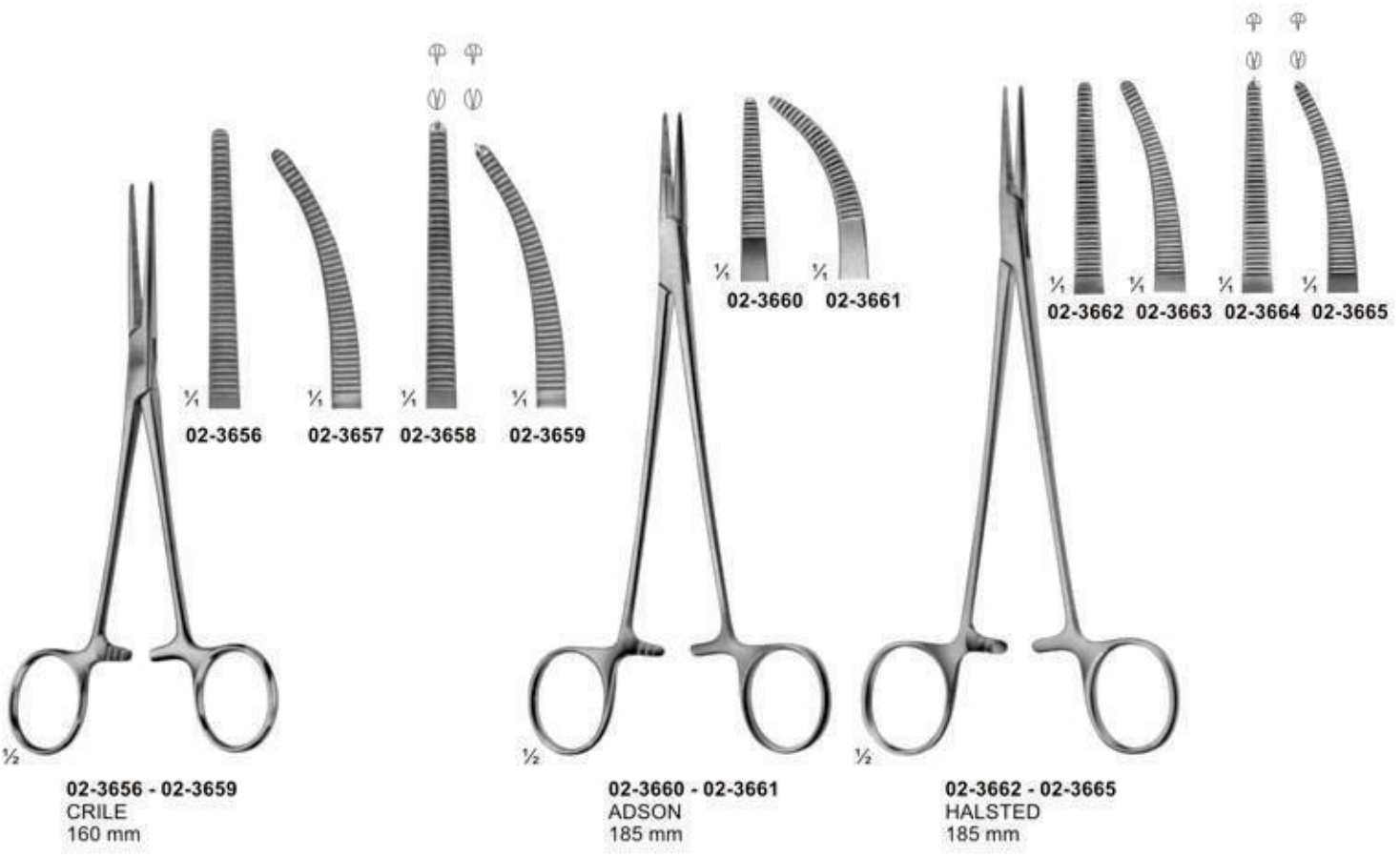
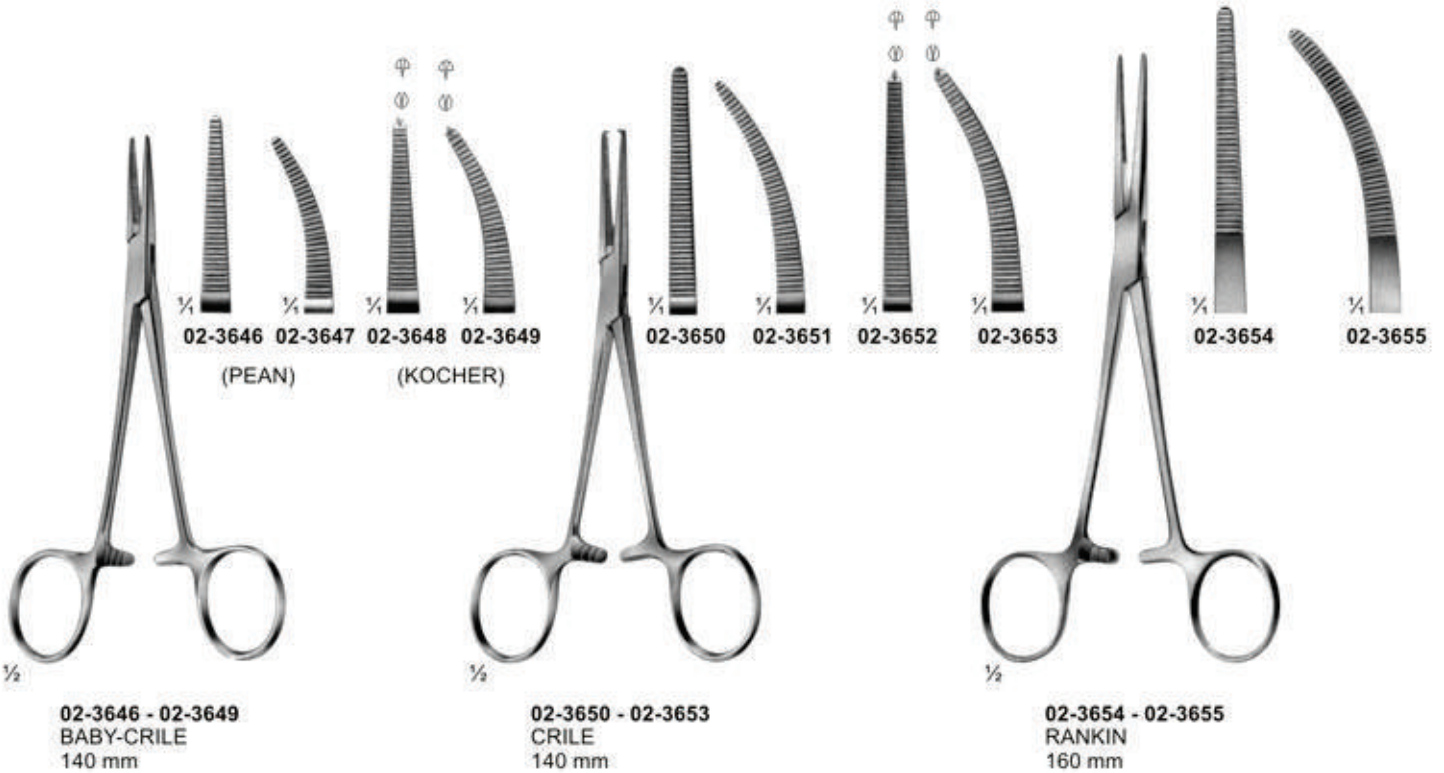



# Delicate Haemostatic Forceps

Splenor Surgicals

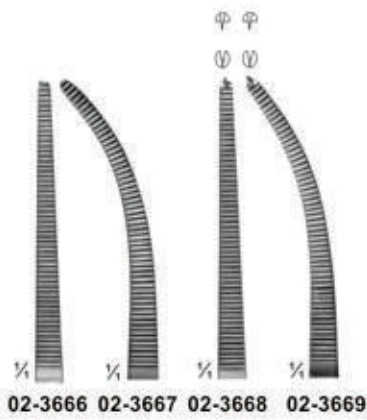

02-3666 02-3667 02-3668 02-3669

02-3666 - 02-3669  
HALSTED-MOSQUITO  
200 mm

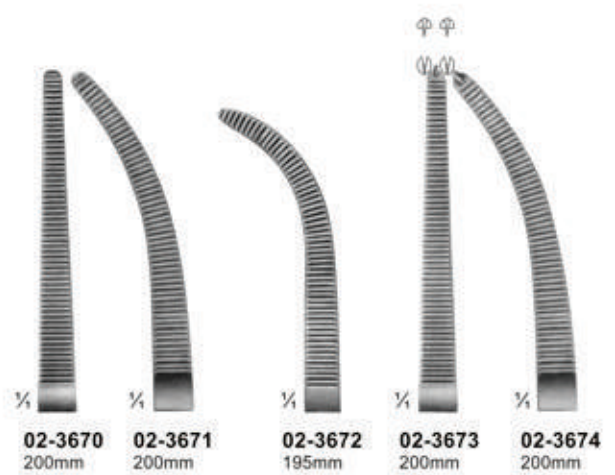

02-3670 02-3671 02-3672 02-3673 02-3674  
200mm 200mm 195mm 200mm 200mm

02-3670 - 02-3674  
HEISS



02-3675 02-3676

02-3675 - 02-3676  
HALSTED  
215 mm

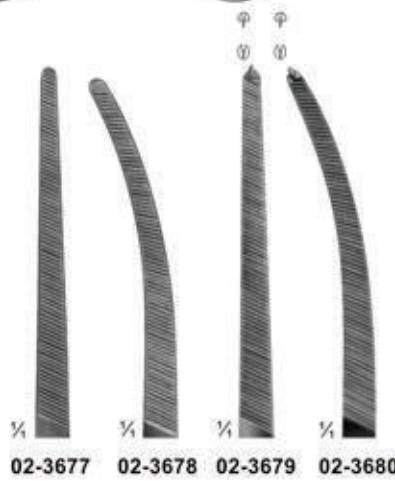
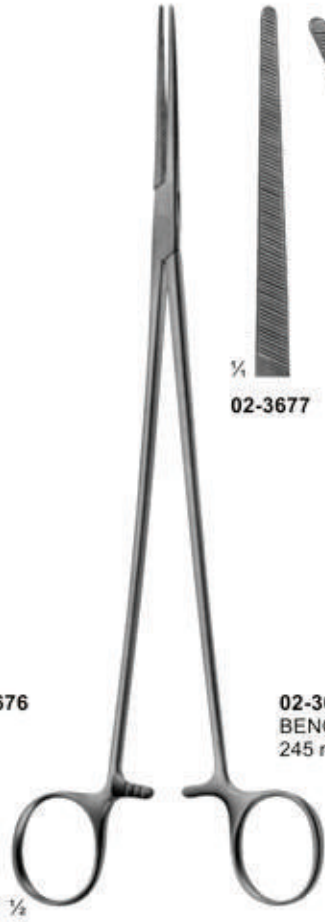

02-3677 02-3678 02-3679 02-3680

02-3677 - 02-3680  
BENGOLEA  
245 mm

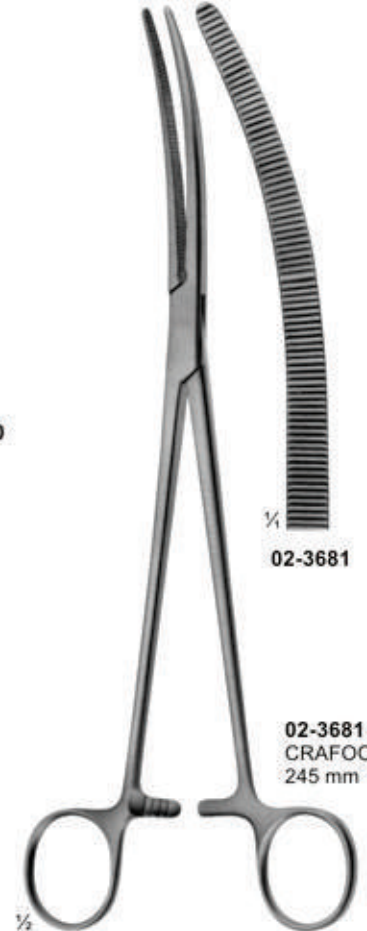

02-3681

02-3681  
CRAFOORD  
245 mm

# Haemostatic Forceps

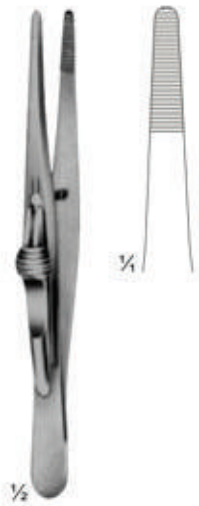

**02-3682**  
FRICKE  
Artery forceps  
130 mm



**02-3683**  
KRONLEIN  
130 mm



**02-3684**  
PEAN  
125 mm



**02-3685**  
125 mm



**02-3686**  
140 mm

**02-3685 - 02-3686**  
PEAN



**02-3687**  
PEAN  
125mm



**02-3688**  
165 mm

**02-3689**  
185 mm

**02-3688 - 02-3689**  
PEAN



# Haemostatic Forceps

*Splenor Surgicals*

**02-3690 - 02-3693**  
PEAN  
Slender type

02-3690	02-3691	02-3692	02-3693
130 mm	140 mm	130 mm	140 mm

**02-3694 - 02-3702**  
SPENCER-WELLS

02-3695	02-3696	02-3697	02-3698	02-3699	02-3700	02-3701	02-3702
130 mm	150 mm	175 mm	200 mm	130 mm	150 mm	175 mm	200 mm

**02-3703 - 02-3712**  
ROCHESTER-PEAN

02-3703	02-3704	02-3705	02-3706	02-3707	02-3708	02-3709	02-3710	02-3711	02-3712
160 mm	185 mm	200 mm	225 mm	240 mm	160 mm	185 mm	200 mm	225 mm	240 mm



# Haemostatic Forceps

*Splenor Surgicals*



02-3713 - 02-3718  
PEAN

02-3713  
240 mm

02-3714  
260 mm

02-3715  
280 mm

02-3716  
240 mm

02-3717  
260 mm

02-3718  
280 mm



02-3719  
KOCHER  
Strong Pattern  
145 mm

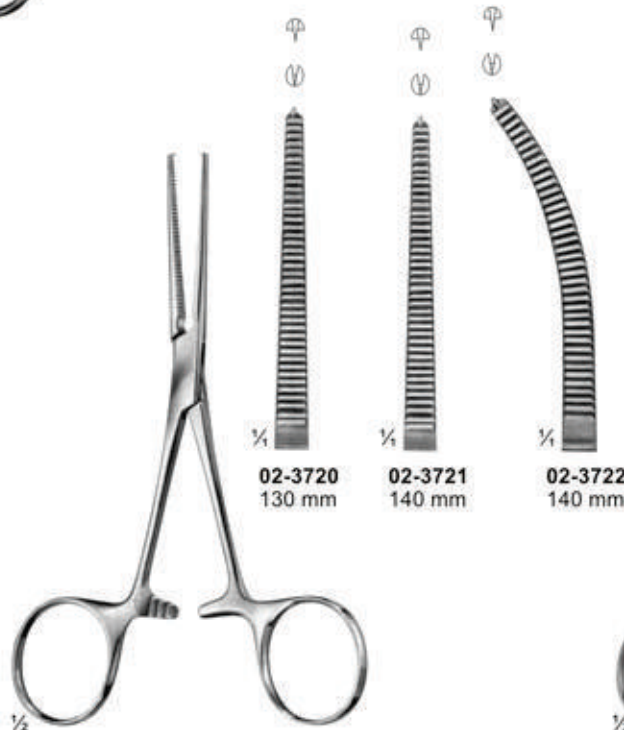

02-3720  
130 mm

02-3721  
140 mm

02-3722  
140 mm



02-3723

02-3724

02-3723 - 02-3724  
ROCHESTER-OCHSNER  
140 mm





# Haemostatic Forceps

Splenor Surgicals

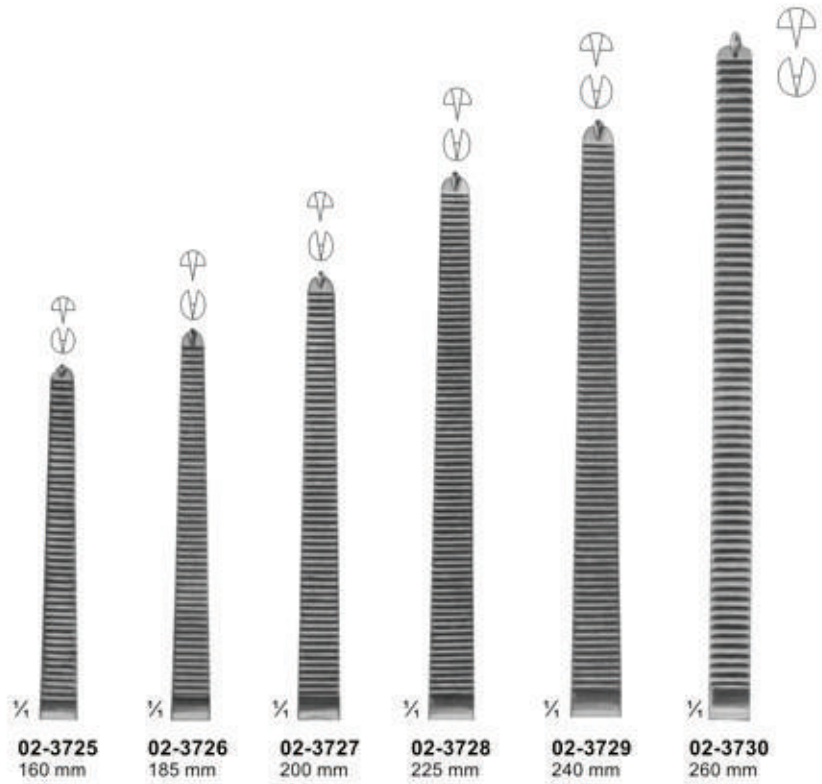

02-3725 - 02-3736  
KOCHER-OCHSNER

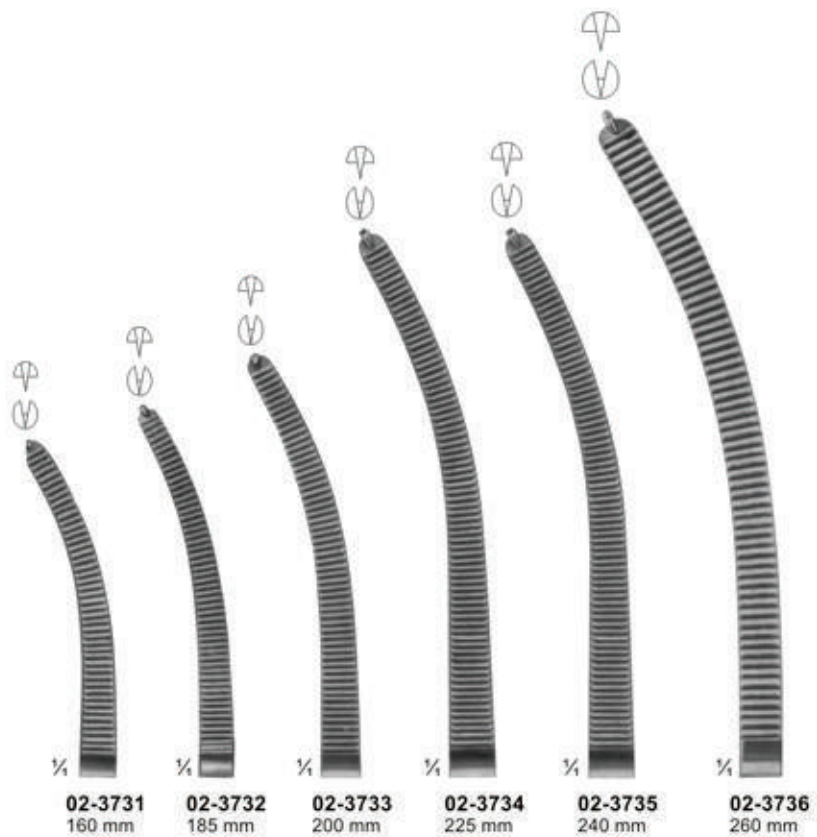

# Haemostatic Forceps, Special Pattern, Tonsil Forceps

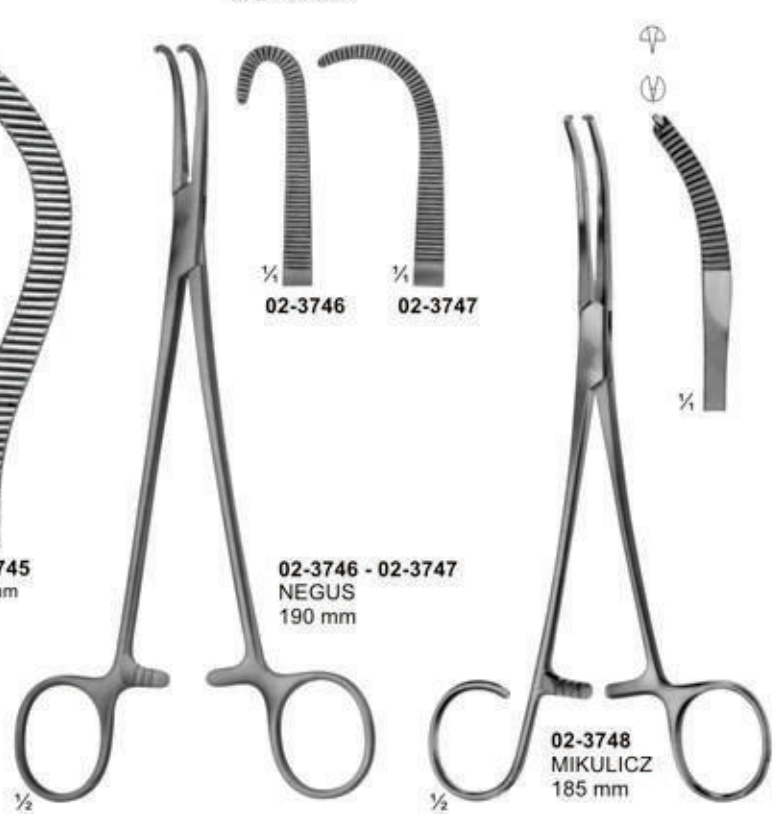
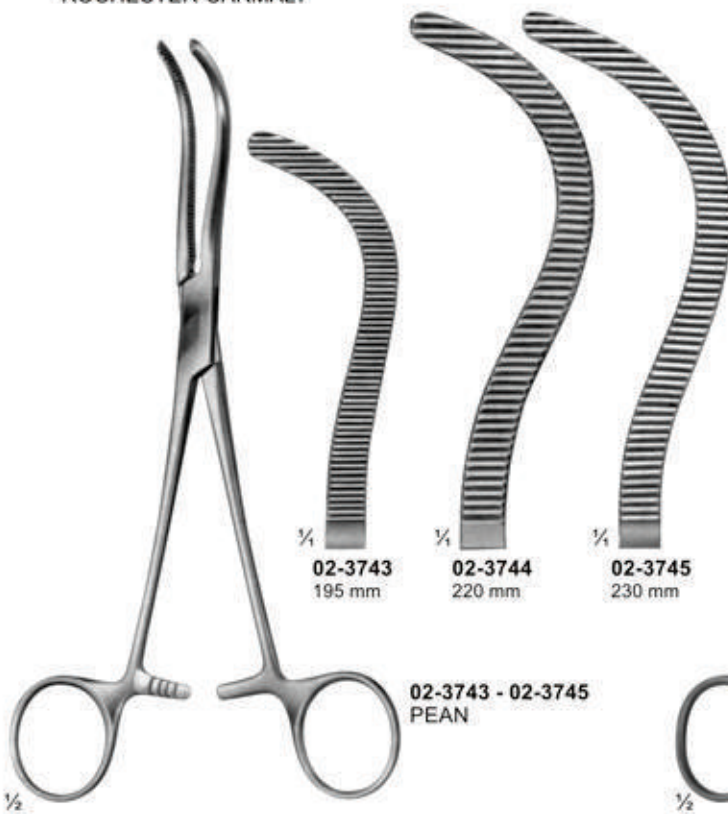
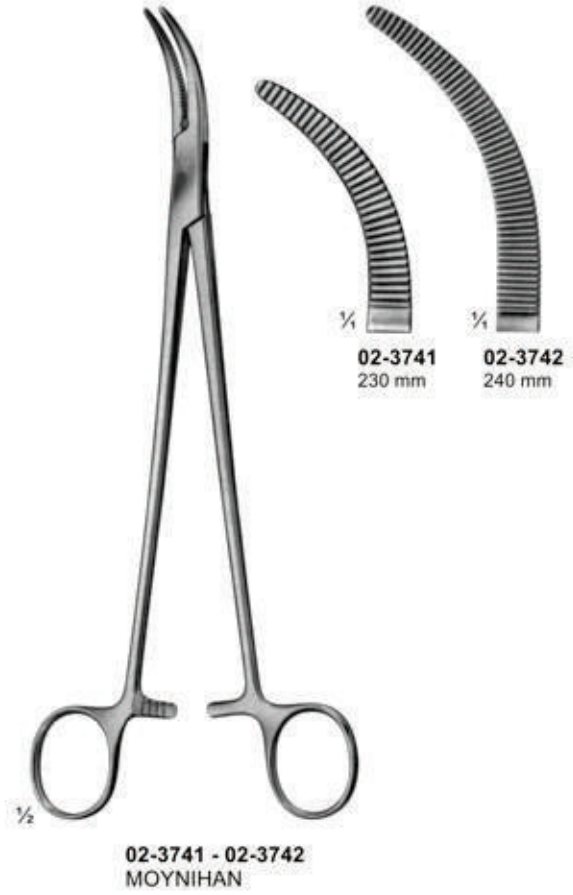

# Dissecting- and Ligature Forceps



**02-3749**  
MICRO-ADSON  
140 mm



**02-3750**  
BABY-OVERHOLT  
135 mm



**02-3751 - 02-3752**  
BABY-MIXTER

**02-3751**  
140 mm

**02-3752**  
180 mm



**02-3753 - 02-3754**  
BABY-ADSON

**02-3753**  
140 mm

**02-3754**  
180 mm



**02-3755**  
NISSEN

**02-3755**  
185 mm



**02-3756 - 02-3757**  
YASARGIL  
195 mm

**02-3756**

**02-3757**



**02-3758**  
OVERHOLT-MIXTER

**02-3758**  
205 mm



# Dissecting- and Ligature Forceps

*Splenor Surgicals*



1/2  
**02-3759 - 02-3770**  
OVERHOLT-GEISSENDOERFER

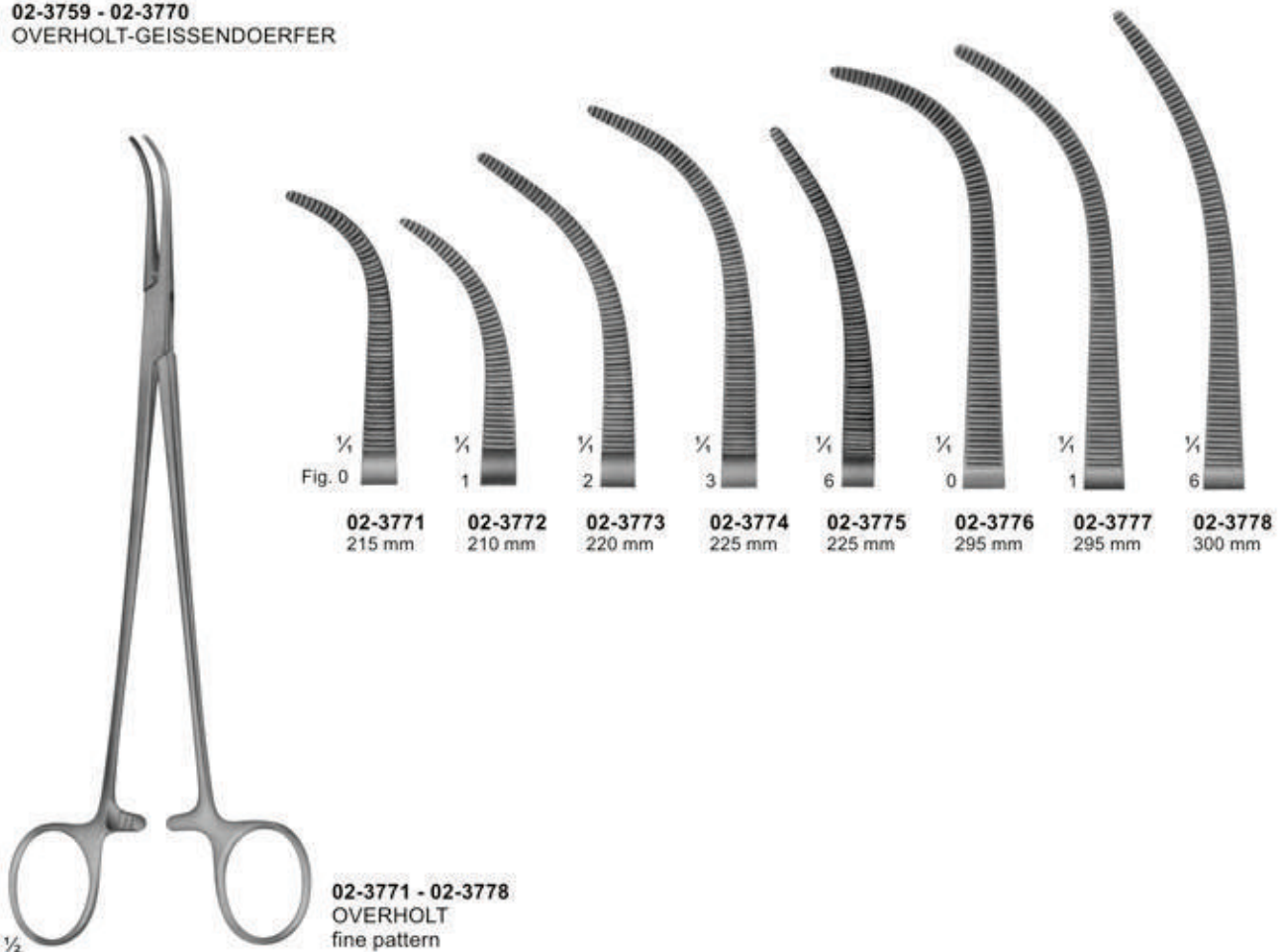
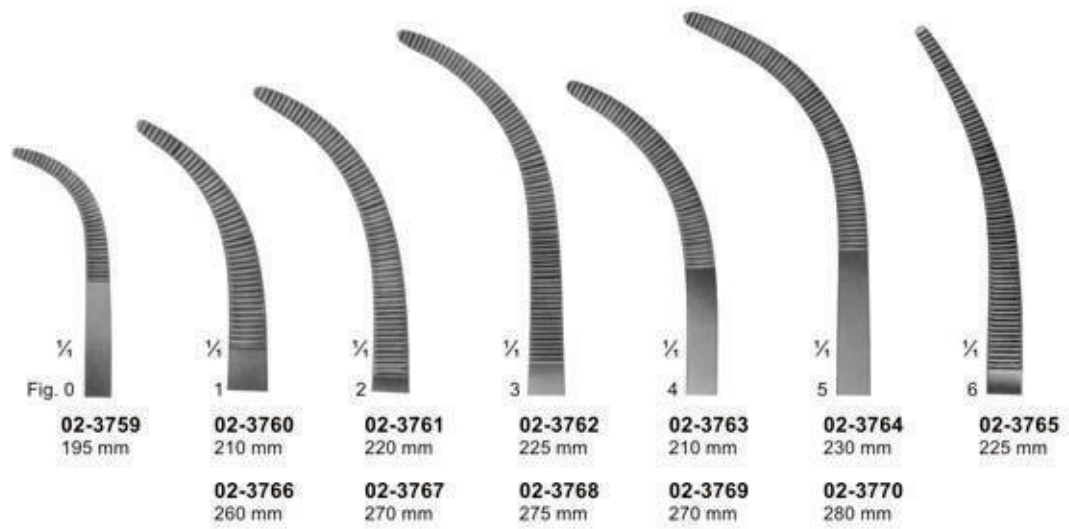

1/2  
**02-3771 - 02-3778**  
OVERHOLT  
fine pattern



# Dissecting- and Ligature Forceps

*Splenor Surgicals*



1/2  
**02-3779**  
MIXTER-O'SHAUGHNESSY  
190 mm



1/2  
**02-3780**  
HEISS  
195 mm



1/2  
**02-3781 - 02-3785**  
RUMEL  
240 mm

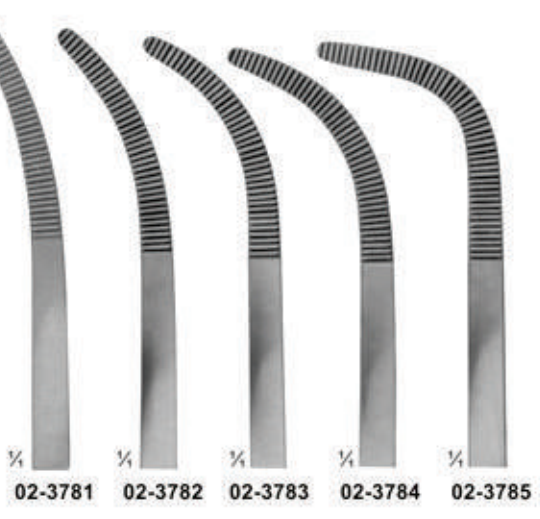

1/4 02-3781 1/4 02-3782 1/4 02-3783 1/4 02-3784 1/4 02-3785

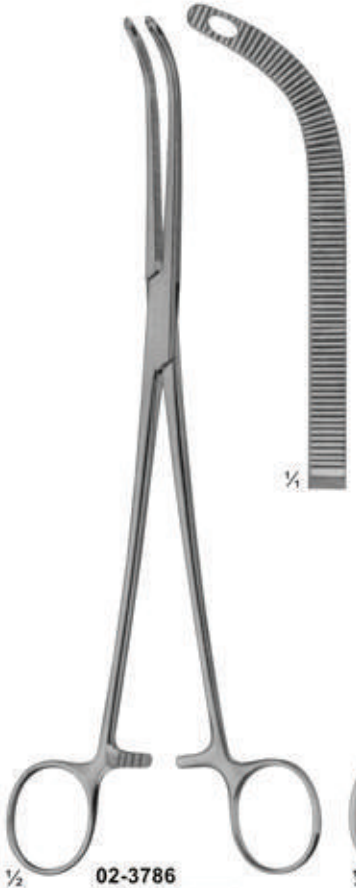

1/2  
**02-3786**  
FINOCHIETTO  
245 mm



1/2  
**02-3787**  
MIXTER  
230 mm



1/2  
**02-3788**  
LAWRENCE  
270 mm

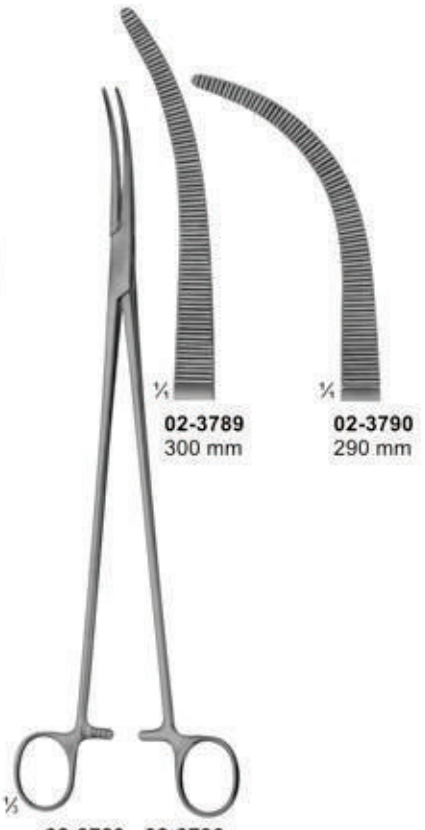

1/2  
**02-3789 - 02-3790**  
ZENKER  
300 mm 290 mm



# Dissecting- and Ligature Forceps

*Splenor Surgicals*





# Peritoneum Forceps

Splenor Surgicals



**02-3799**  
BABY-MIKULICZ  
140 mm



**02-3800**  
MIKULICZ  
185 mm

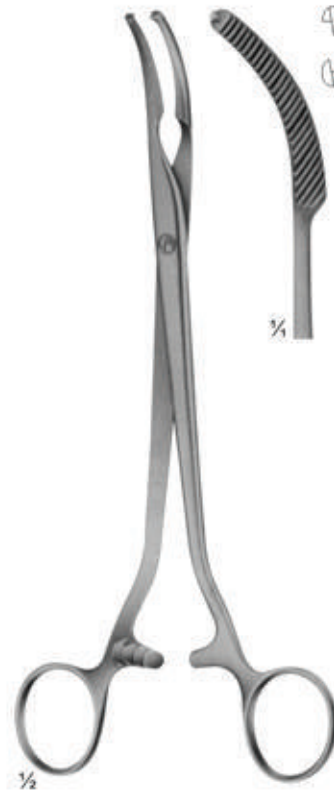

**02-3801**  
MIKULICZ  
205 mm



**02-3802**  
MIKULICZ  
200 mm



**02-3803**  
MIKULICZ  
205 mm



**02-3804**  
MIKULICZ  
185 mm



**02-3805 - 02-3806**  
FAURE  
205 mm



# Hysterectomy and Haemostatic Forceps

*Splenor Surgicals*

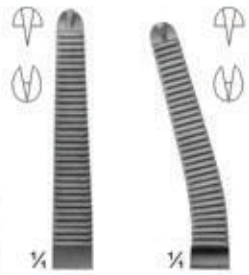

**02-3807**  
210 mm

**02-3808**  
205 mm

**02-3807 - 02-3808**  
PHANEUF



**02-3809**  
205 mm

**02-3810**  
245 mm

**02-3809 - 02-3810**  
HEANEY modif.



**02-3811**  
195 mm

**02-3811**  
HEANEY



**02-3812**  
235 mm

**02-3812**  
WERTHEIM



**02-3813**  
235 mm

**02-3813**  
WERTHEIM



**02-3814**  
245 mm

**02-3814**  
WERTHEIM





# Atraumata Hysterectomy Forceps and Vaginal Clamps ATRAUMATA

*Splenor Surgicals*



¼ **02-3815**  
225 mm



¼ **02-3816**  
220 mm



¼ **02-3817**  
215 mm



¼ **02-3818**  
205 mm



¼ **02-3819**  
250 mm



¼ **02-3820**  
245 mm



¼ **02-3821**  
240 mm



¼ **02-3822**  
220 mm



# Hysterectomy Forceps and Vaginal Clamps and Compression Forceps ATRAUMATA

*Splenor Surgicals*



**02-3823**  
WERTHEIM  
Hysterectomy Forceps  
255 mm



**02-3824**  
WERTHEIM  
Parametrium Clamp  
260 mm



**02-3825 - 02-3827**  
DICK

**02-3825** 255 mm  
**02-3826** 265 mm  
**02-3827** 275 mm



# Clamps and Compression Forceps

*Splenor Surgicals*

## ATRAUMATA



**02-3828**  
WERTHEIM  
250 mm



**02-3829**  
WERTHEIM-CULLEN  
215 mm



**02-3830**  
60 mm

**02-3831**  
80 mm



**02-3830 - 02-3831**  
230 mm

# Section - 02

  
*Splenor Surgicals*



**Pages 23-114**

- ★ Scissors
- ★ Forceps, Clamps
- ★ Needle Holders,  
Micro Needle Holders
- ★ Suture Instruments,  
Needles, Probes, Applicators,  
Pocket Instruments Set.



# Micro Scissors, "Spring Type" Flat Handles *Splenor Surgicals*



**02-3001 - 02-3003**  
VANNAS  
Size: 85 mm



**02-3004 - 02-3005**  
CASTROVIEJO  
Size: 95 mm

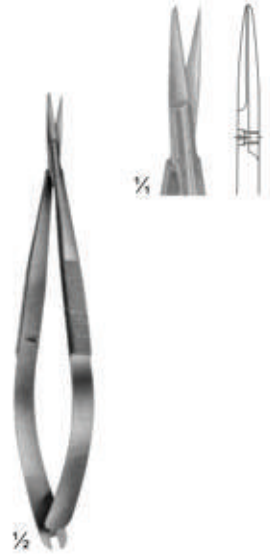

**02-3006**  
NOYES  
Size: 125 mm

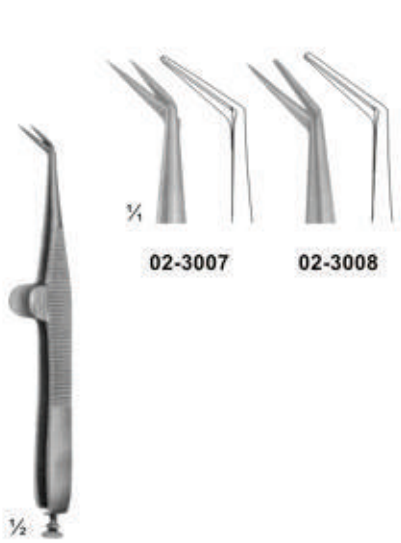

**02-3007 - 02-3008**  
WECKER  
Eye Scissor  
Size: 110 mm

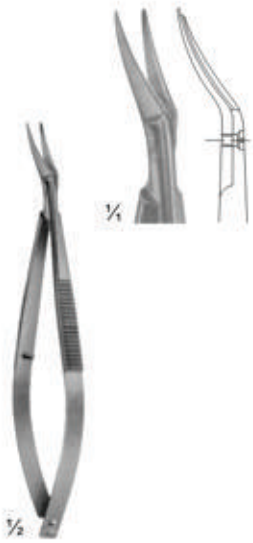

**02-3009**  
CASTROVIEJO  
Eye Scissor  
Size: 115 mm

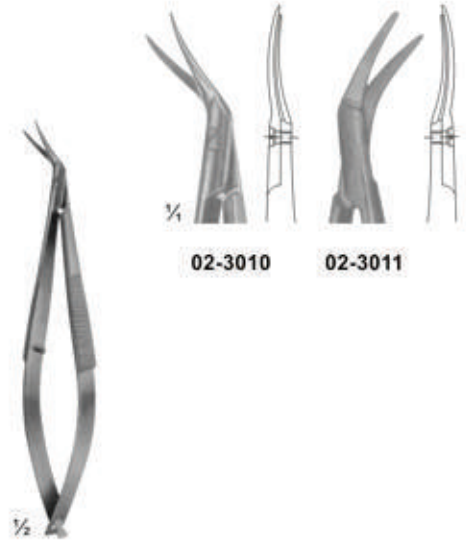

**02-3010 - 02-3011**  
CASTROVIEJO  
Eye Scissor  
Size: 110 mm



# Micro Scissors, "Spring Type" Flat Handles and Cross-Serration

*Splenor Surgicals*

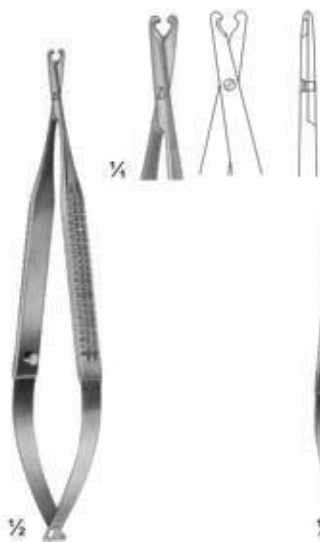

**02-3012**  
BIEMER  
Vein Scissor  
Size: 130 mm

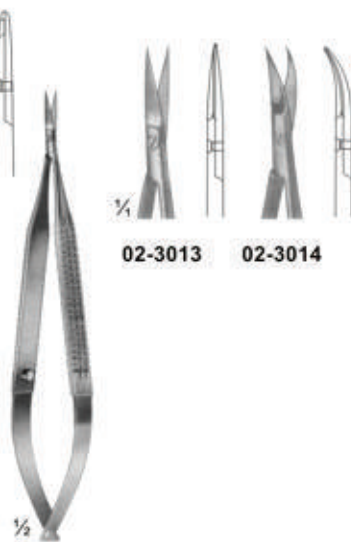

**02-3013 - 02-3014**  
Size: 120 mm



**02-3015 - 02-3016**  
Size: 160 mm



**02-3016**



**02-3017 - 02-3018**  
VANNAS  
Size: 160 mm



**02-3017**



**02-3018**



**02-3019**  
CASPAR  
Micro Scissor Curved



**02-3020 - 02-3022**  
Micro Dissecting Scissor  
Size: 145 mm



**02-3020**



**02-3021**



**02-3022**



# Micro Scissors, "Spring Type" Bayonet Shape



**02-3023**  
YASARGIL  
Size: 245 mm



**02-3024**  
45°  
Nagel



**02-3025**  
45°



**02-3026**  
Laterally Angled  
Size: 190 mm



**02-3024 - 02-3025**  
Laterally Angled  
Size: 200 mm



**02-3027**

**02-3028**



**02-3027 - 02-3028**  
YASARGIL  
Size: 225 mm



# Delicate Scissors

*Splenor Surgicals*

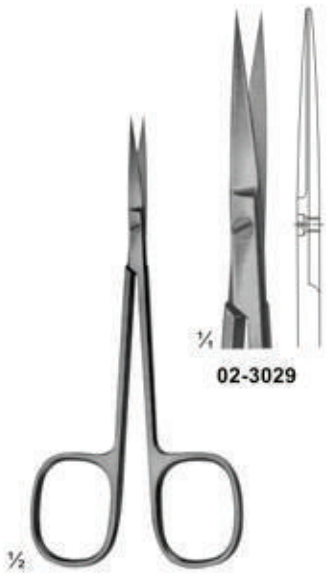

02-3029



02-3030

02-3029-02-3030  
Size: 120 mm

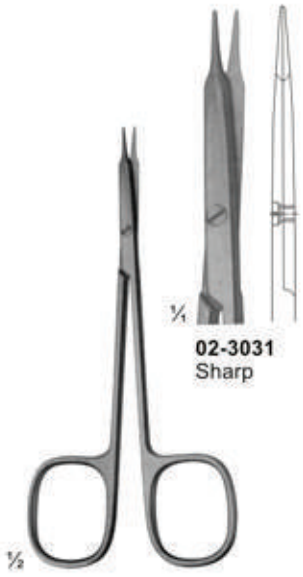

02-3031  
Sharp



02-3032  
Sharp

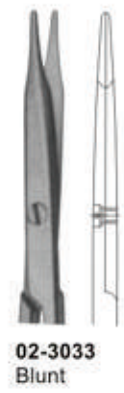

02-3033  
Blunt



02-3034  
Blunt

02-3031 - 02-3034  
STEVENS  
Dissecting Scissors  
Size: 115 mm

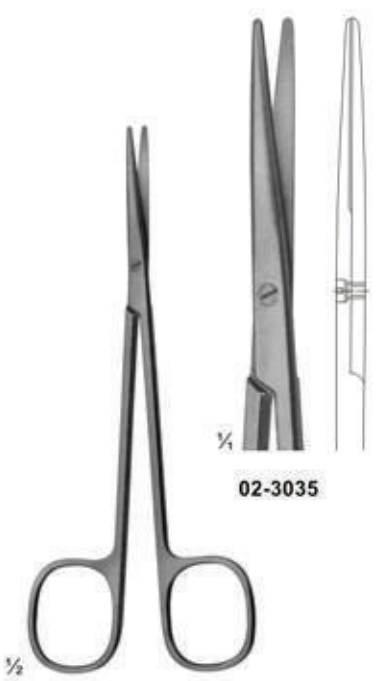

02-3035



02-3036

02-3035 - 02-3036  
METZENBAUM  
Dissecting Scissors  
Size: 145 mm

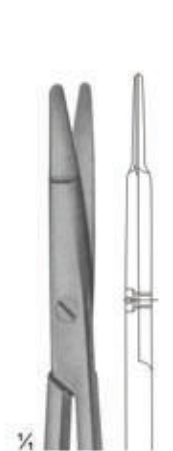
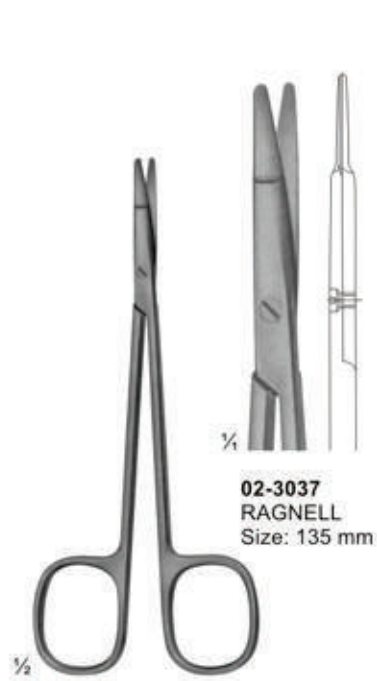

02-3037  
RAGNELL  
Size: 135 mm

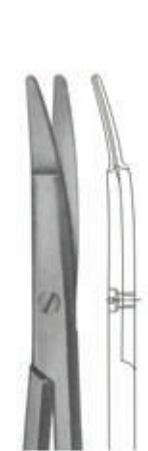

02-3038  
RAGNELL  
Size: 135 mm



02-3039  
Size: 150 mm

02-3037 - 02-3039  
Special flat points for  
dissecting and  
undermining the skin





# Delicate Scissors

*Splenor Surgicals*



02-3040

02-3041

02-3040 - 02-3041  
Size: 90 mm



02-3042

02-3043

02-3042 - 02-3043  
Size: 95 mm



02-3044

02-3045

02-3044 - 02-3045  
Size: 105 mm



02-3046

02-3047

02-3046 - 02-3047  
Size: 120 mm



02-3048

02-3049

02-3048 - 02-3049  
Size: 115 mm



# Delicate Scissors

*Splenor Surgicals*



02-3050 - 02-3052  
Size: 120 mm

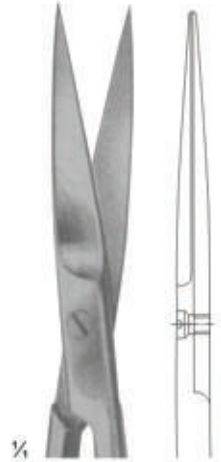

02-3050

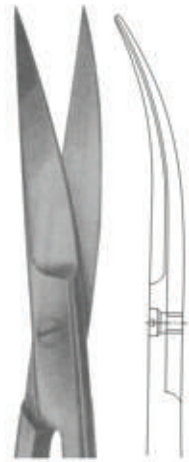

02-3051



02-3052



02-3053 - 02-3056  
Size: 130 mm

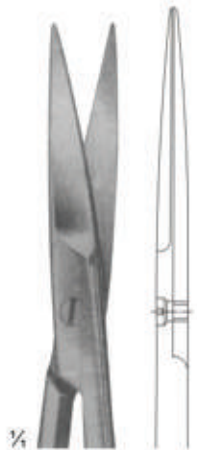

02-3053



02-3054



02-3055



02-3056



# Delicate Scissors

*Splenor Surgicals*

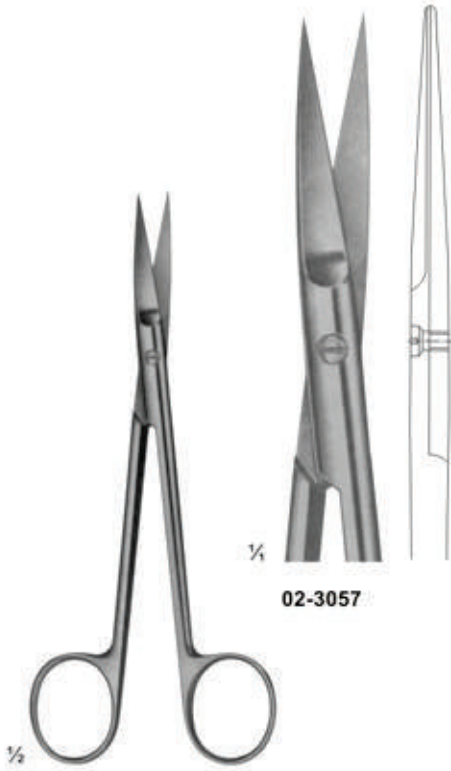

02-3057

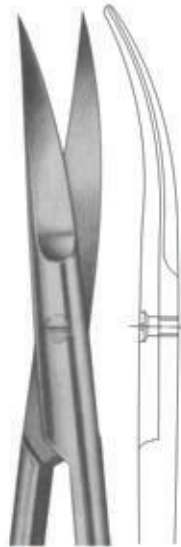

02-3058

02-3057 - 02-3058  
JOSEPH  
Size: 150 mm

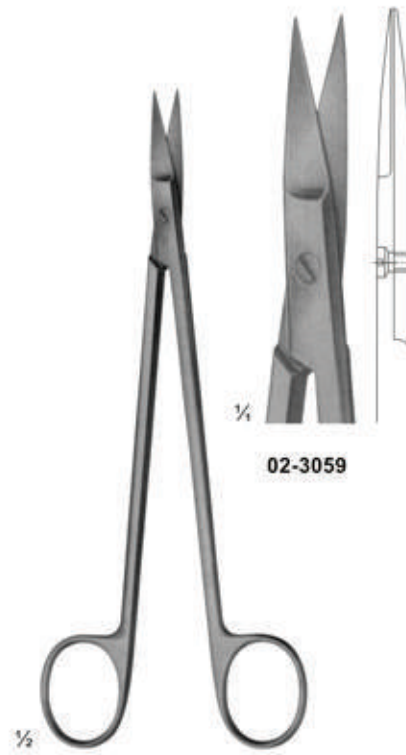

02-3059

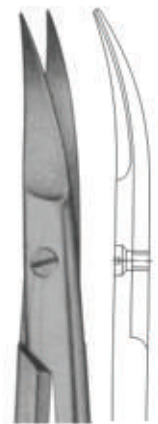

02-3060

02-3059 - 02-3060  
KELLY  
Size: 175 mm



02-3061  
QUINBY  
Size: 130 mm

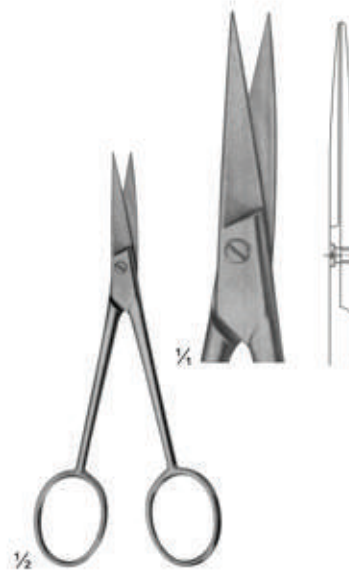

02-3062  
Size: 110 mm



# Surgical Scissors

*Splenor Surgicals*



02-3063 - 02-3071 (Standard Types)  
 02-3063 ( 105 mm )  
 02-3064 ( 115 mm )  
 02-3065 ( 130 mm )  
 02-3066 ( 145 mm )  
 02-3067 ( 150 mm )  
 02-3068 ( 165 mm )  
 02-3069 ( 175 mm )  
 02-3070 ( 185 mm )  
 02-3071 ( 200 mm )



02-3063  
 Size: 105 mm



02-3071  
 Size: 200 mm



02-3072 - 02-3078 (Standard Types)  
 02-3072( 115 mm )  
 02-3073 ( 130 mm )  
 02-3074 ( 145 mm )  
 02-3075 ( 150 mm )  
 02-3076 ( 165 mm )  
 02-3077 ( 175 mm )  
 02-3078( 185 mm )



02-3072  
 Size: 115 mm



02-3078  
 Size: 185 mm



02-3079 - 02-3082  
 Slender Types



02-3079  
 130 mm



02-3080  
 145 mm



02-3081  
 130 mm



02-3082  
 145 mm



02-3083 - 02-3084  
 For Wound Edges  
 1 Blade Serrated



02-3083  
 130 mm



02-3084  
 130 mm



# Surgical Scissors

# Splenor Surgicals

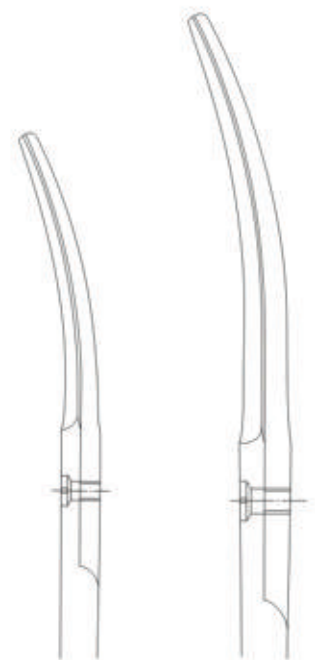
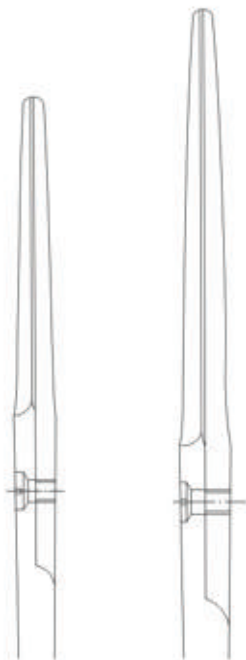

**02-3085 - 02-3089** (Standard Types)  
**02-3085** ( 130 mm )  
**02-3086** ( 145 mm )  
**02-3087** ( 150 mm )  
**02-3088** ( 165 mm )  
**02-3089** ( 175 mm )

**02-3085** Size: 130 mm    **02-3089** Size: 175 mm

**02-3090 - 02-3095** - COOPER  
 Standard Types  
**02-3090** ( 115 mm )  
**02-3091** ( 130 mm )  
**02-3092** ( 145 mm )  
**02-3093** ( 150 mm )  
**02-3094** ( 165 mm )  
**02-3095** ( 175 mm )

**02-3090** Size: 115 mm    **02-3095** Size: 175 mm

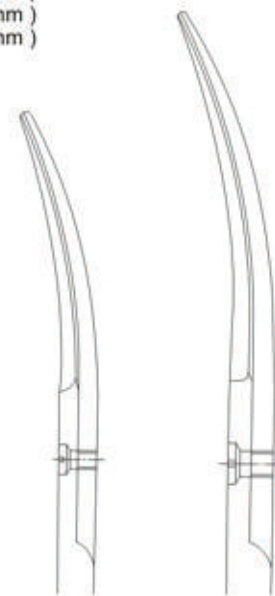
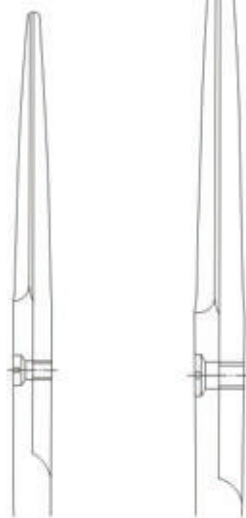

**02-3096 - 02-3102A**  
 Standard Types  
**02-3096** ( 115 mm )    **02-3100A** ( 115 mm )  
**02-3097** ( 130 mm )    **02-3101** ( 130 mm )  
**02-3098** ( 145 mm )    **02-3101A** ( 145 mm )  
**02-3099** ( 150 mm )    **02-3102** ( 150 mm )  
**02-3100** ( 165 mm )    **02-3102A** ( 165 mm )

**02-3096** Size: 115 mm    **02-3100** Size: 165 mm

**02-3100A** Size: 115 mm    **02-3102A** Size: 165 mm

# Surgical Scissors



**02-3103 - 02-3106**  
DEAVER  
With flat lock

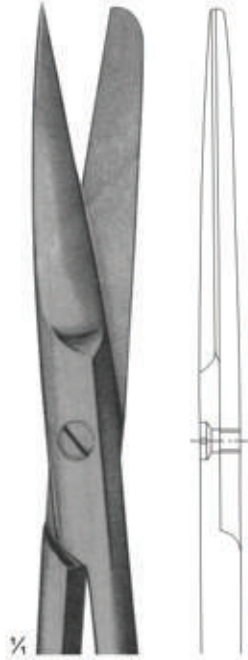

**02-3103**  
Size: 145 mm

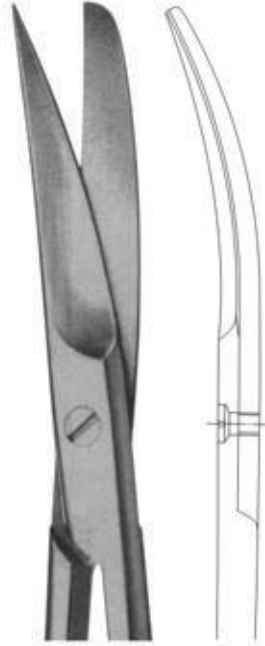

**02-3104**  
Size: 145 mm

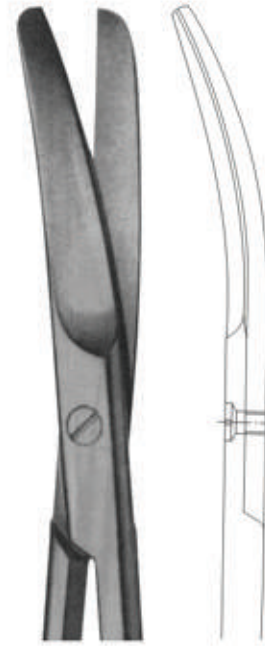

**02-3105**  
Size: 145 mm



**02-3106**  
Size: 145 mm



**02-3107 - 02-3109**  
Incision Scissors



**02-3107**  
Size: 130 mm

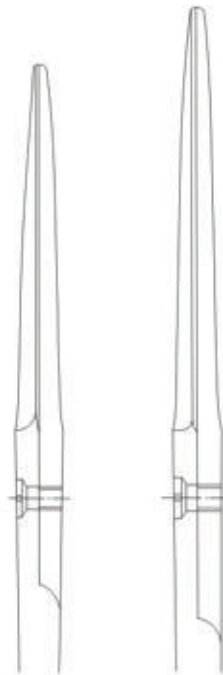

**02-3108**  
Size: 145 mm

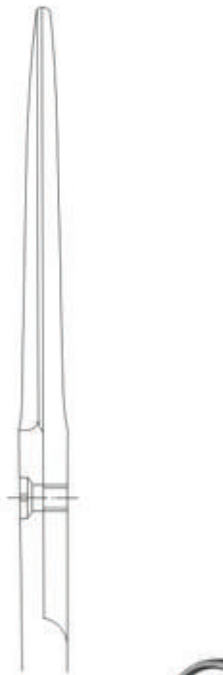

**02-3109**  
Size: 165 mm



**02-3110**  
SYSTRUNK  
Nail Splitting Scissors



**02-3110**  
Size: 130 mm



# Dissecting Scissors

Splenor Surgicals

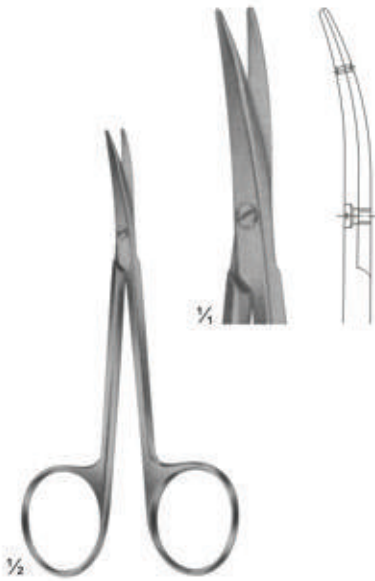

**02-3111**  
**LITTLER**  
Dissecting Scissors  
Tips with eye for suture  
Size: 115 mm

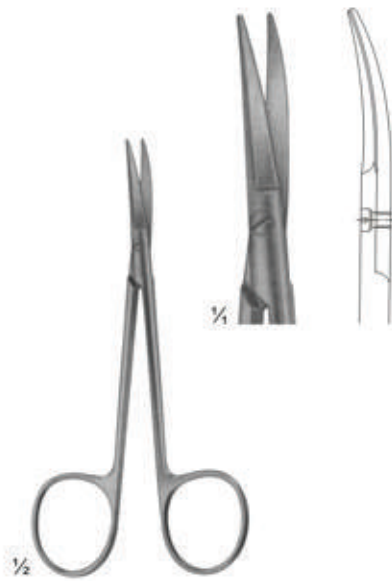

**02-3112**  
**COTTLE**  
Bulldog Scissors  
Size: 115 mm



**02-3113 - 02-3114**  
**STEVENS**  
Vessel and tendon Scissors  
Size: 100 mm

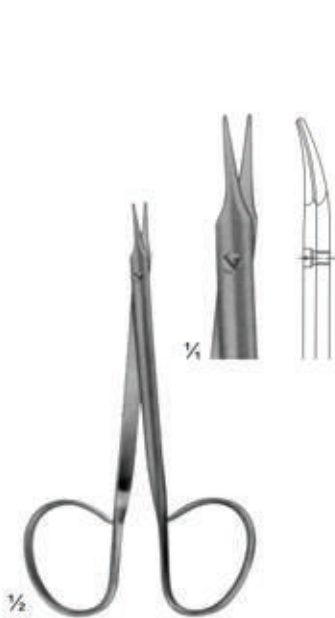

**02-3115**  
**STEVENS**  
Fine Dissecting Scissors  
Size: 110 mm

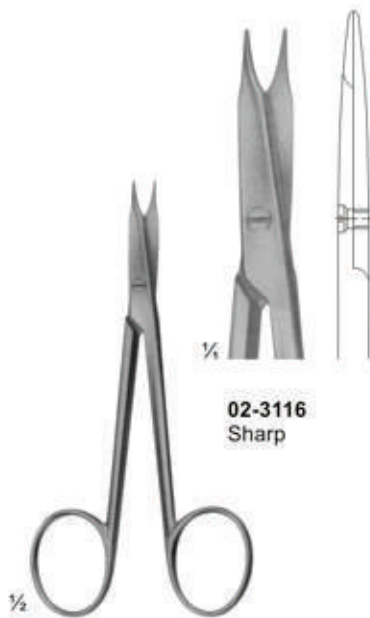

**02-3116 - 02-3119**  
**STEVENS**  
Vessel and tendon Scissors  
Size: 110 mm

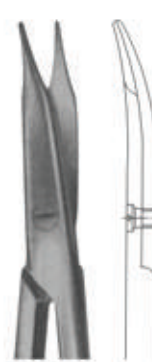

**02-3117**  
Sharp



**02-3118**  
Blunt





**02-3119**  
Blunt

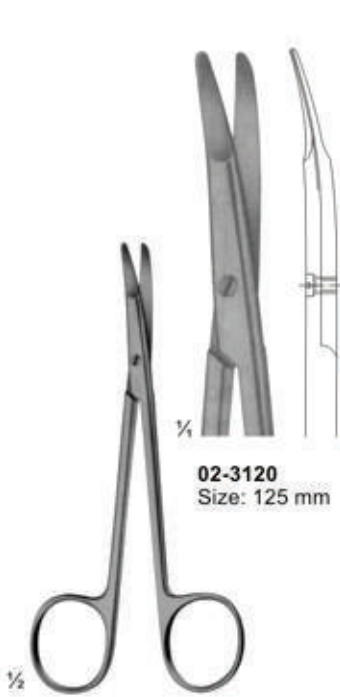
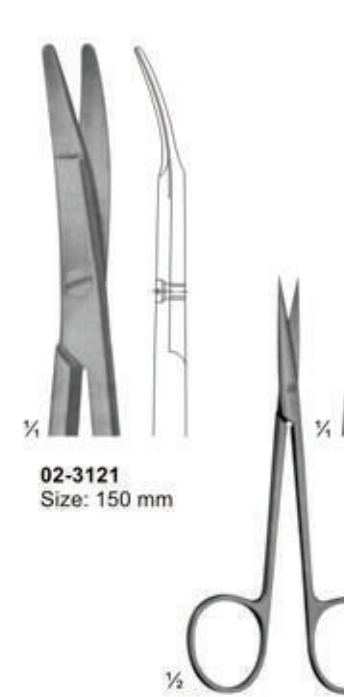
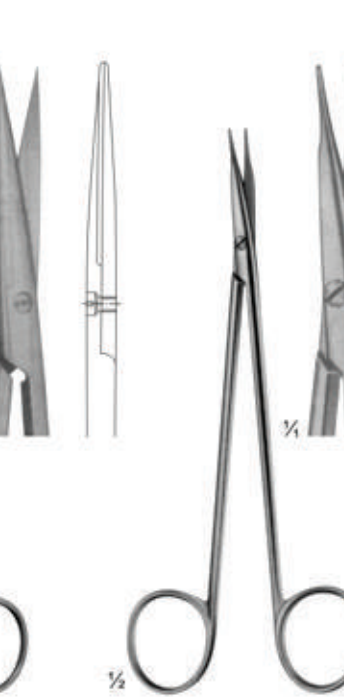
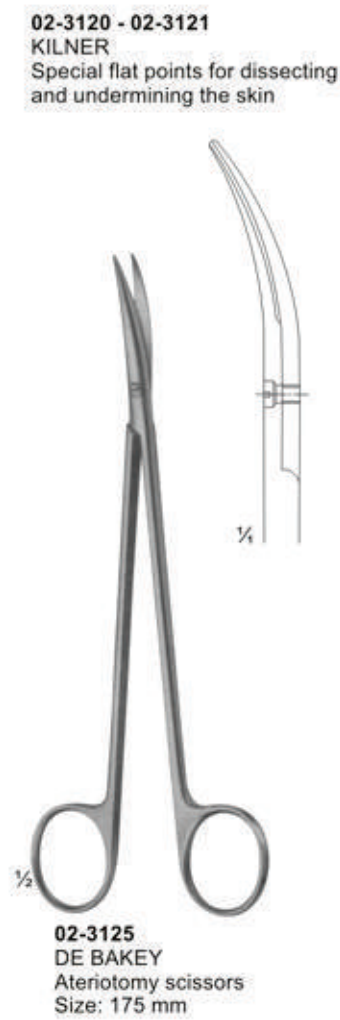

# Dissecting Scissors

*Splenor Surgicals*

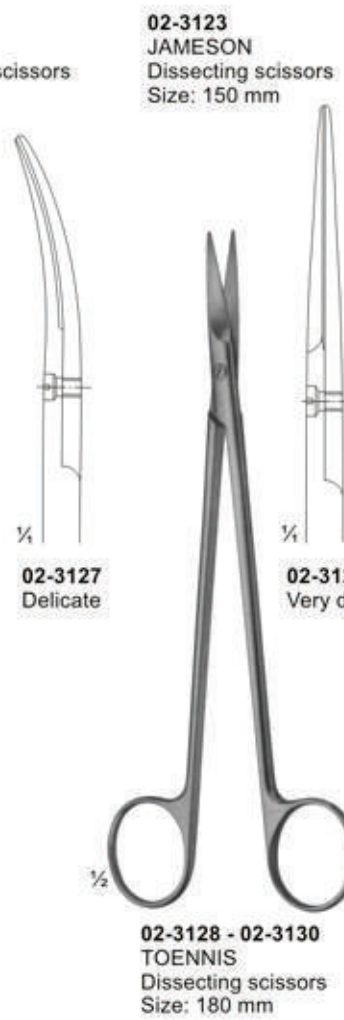
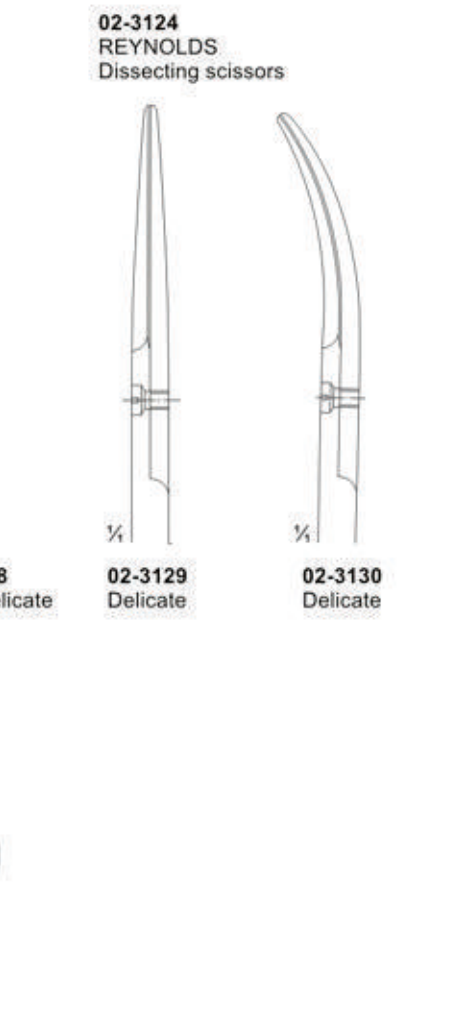
 <p><b>02-3120</b> Size: 125 mm</p> <p><b>02-3121</b> Size: 150 mm</p>	 <p><b>02-3122</b> KILNER Fine dissecting scissors Size: 115 mm</p>	 <p><b>02-3123</b> JAMESON Dissecting scissors Size: 150 mm</p>	 <p><b>02-3124</b> REYNOLDS Dissecting scissors</p> <p>145 mm 175 mm</p>
 <p><b>02-3120 - 02-3121</b> KILNER Special flat points for dissecting and undermining the skin</p> <p><b>02-3125</b> DE BAKEY Ateriotomy scissors Size: 175 mm</p>	 <p><b>02-3126</b> Very delicate</p> <p><b>02-3127</b> Delicate</p> <p><b>02-3126 - 02-3127</b> TOENNIS - ADSON Dissecting scissors Size: 175 mm</p>	 <p><b>02-3128</b> Very delicate</p> <p><b>02-3128 - 02-3130</b> TOENNIS Dissecting scissors Size: 180 mm</p>	 <p><b>02-3129</b> Delicate</p> <p><b>02-3130</b> Delicate</p>





# Dissecting & Surgical Scissors

## Splenor Surgicals

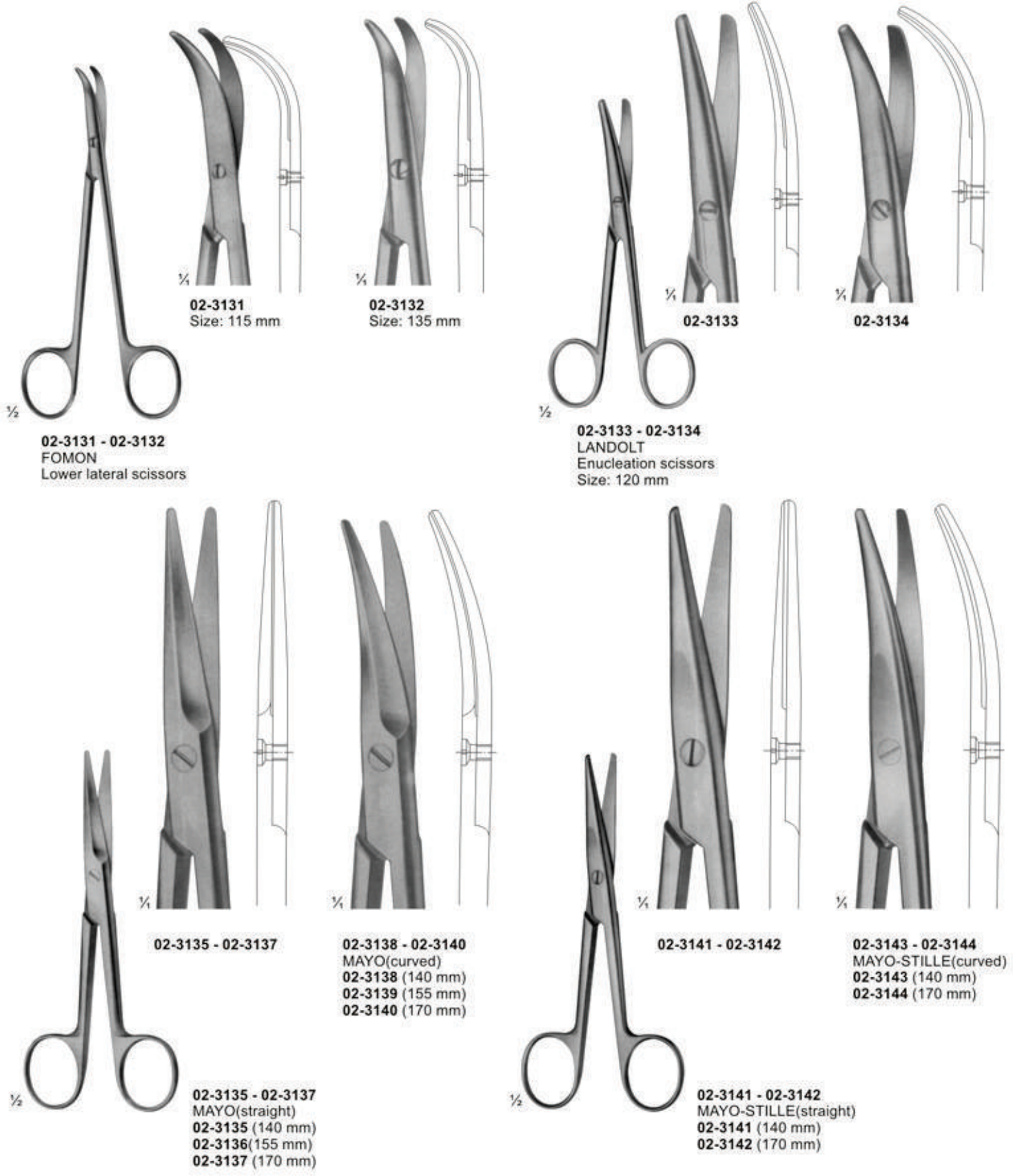

02-3131  
Size: 115 mm

02-3132  
Size: 135 mm

02-3133

02-3134

02-3131 - 02-3132  
FOMON  
Lower lateral scissors

02-3133 - 02-3134  
LANDOLT  
Enucleation scissors  
Size: 120 mm

02-3135 - 02-3137

02-3138 - 02-3140  
MAYO(curved)  
02-3138 (140 mm)  
02-3139 (155 mm)  
02-3140 (170 mm)

02-3141 - 02-3142

02-3143 - 02-3144  
MAYO-STILLE(curved)  
02-3143 (140 mm)  
02-3144 (170 mm)

02-3135 - 02-3137  
MAYO(straight)  
02-3135 (140 mm)  
02-3136(155 mm)  
02-3137 (170 mm)

02-3141 - 02-3142  
MAYO-STILLE(straight)  
02-3141 (140 mm)  
02-3142 (170 mm)

# Dissecting Scissors

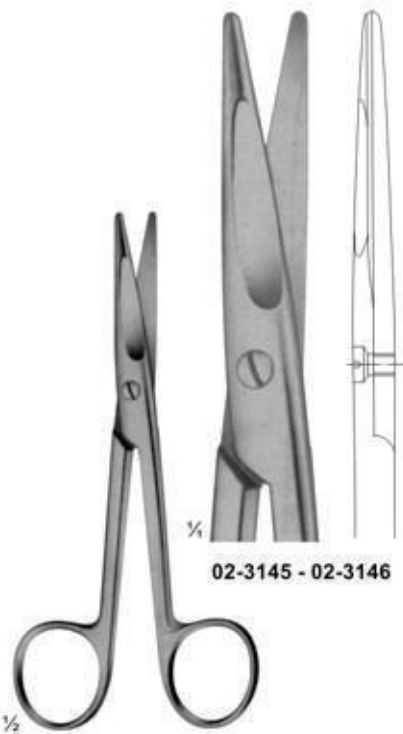

02-3145 - 02-3146

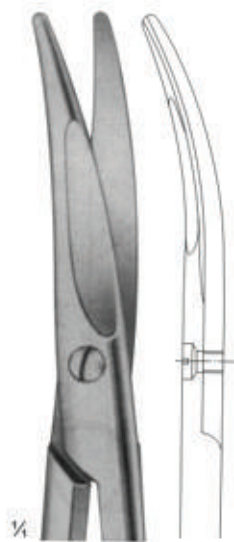

MAYO-STILLE  
02-3147 - 02-3148  
02-3147 (14cm)  
02-3148 (17cm)

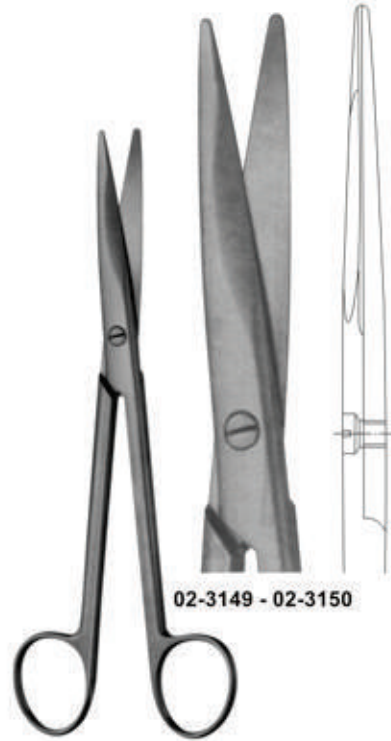

02-3149 - 02-3150



MAYO  
02-3151  
Size: 190 mm  
02-3152  
Size: 215 mm

02-3145 - 02-3146  
MAYO-STILLE  
With chamfered blades  
02-3145 (140 mm)  
02-3146 (170 mm)

MAYO  
With chamfered blades  
02-3149 (190 mm)  
02-3150 (215 mm)



02-3153  
Size: 170 mm

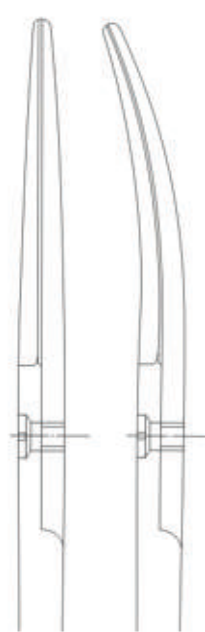

02-3154  
Size: 170 mm

02-3153 - 02-3154  
MAYO-NOBLE (Broad pattern)



02-3155 - 02-3156  
MAYO-HARRINGTON



02-3155  
Size: 230 mm

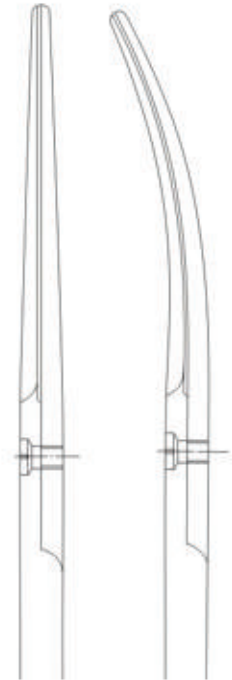

02-3156  
Size: 230 mm



# Dissecting Scissors

Splenor Surgicals

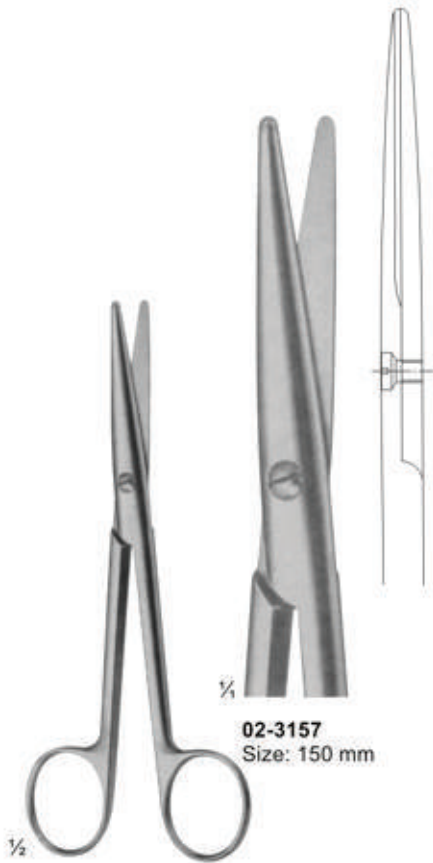

02-3157  
Size: 150 mm

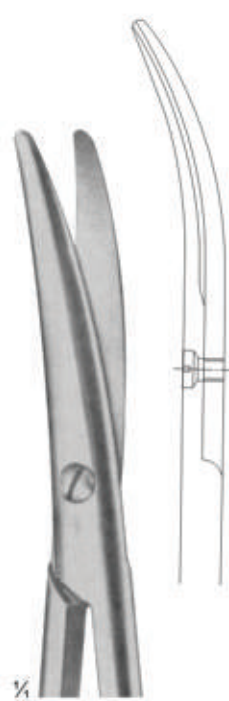

02-3158  
Size: 150 mm

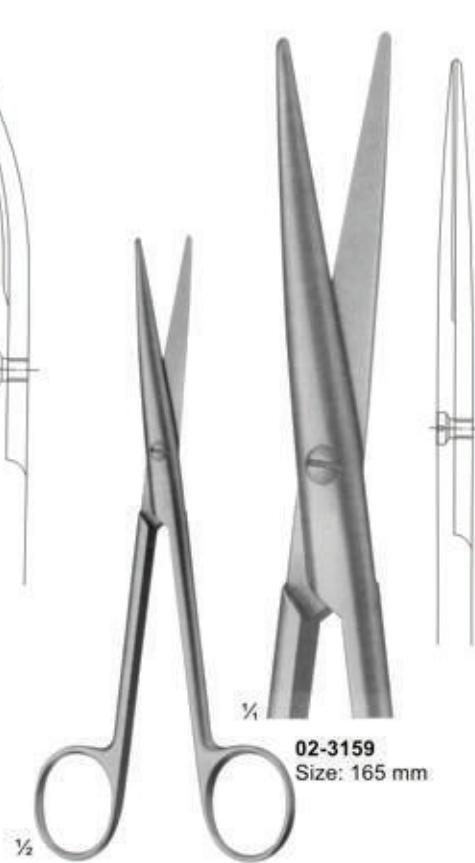

02-3159  
Size: 165 mm



02-3160  
Size: 165 mm

02-3157 - 02-3158  
STILLE

02-3159 - 02-3160  
LEXER  
Narrow

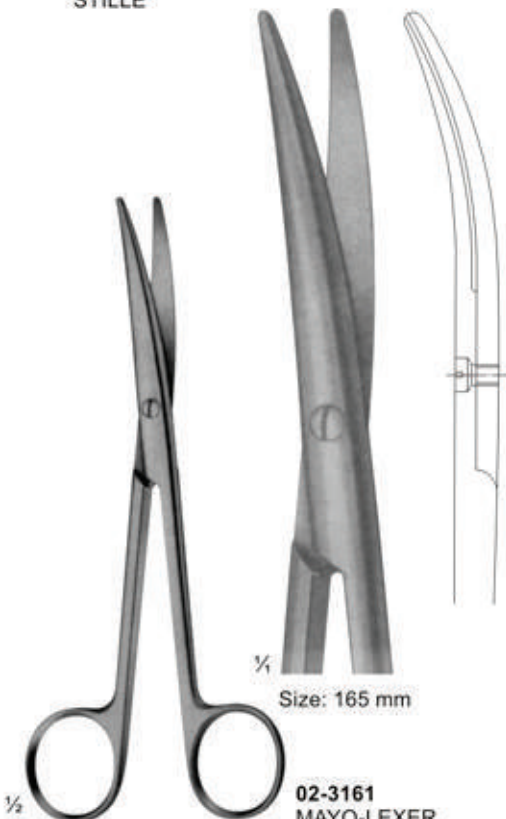

02-3161  
Size: 165 mm

02-3161  
MAYO-LEXER  
Standard

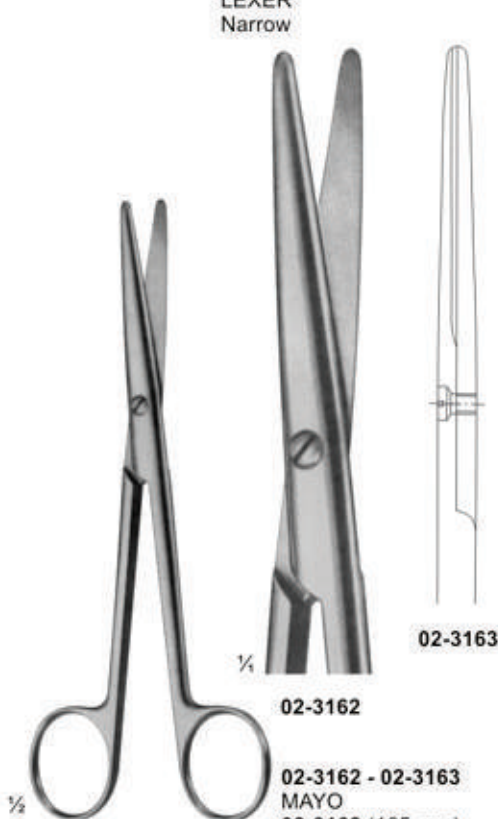

02-3163

02-3162

02-3162 - 02-3163  
MAYO  
02-3162 (165 mm)  
02-3163 (200 mm)



MAYO  
02-3164  
Size: 165 mm

02-3165  
Size: 200 mm  
02-3166  
Size: 210 mm



# Dissecting Scissors

*Splenor Surgicals*

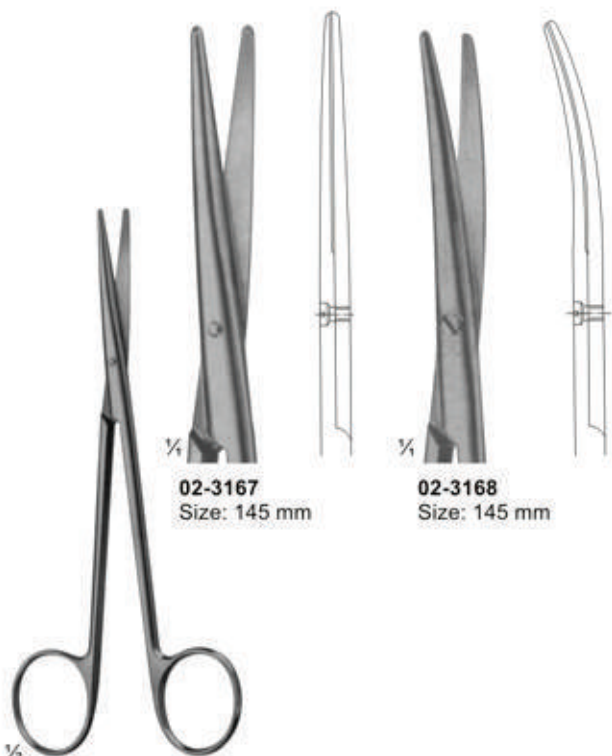

02-3167  
Size: 145 mm

02-3168  
Size: 145 mm

02-3167 - 02-3168  
BABY - METZENBAUM

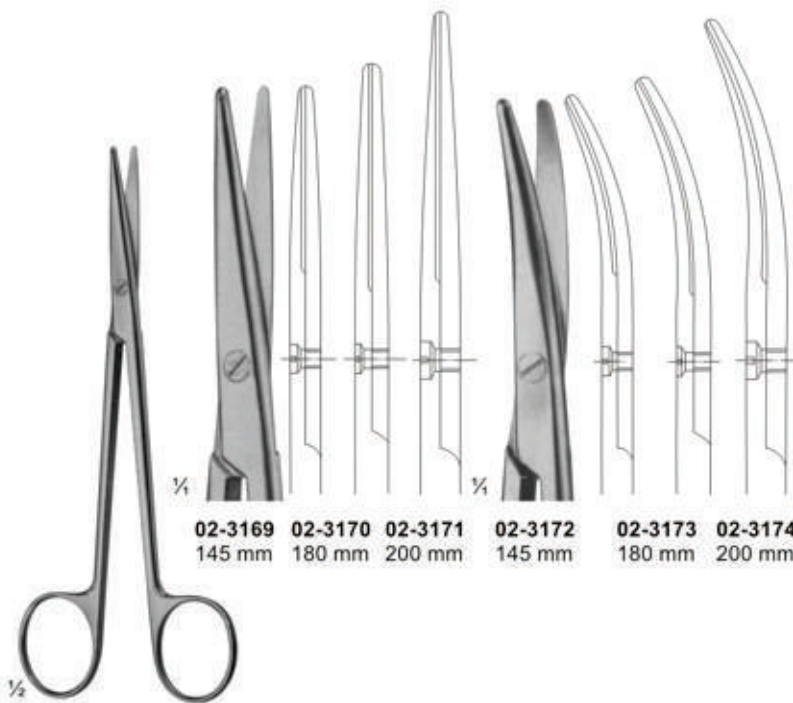

02-3169  
145 mm

02-3170  
180 mm

02-3171  
200 mm

02-3172  
145 mm

02-3173  
180 mm

02-3174  
200 mm

02-3169 - 02-3174  
METZENBAUM



02-3175 - 02-3182  
NELSON  
METZENBAUM

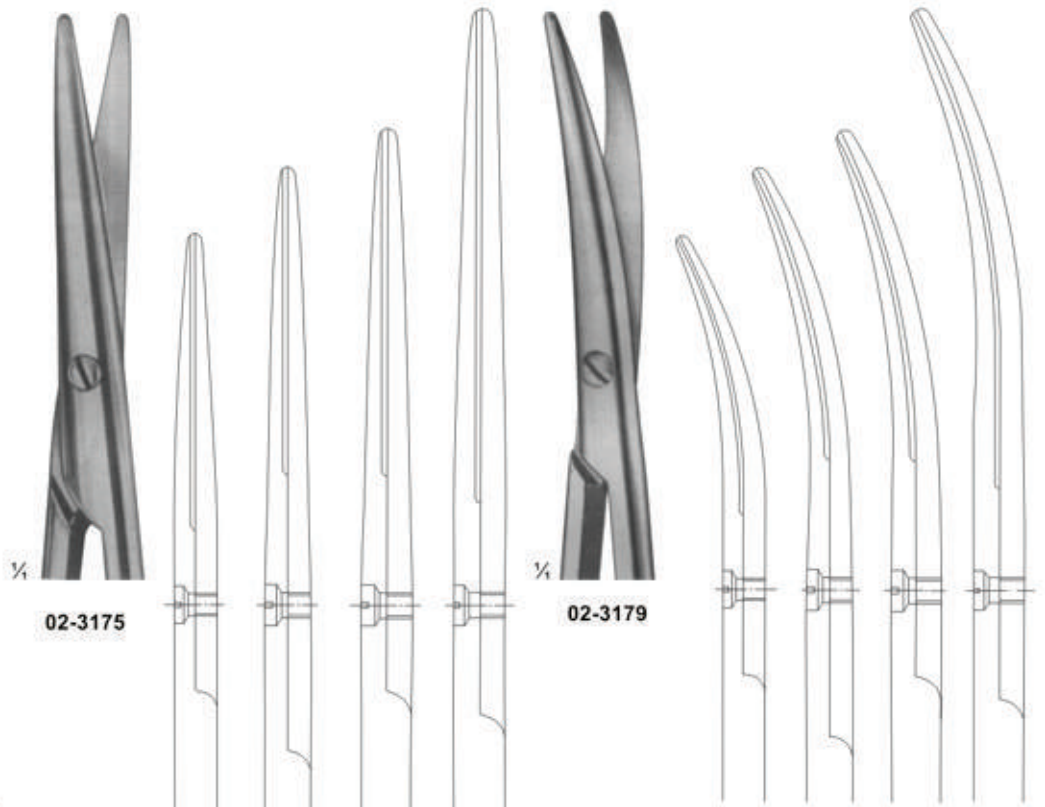

02-3175

02-3179

02-3175  
230 mm

02-3176  
250 mm

02-3177  
280 mm

02-3178  
305 mm

02-3179  
230 mm

02-3180  
250 mm

02-3181  
280 mm

02-3182  
305 mm



# Vessel Scissors

Splenor Surgicals

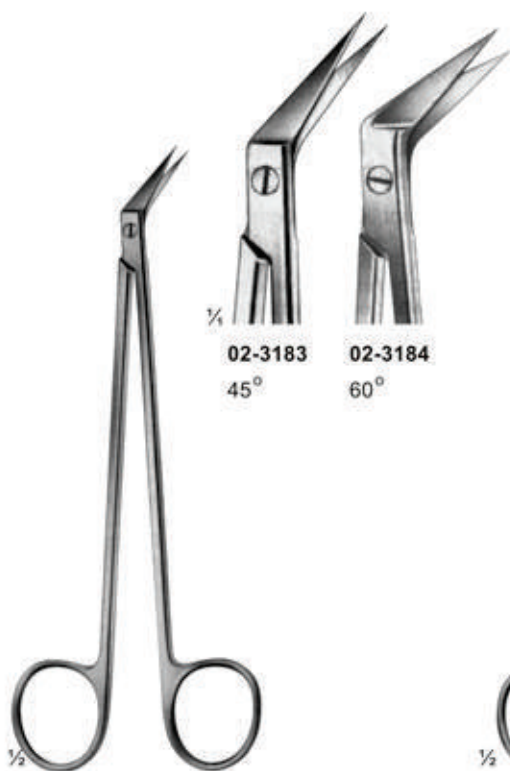

02-3183 45°  
02-3184 60°

02-3183 - 02-3184  
DE BAKKEY  
Size: 155 mm

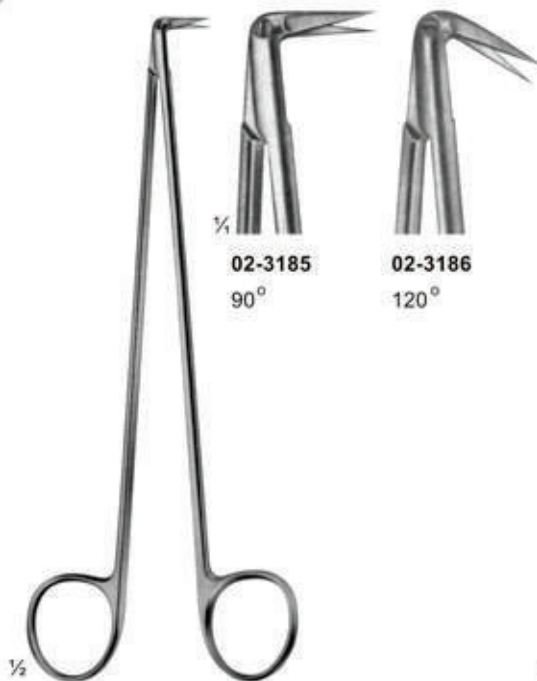

02-3185 90°  
02-3186 120°

02-3185 - 02-3186  
DIETRICH  
Size: 170 mm

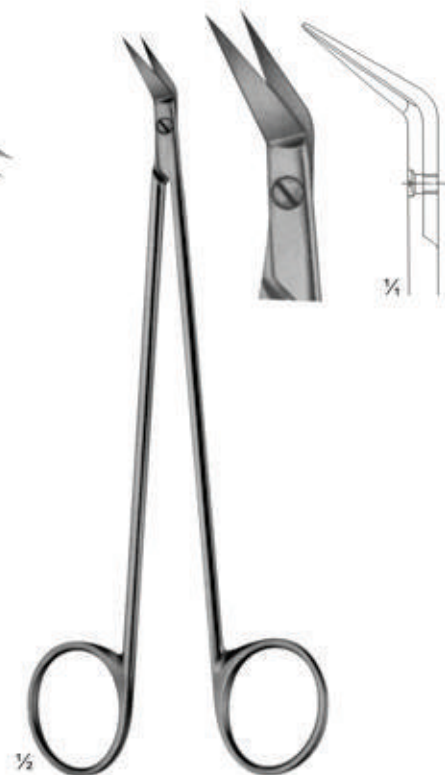

02-3187  
POTTS-SMITH  
Size: 180 mm  
55° Angled on Flat



02-3188 60°

02-3188  
POTTS-SMITH  
Size: 180 mm

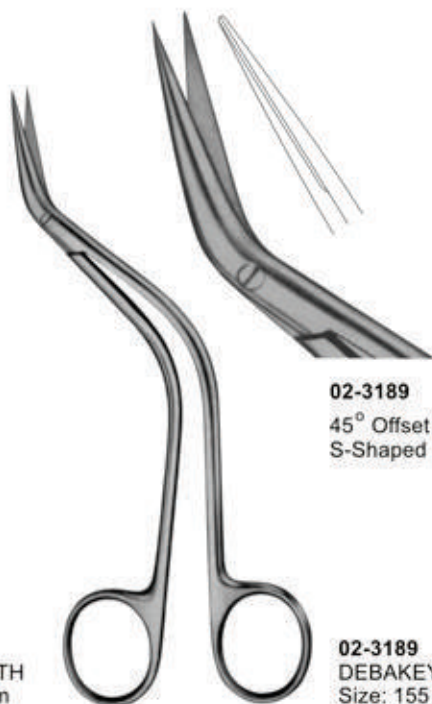

02-3189  
45° Offset Scissors  
S-Shaped

02-3189  
DEBAKEY  
Size: 155 mm



02-3190 55°

02-3190  
FAVOLORO  
Coronary Artery  
Scissors  
Size: 140 mm



**02-3191**  
OLIVECRONA  
Dura Scissors



**02-3192**  
STRULLY  
Pointed  
Size: 220 mm

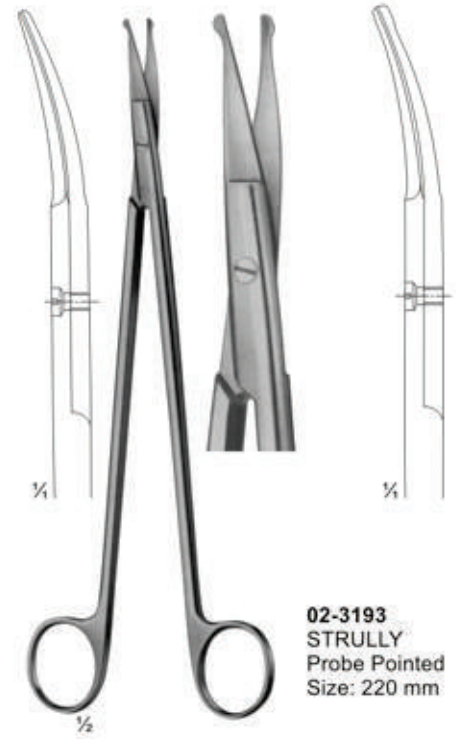

**02-3193**  
STRULLY  
Probe Pointed  
Size: 220 mm

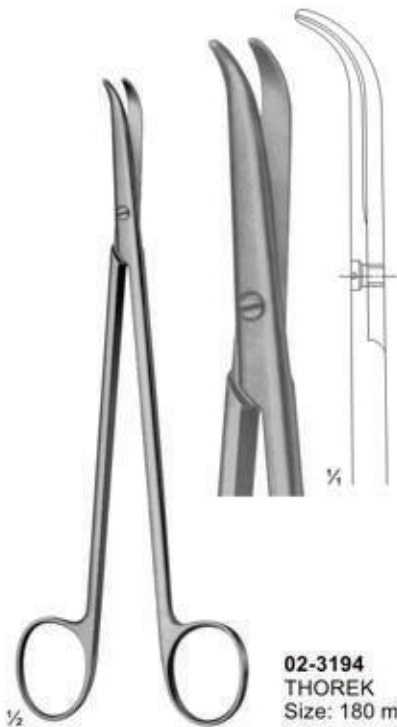

**02-3194**  
THOREK  
Size: 180 mm

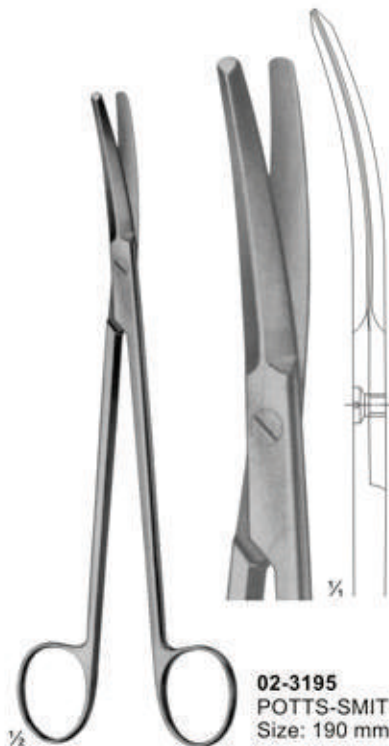

**02-3195**  
POTTS-SMITH  
Size: 190 mm



**02-3196**  
SATINSKY  
Size: 245 mm



# Delicate, Nasal and Tonsil Scissors

## Splenor Surgicals



**02-3197**  
1 Finely Toothed Blade  
Size: 130 mm

**02-3198**  
LOCKLIN  
Curved Sideways,  
1 Toothed Blade  
Size: 155 mm

**02-3199**  
FOMON  
Blades Serrated  
Size: 145 mm

**02-3200**  
COTTLE  
Size: 165 mm

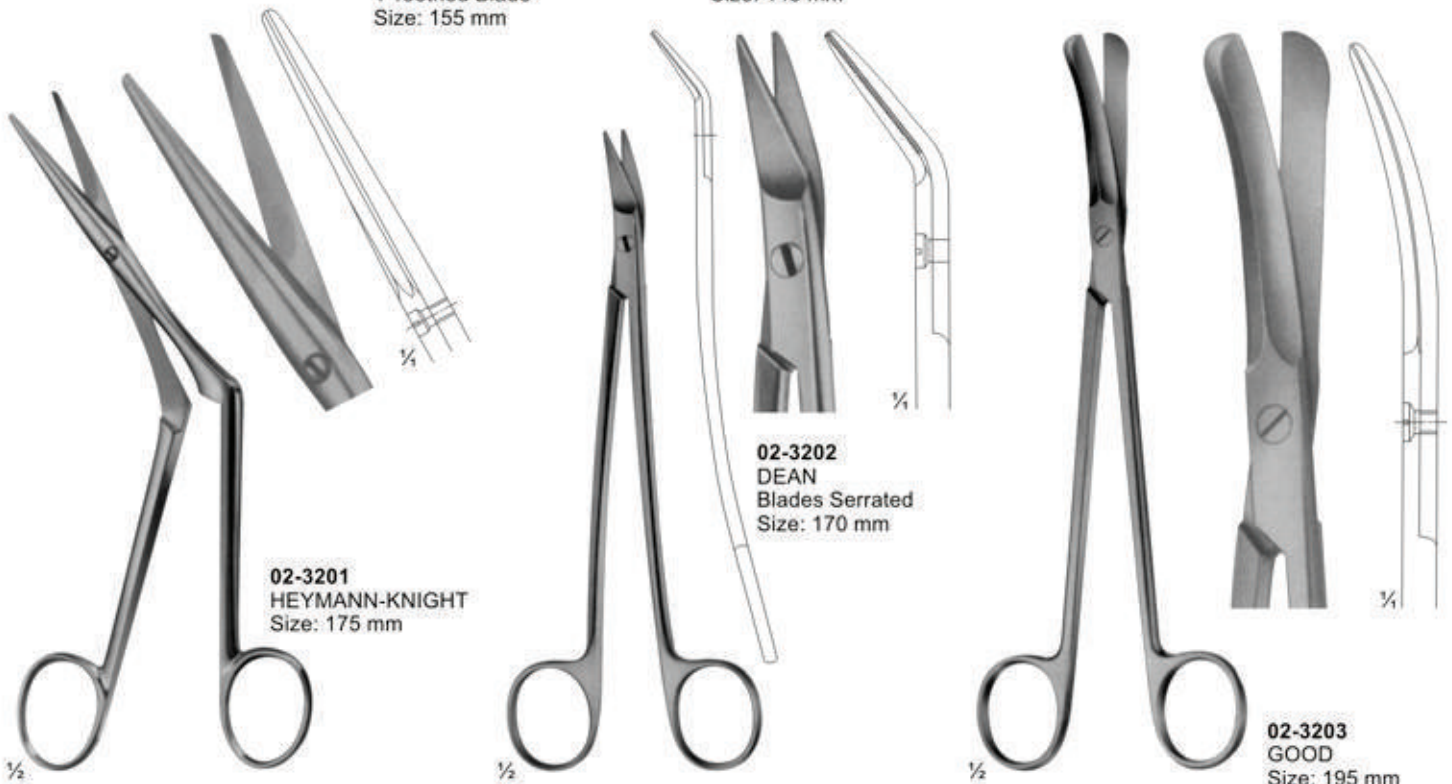

**02-3201**  
HEYMANN-KNIGHT  
Size: 175 mm

**02-3202**  
DEAN  
Blades Serrated  
Size: 170 mm

**02-3203**  
GOOD  
Size: 195 mm



# Bone Shears

*Splenor Surgicals*



**02-3204**  
KILLIAN  
Size: 200 mm



**02-3205 - 02-3206**



**02-3205**  
195 mm



**02-3206**  
225 mm





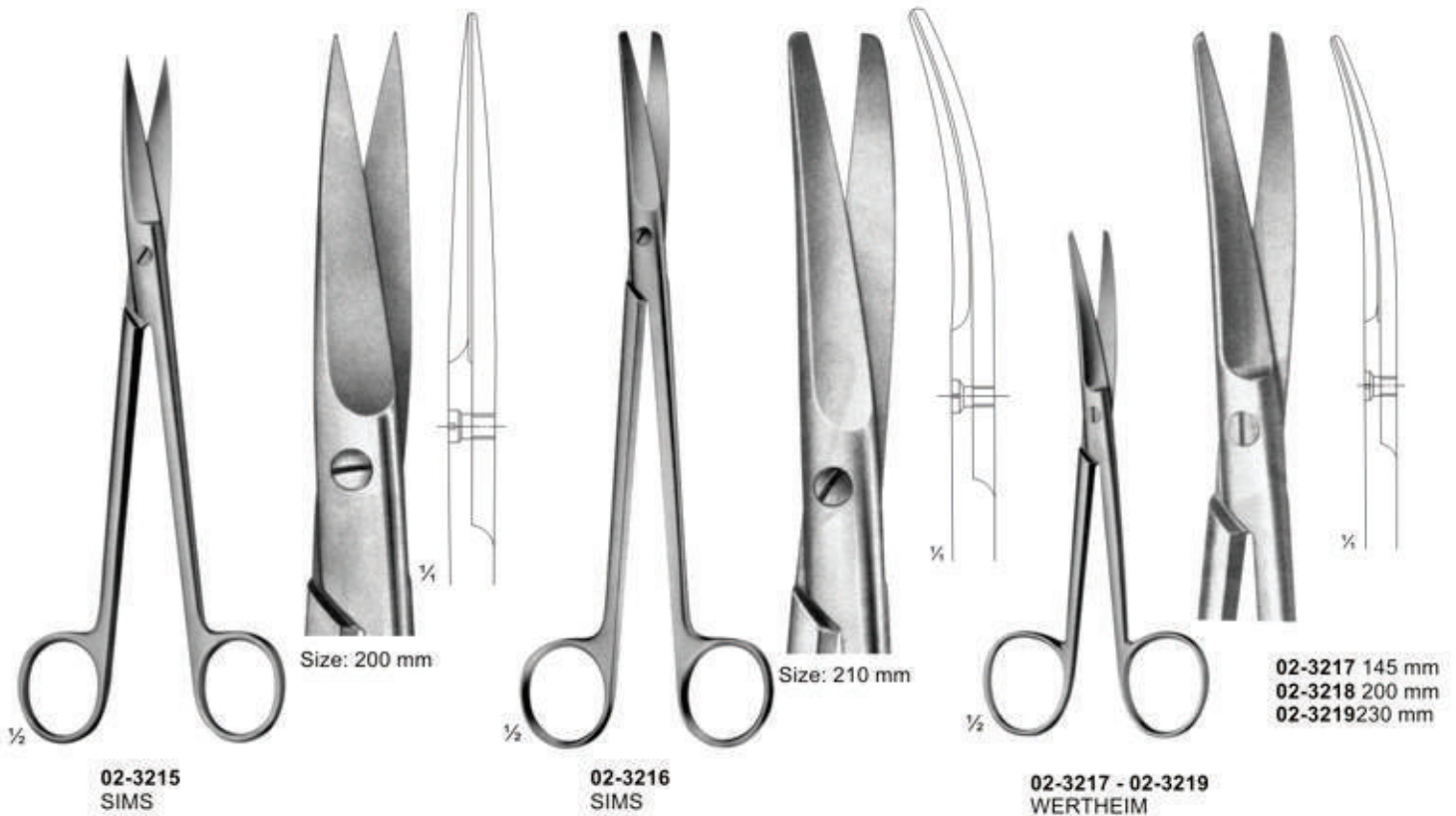
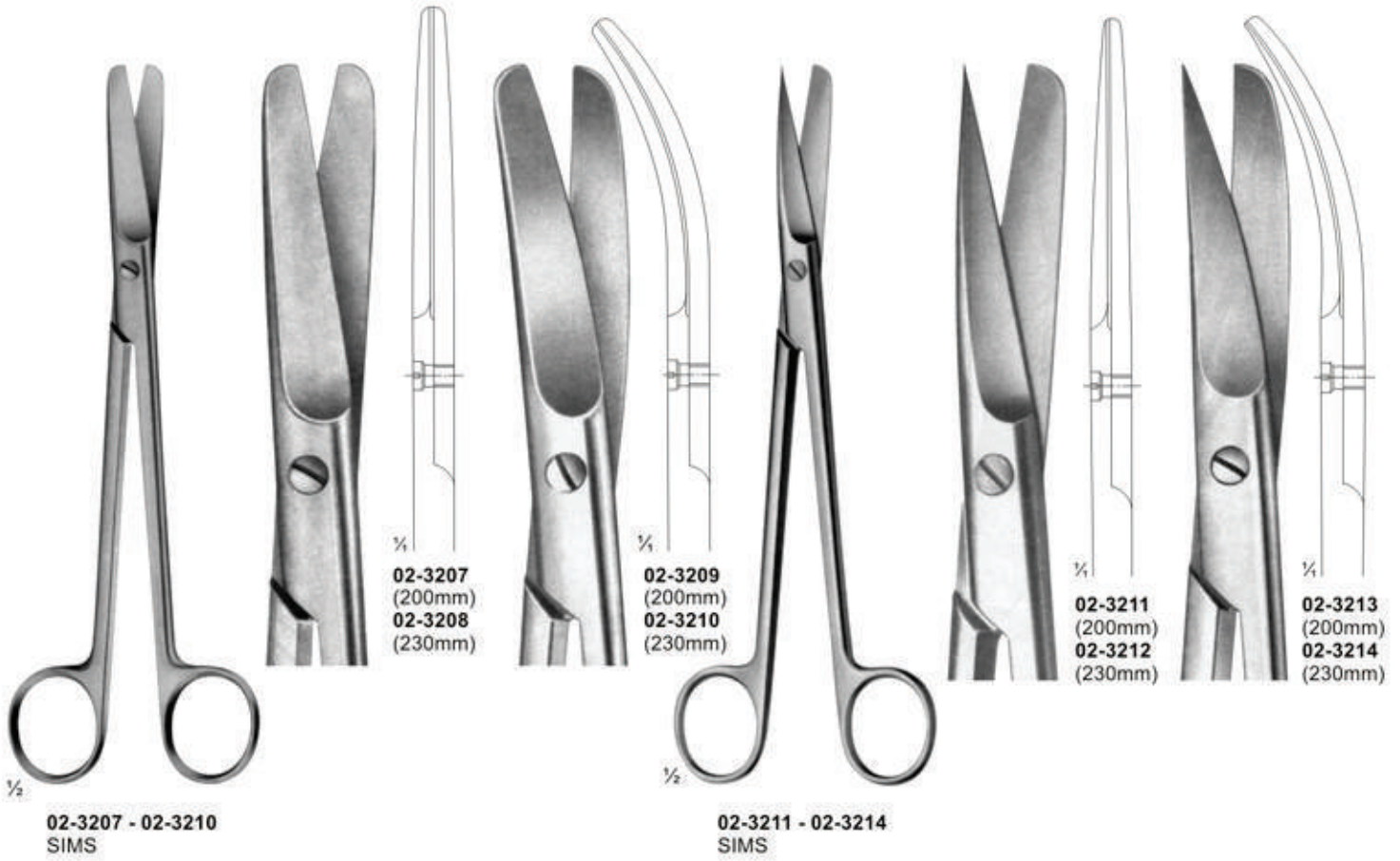

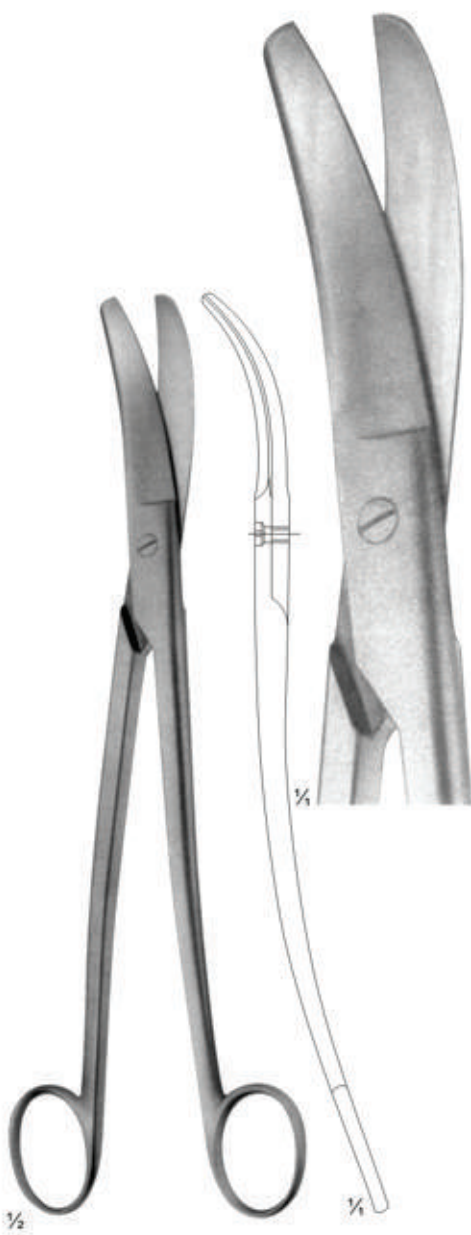

**02-3220**  
SIEBOLD  
Uterine Scissors  
Size: 245 mm

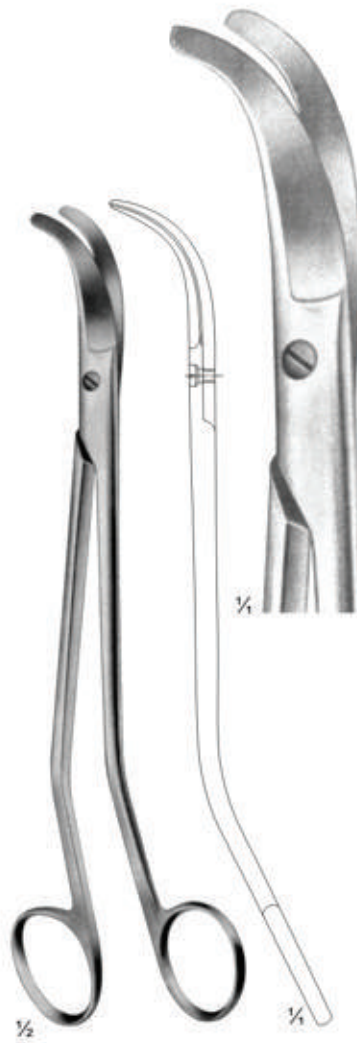

**02-3221**  
BOZEMANN  
Uterine Scissors  
Size: 220 mm

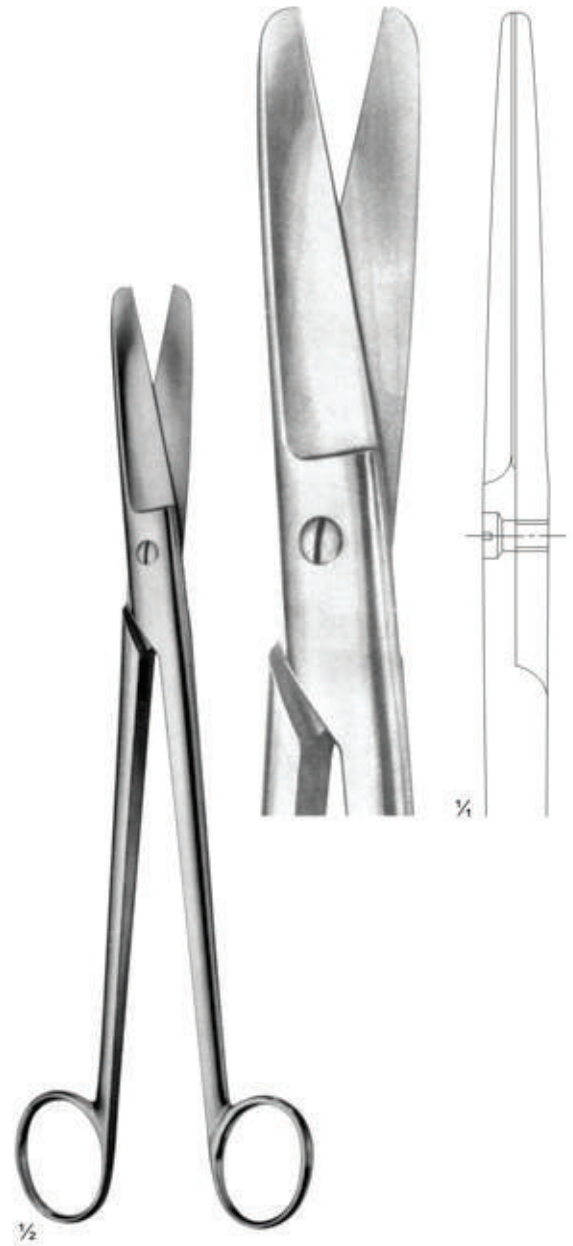

**02-3222**  
SIMS-SIEBOLD  
Uterine Scissors  
Size: 250 mm



# Scissors For Obstetrics

*Splenor Surgicals*



**02-3223**  
SCHUMACHER  
Umbilical Cord Scissors  
Size: 155 mm



**02-3224**  
Umbilical Cord Scissors  
Size: 105 mm

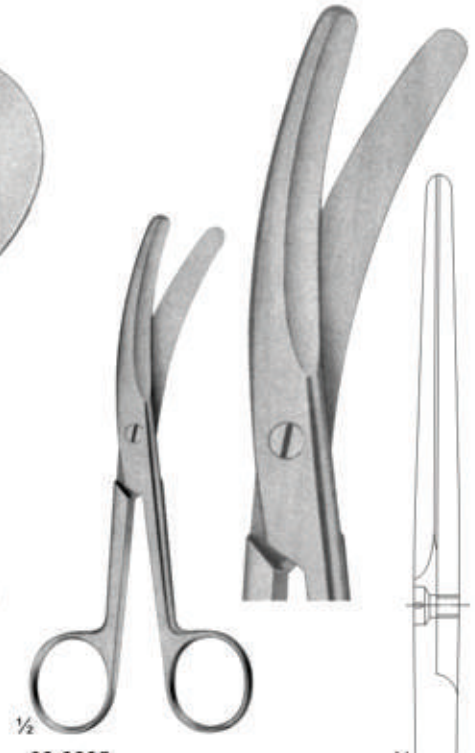

**02-3225**  
Umbilical Cord Scissors



135 mm



**02-3226 - 02-3227**  
BRAUN-STADLER  
Episiotomy Scissors

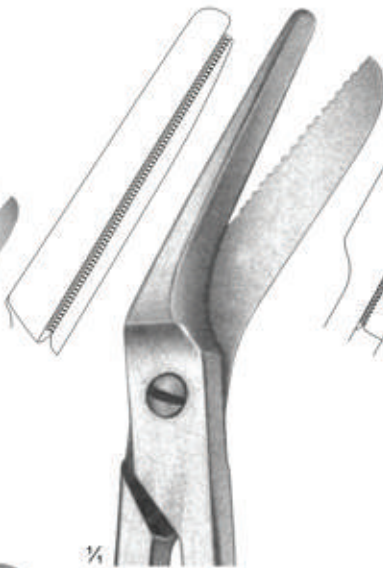

**02-3226**  
145 mm

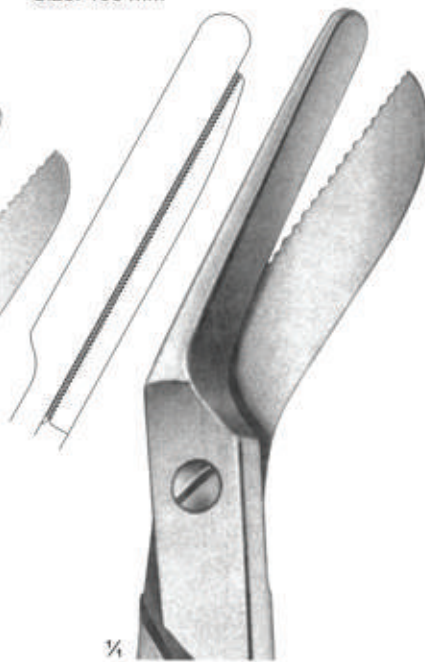

**02-3227**  
200 mm



**02-3228**  
Episiotomy Scissors  
240 mm





# Bowel Scissors, Rectal Scissors

*Splenor Surgicals*



**02-3229**  
Bowel Scissors  
Size: 210 mm

**02-3230**  
Bowel Scissors  
Size: 210 mm

**02-3231**  
LLOYD-DAVIES  
(GOLIGHER'S)  
Rectal Scissors  
Size: 270 mm

**02-3232**  
STELZNER  
Rectal Scissors  
Size: 310 mm



# Ligature Scissors

*Splenor Surgicals*

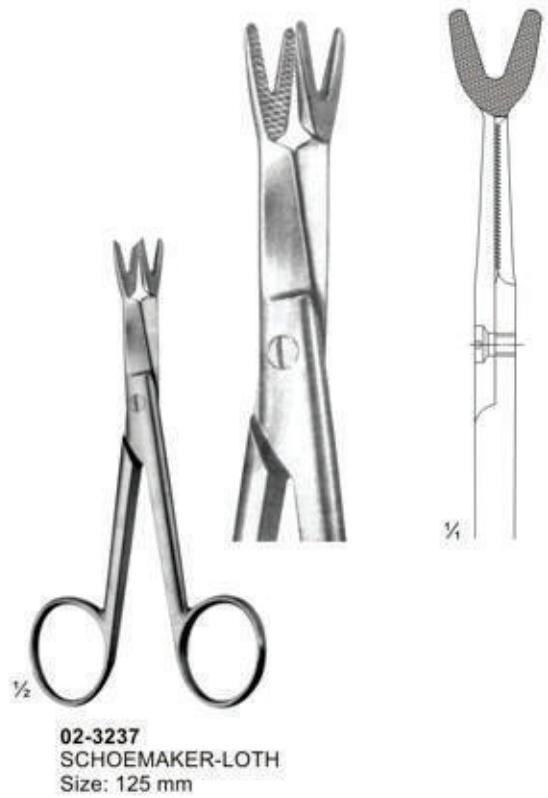



# Wire and Plate Scissors

*Splenor Surgicals*



1/2

02-3238 - 02-3242  
BEEBE  
Size: 110 mm



1/4

02-3238



1/4

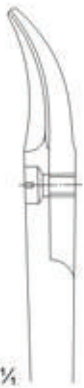

1/4

02-3239



1/4

02-3240  
Broad Blades



1/4

02-3241  
1 Blade Serrated



1/4

02-3242  
NAUJOKS  
Strongly Curved



1/2

02-3243  
1 Blade Serrated  
Size: 120 mm



1/4



1/2

02-3244  
STRACK  
Size: 100 mm



1/4



1/2

02-3245  
HARVEY  
blades serrated  
Size: 125 mm



1/4



# Nail and Bandage Scissors

*Splenor Surgicals*

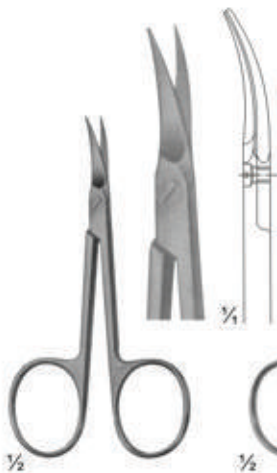

**02-3246**  
NAIL SCISSORS  
Size: 90 mm

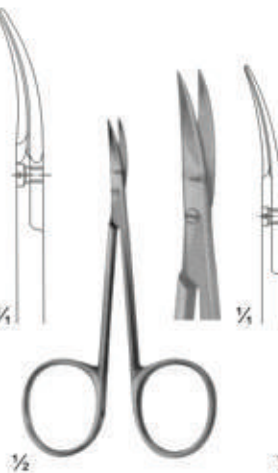

**02-3247**  
NAIL SCISSORS  
especially fine pattern.  
Size: 90 mm



**02-3248**  
BABY NAIL  
SCISSORS  
Size: 85 mm



**02-3249 - 02-3252**  
NAIL SCISSORS  
02-3249(90mm)straight  
02-3250(90mm)curved  
02-3251(100mm)straight  
02-3252(110mm)curved

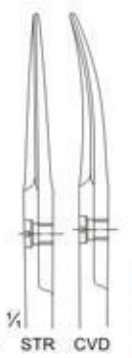

**02-3253 - 02-3255**  
NAIL SCISSORS  
02-3253(95mm)straight  
02-3254(95mm)curved  
02-3255(105mm)straight



**02-3256**  
KNOWLES  
Size: 140 mm

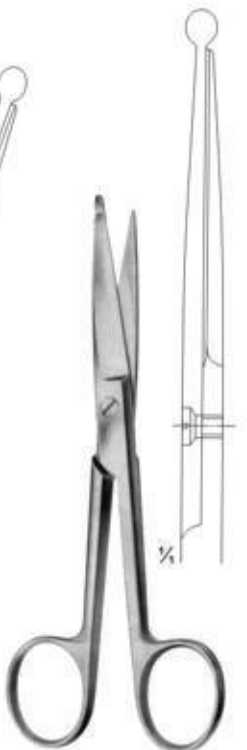

**02-3257**  
KNOWLES  
Size: 145 mm



**02-3258**  
Size: 150 mm



**02-3259**  
SMITH  
Size: 180 mm



**02-3260**  
BANDAGE CUTTING  
SCISSORS  
Size: 310 mm



# Bandage and Cloth Scissors

## Splenor Surgicals



1/2  
**02-3261**  
UNIVERSAL BANDAGE & CLOTH SCISSORS,  
WITH TOOTHED EDGES, AUTO CLEAVABLE up to 143 °c  
180 mm



1/2  
**02-3262**  
LISTER BANDAGE & CLOTH  
SCISSORS, WITH TOOTHED EDGES,  
AUTO CLEAVABLE up to 143 °c  
Size: 145 mm

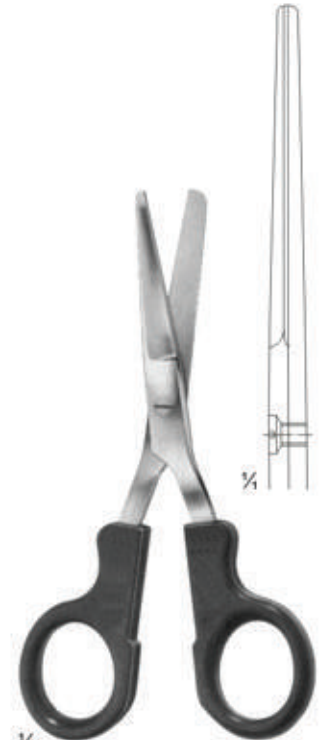

1/2  
**02-3263**  
NURSE'S SCISSORS  
Size: 145 mm  
AUTO CLEAVABLE up to 143 °c

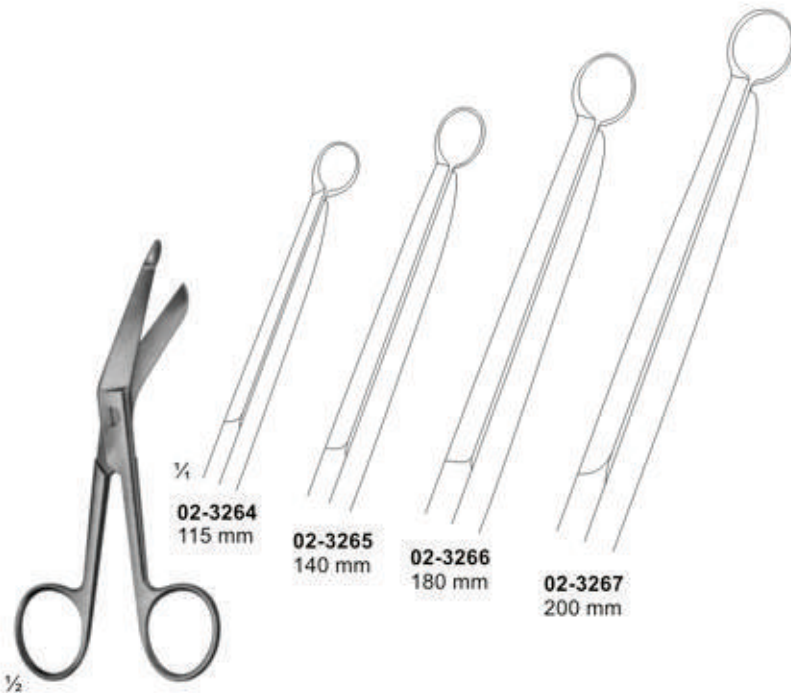

1/2  
**02-3264 - 02-3267**  
LISTER

**02-3264**  
115 mm

**02-3265**  
140 mm

**02-3266**  
180 mm

**02-3267**  
200 mm



1/2  
**02-3268 - 02-3269**  
LISTER

**02-3268**  
155 mm

**02-3269**  
180 mm





# Bandage, Cloth and Plaster Scissors

*Splenor Surgicals*



**02-3270**  
CLOTH SCISSORS  
205 mm



**02-3271**  
BRAUN-STADLER  
Bandage scissors  
225 mm



**02-3272**  
SEUTIN  
Plaster scissors  
230 mm



**02-3273 - 02-3274**  
ESMARCH (Plaster scissors)



**02-3275**  
BRUNS  
Plaster scissors  
235 mm



**02-3276**  
BANDAGE SCISSORS  
235 mm

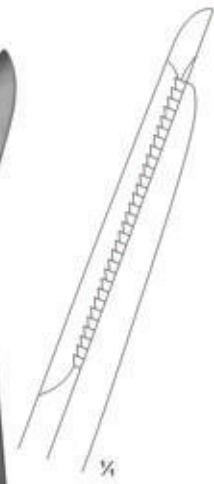

## Section - 03

  
*Splenor Surgicals*



- ★ Hooks, Retractors, Spatulas, Spreaders, Abdoninal Retractors
- ★ Forceps, intestinal Clamps, Specula, Biopsy Forceps, Anuscopes
- ★ Gall Duct Forceps / Probes / Scissors / Kidney Forceps, Urinary Instruments, Trocars

**Pages 115-208**

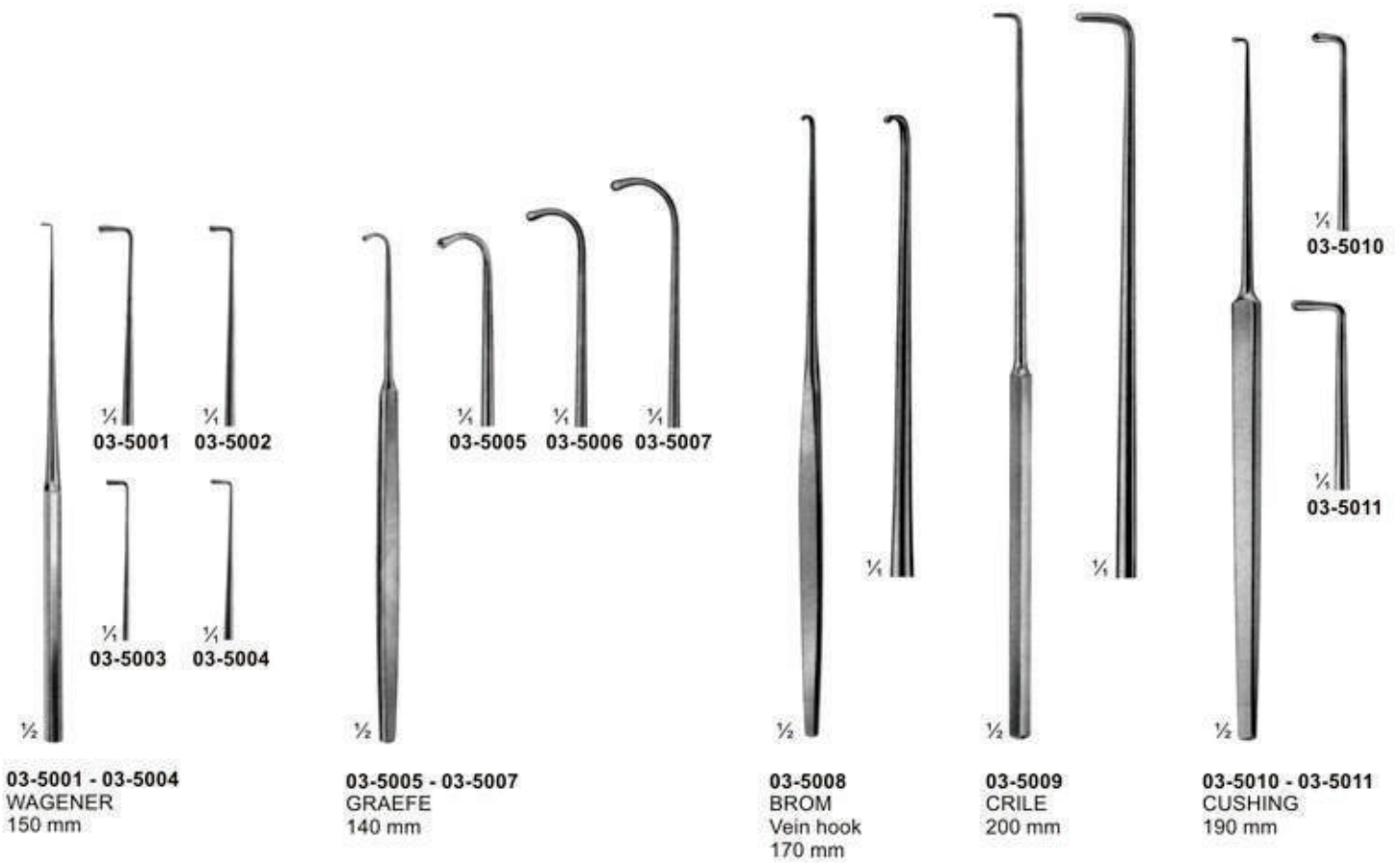



# Nerve - and Vessel Hooks

*Splenor Surgicals*

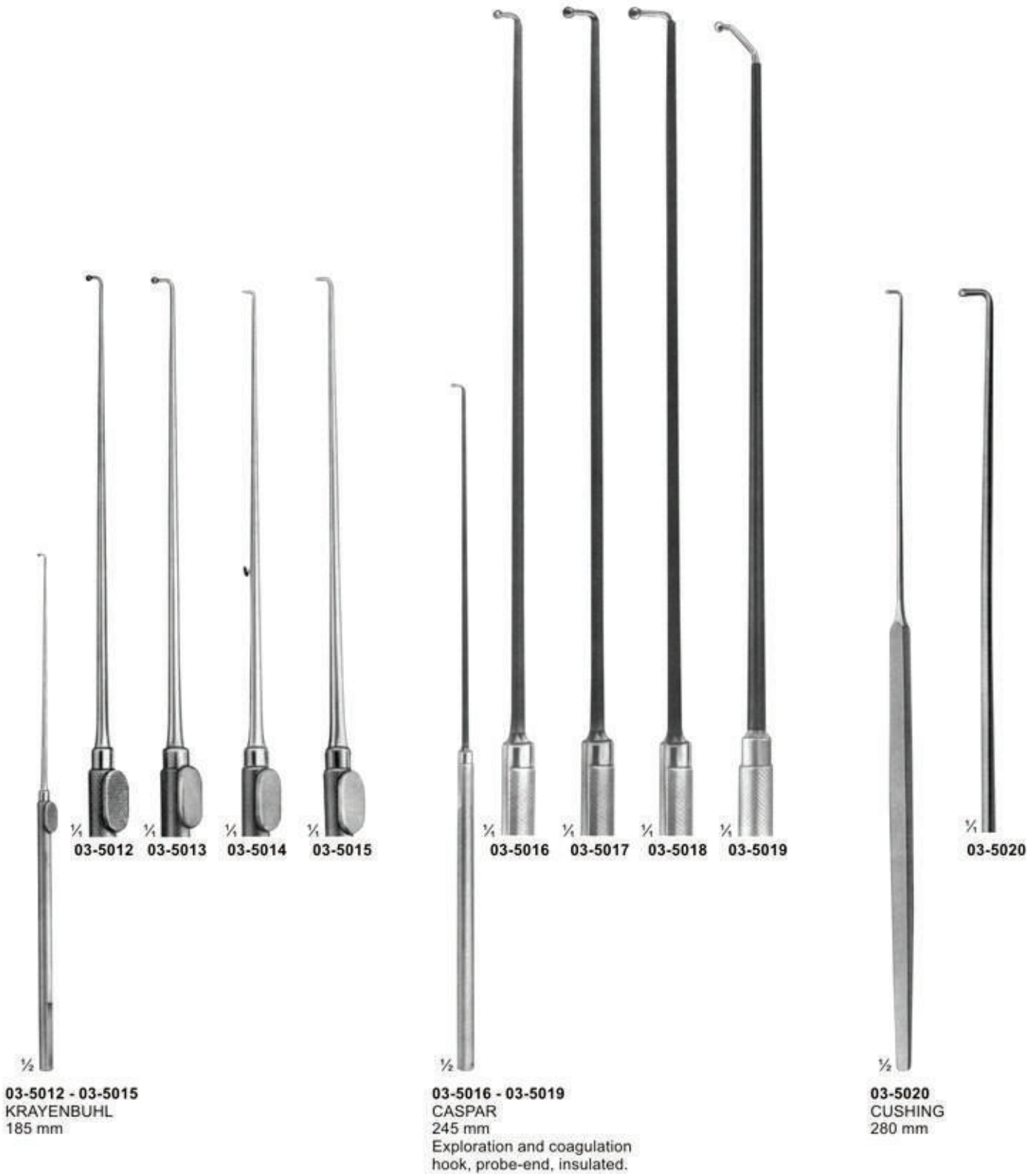



# Fine Wound Retractors (Dura- and Skin Retractors)

## Splenor Surgicals

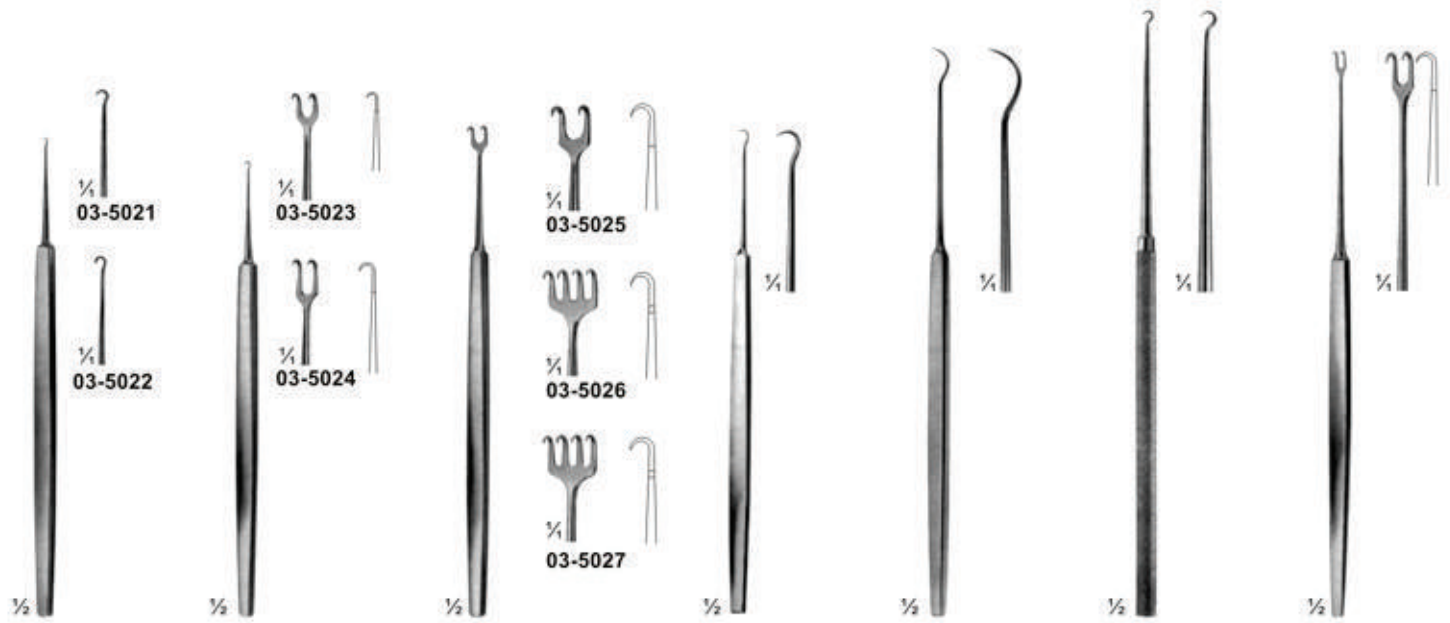

**03-5021 - 03-5022**  
03-5021 Sharp  
03-5022 Blunt  
GRAEFE  
125 mm

**03-5023 - 03-5024**  
03-5023 125 mm  
03-5024 130 mm  
Sharp  
GUTHRIE

**03-5025 - 03-5027**  
03-5025 130 mm  
03-5026 135 mm  
Sharp  
03-5027 135 mm  
Blunt  
ROLLET

**03-5028**  
FRAZIER  
Dura Retractor  
130 mm

**03-5029**  
TOENNIS  
Dura Retractor  
150 mm

**03-5030**  
KILNER  
160 mm

**03-5031**  
FREER  
150 mm

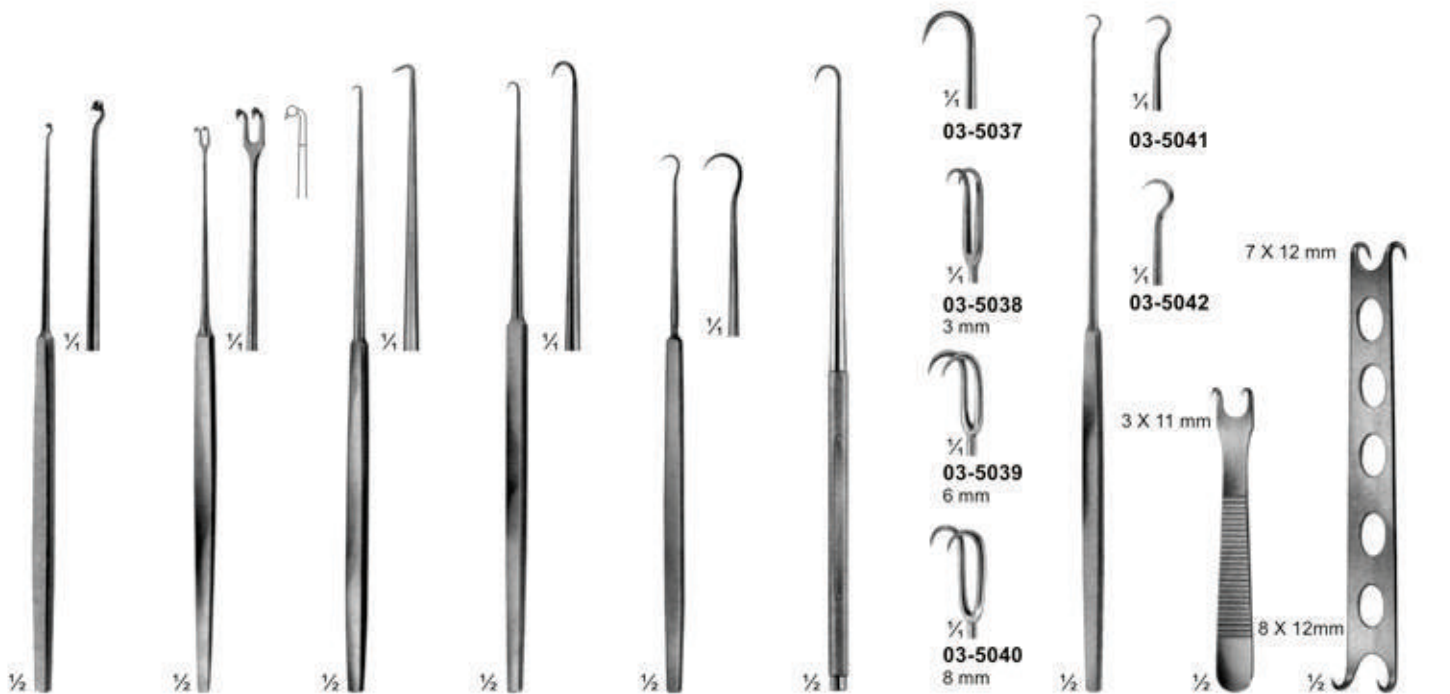

**03-5032**  
MULLER  
150 mm

**03-5033**  
MULLER  
150 mm

**03-5034**  
COTTLE  
160 mm

**03-5035**  
COTTLE  
160 mm

**03-5036**  
JAEGER  
135 mm

**03-5037 - 03-5040**  
JOSEPH  
165 mm

**03-5041 - 5042**  
GILLIES  
180 mm

**03-5043**  
KILNER  
Sharp  
80 mm

**03-5044**  
CONVERSE  
Blunt  
120 mm







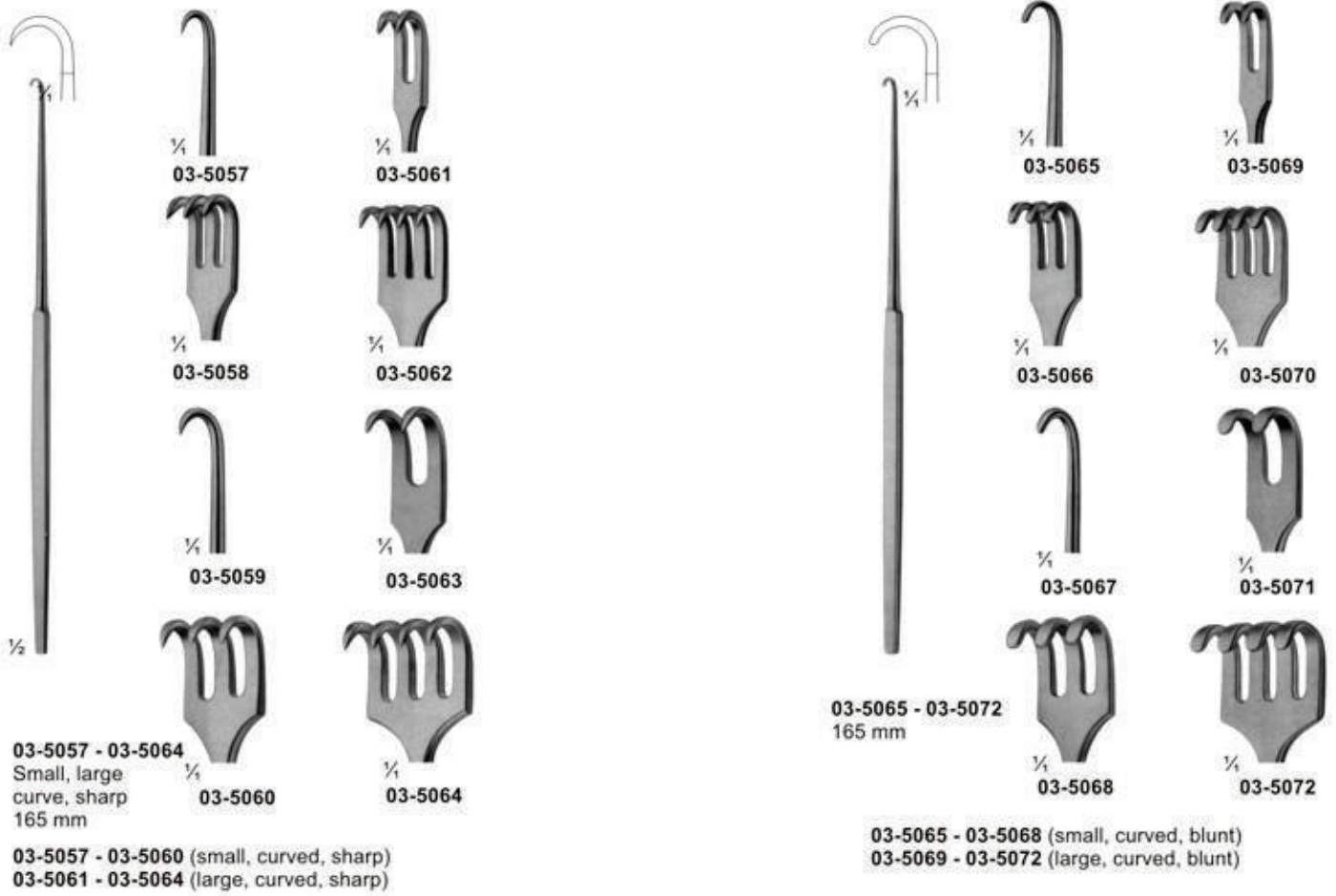



# Wound - Trachea Retractors

# Splenor Surgicals

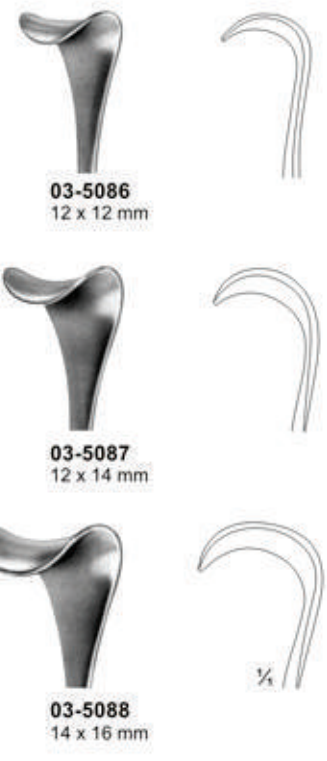
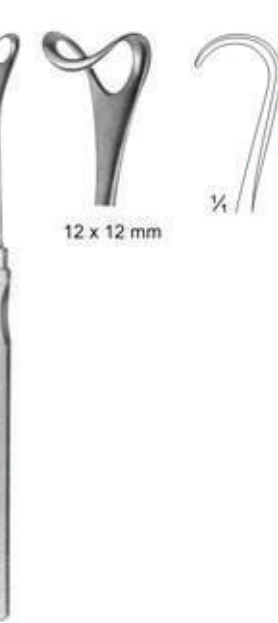

# Retractors With Treangle Handle

 <p>03-5073 MANNERFELT modif. sharp 135 mm</p>	 <p>03-5074 MANNERFELT modif. sharp 155 mm</p>	 <p>03-5075 MANNERFELT modif. sharp 155 mm</p>	 <p>03-5076 MANNERFELT modif. Small curve, sharp 155 mm</p>	 <p>03-5079 - 03-5081 MANNERFELT modif. Large curve, blunt 155 mm</p>
 <p>03-5082 - 03-5085 LANGENBECK- MANNERFELT modif. 155 mm</p>	 <p>03-5082 15 x 6 mm</p> <p>03-5083 20 x 6 mm</p> <p>03-5084 25 x 6 mm</p> <p>03-5085 30 x 8 mm</p>	 <p>03-5086 - 03-5088 MANNERFELT modif. Saddle hooks, 155 mm</p>	 <p>03-5086 12 x 12 mm</p> <p>03-5087 12 x 14 mm</p> <p>03-5088 14 x 16 mm</p>	 <p>03-5089 MANNERFELT modif. Saddle hooks, fenestrated 155 mm</p>



Retractors



03-5090  
FOMON  
145 mm



03-5091 - 03-5092  
160 mm



03-5093 - 03-5094  
LANGENBECK-GREEN  
160 mm



03-5095  
160 mm



03-5096 - 03-5101  
MEYERDING  
Fig. A - Fig. F  
180 mm



A  
03-5096  
18 x 7 mm



B  
03-5097  
16 x 5 mm



C  
03-5098  
7 x 4 mm



D  
03-5099  
5 x 10 mm



E  
03-5100  
11 x 4 mm



F  
03-5101  
6 x 4 mm



03-5102  
4 x 7 mm

03-5103

03-5104

03-5102 - 03-5104  
WILLIGER  
120 mm





# Retractors

# Splenor Surgicals



**03-5105**  
EMMET  
Fistula hook  
220 mm



**03-5106**  
SIMON  
Fistula hook  
220 mm



**03-5107**  
SIMON  
Fistula hook  
220 mm



**03-5108**  
LANGE  
Fistula hook  
230 mm



**03-5109 - 03-5110**  
Tendon hooks  
175 mm

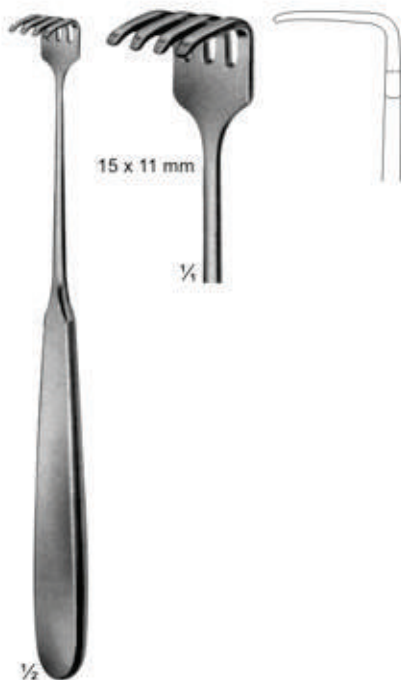

**03-5111**  
KLAPP  
Tendon hooks  
175 mm



# Wound and Vein Retractors

## Splenor Surgicals

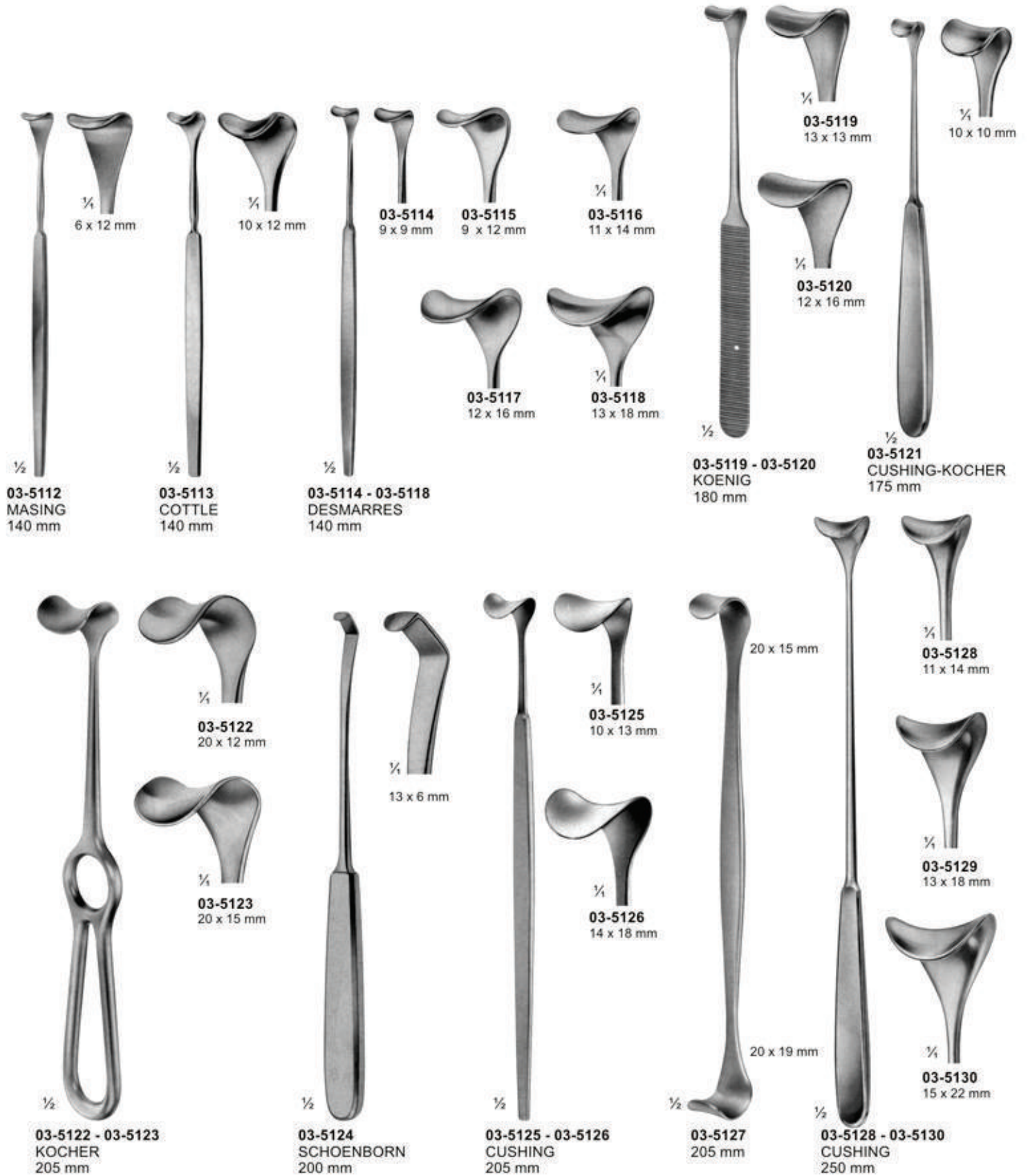

# Retractors





# Retractors

Splenor Surgicals

<p>1/2 <b>03-5145</b> ROUX Set 165 mm</p>	<p>19 x 22 mm <b>03-5146</b> 23 x 30 mm</p>	<p>25 x 26 mm <b>03-5147</b> 28 x 38 mm</p>	<p>28 x 29 mm <b>03-5148</b> 33 x 45 mm</p>	<p>1/2 <b>03-5149</b> ROUX</p>	<p>20 x 22 mm <b>03-5150</b> 25 x 29 mm 150mm</p>	<p>25 x 26 mm <b>03-5151</b> 30 x 38 mm 160mm</p>
<p>1/2 <b>03-5152</b> CZERNY 175 mm</p>	<p>36 mm 38 x 42 mm</p>	<p>47 x 13 mm 41 x 13 mm 37 x 25 mm 42 x 25 mm <b>03-5153</b> MATHIEU 200 mm</p>	<p>1/2</p>	<p>26 x 15 mm 22 x 15 mm 39 x 15 mm 43 x 15 mm <b>03-5154</b> US-ARMY 220 mm</p>	<p>1/2</p>	



# Bone Retractors and Retractors

*Splenor Surgicals*



**03-5155**  
KOCHER  
Sharp  
205 mm



**03-5156**  
KOCHER  
Sharp  
220 mm



**03-5157**  
VOLKMANN  
Sharp  
220 mm



**03-5158**  
VOLKMANN  
Blunt  
220 mm



**03-5159**  
VOLKMANN  
Sharp  
220 mm



**03-5160 - 03-5167**  
VOLKMANN  
225 mm



Sharp

1/2



**03-5160**  
9 x 8 mm



**03-5161**  
9 x 13 mm



**03-5162**  
9 x 19 mm



**03-5163**  
9 x 29 mm



Blunt

1/2



**03-5164**  
8,5 x 8 mm



**03-5165**  
8,5 x 13 mm



**03-5166**  
8,5 x 19 mm



**03-5167**  
8,5 x 29 mm



# Retractors

Splenor Surgicals

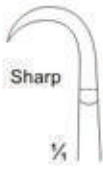

Sharp

1/4



**03-5168**  
9 x 8 mm



**03-5169**  
9 x 13 mm



**03-5170**  
9 x 19 mm



**03-5171**  
9 x 29 mm



**03-5172**  
9 x 40 mm

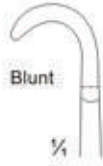

Blunt

1/4



**03-5173**  
8 x 8 mm



**03-5174**  
8 x 13 mm



**03-5175**  
8 x 19 mm



**03-5176**  
8 x 29 mm



**03-5177**  
8 x 40 mm



Semi-Sharp

1/4



**03-5178**  
8,5 x 8 mm



**03-5179**  
8,5 x 13 mm



**03-5180**  
8,5 x 19 mm



**03-5181**  
8,5 x 29 mm

**03-5168 - 03-5181**  
VOLKMANN  
220 mm

1/2



Semi-Sharp

1/4



**03-5182**  
16 x 9 mm



**03-5183**  
16 x 14 mm



**03-5184**  
16 x 20 mm



**03-5185**  
16 x 30 mm

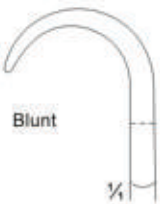

Blunt

1/4



**03-5186**  
15,5 x 9 mm



**03-5187**  
15,5 x 14 mm



**03-5188**  
15,5 x 20 mm



**03-5189**  
15,5 x 30 mm

**03-5182 - 03-5189**  
KOCHER  
220 mm

1/2



# Retractors, Deep form

# Splenor Surgicals



**03-5190 - 03-5191**  
KOERTE  
Handle vertical  
to the blade.  
240 mm



**03-5190**  
8 Prongs, blunt



**03-5191**  
8 Prongs, sharp



**03-5192 - 03-5195**  
ISRAEL  
255 mm

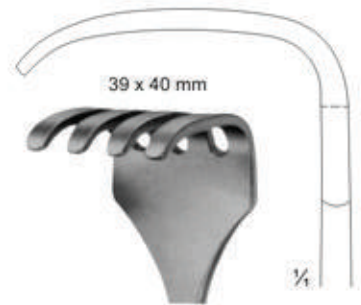

**03-5192**  
4 Prongs, blunt

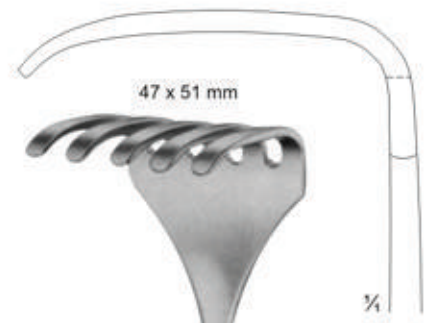

**03-5193**  
5 Prongs, blunt



**03-5194**  
6 Prongs, blunt

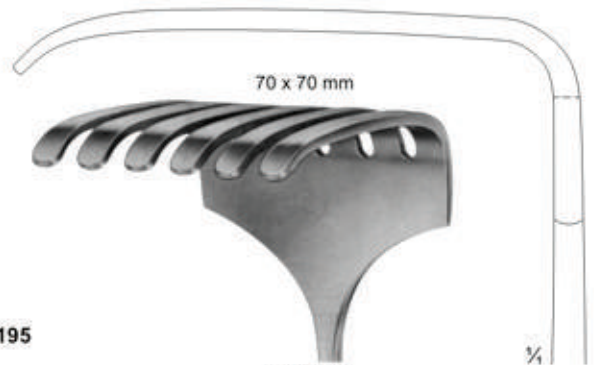

**03-5195**  
6 Prongs, blunt

# Retractors



**03-5196 - 03-5201**  
LANGENBECK  
210 mm

- 03-5196** 28 x 10 mm
- 03-5197** 28 x 14 mm
- 03-5198** 33 x 14 mm
- 03-5199** 28 x 16 mm
- 03-5200** 40 x 10 mm
- 03-5201** 40 x 13 mm



**03-5202 - 03-5210**  
KOCHER-LANGENBECK  
215 mm

- 03-5202** 25 x 6 mm
- 03-5203** 35 x 8 mm
- 03-5204** 35 x 11 mm
- 03-5205** 35 x 15 mm
- 03-5206** 41 x 11 mm
- 03-5207** 55 x 11 mm
- 03-5208** 70 x 14 mm
- 03-5209** 80 x 12mm
- 03-5210** 80 x 16mm



**03-5211**  
LANGENBECK  
215 mm





**Retractors**



**03-5212 - 03-5216**  
KOCHER  
230 mm

½



**03-5217 - 03-5219**  
SAUERBRUCH  
225 mm

½

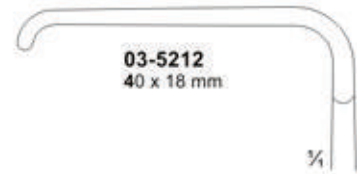

**03-5212**  
40 x 18 mm

¼



**03-5213**  
60 x 20 mm

¼



**03-5214**  
60 x 25 mm

¼

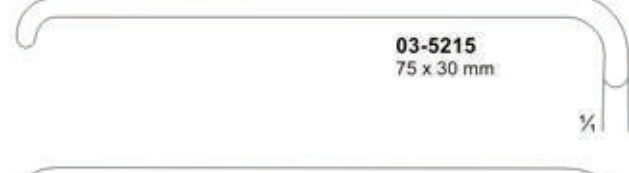

**03-5215**  
75 x 30 mm

¼

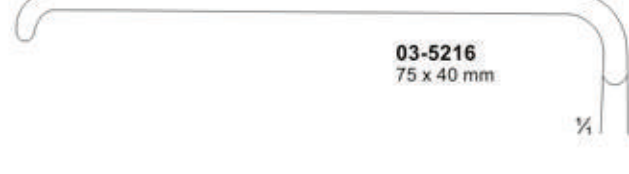

**03-5216**  
75 x 40 mm

¼



**03-5217**  
46 x 16 mm

¼

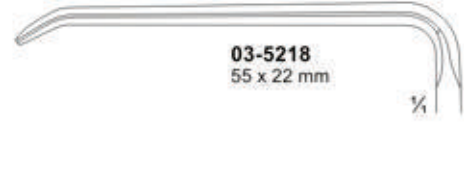

**03-5218**  
55 x 22 mm

¼

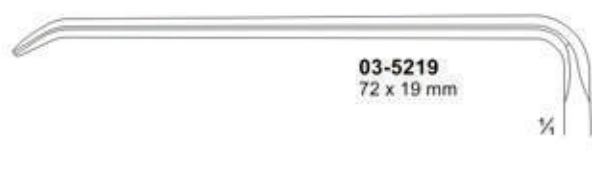

**03-5219**  
72 x 19 mm

¼



**Retractors**



1/2  
**03-5220**  
15 x 15 mm  
220 mm



1/2  
**03-5221**  
20 x 22 mm  
215 mm



1/2  
**03-5222**  
28 x 28 mm  
235 mm



1/2  
**03-5220 - 03-5222**  
MIDDELDORPF



1/2  
**03-5223**  
BUCHS  
205 mm



38 x 18 mm



67 x 17 mm



1/2  
**03-5224**  
CASPAR  
210 mm



1/2  
**03-5225**  
KOCHER  
230 mm

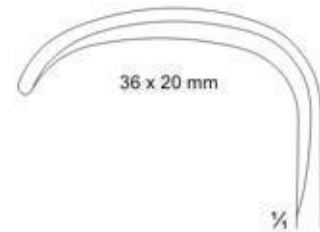

36 x 20 mm

# Retractors



1/2

**03-5226 - 03-5231**  
HOSEL  
250 mm



**03-5226**  
60 x 20 mm

1/4

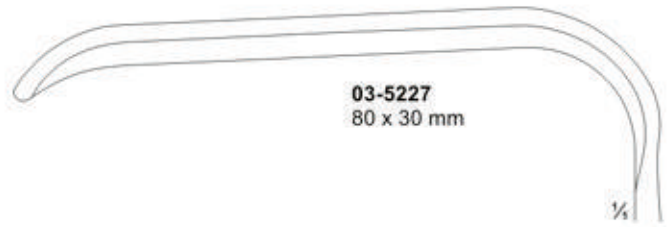

**03-5227**  
80 x 30 mm

1/4

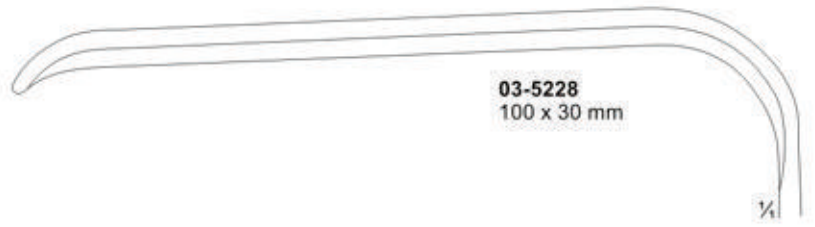

**03-5228**  
100 x 30 mm

1/4

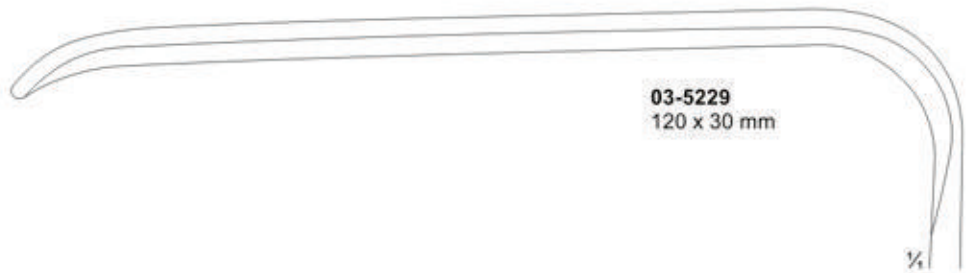

**03-5229**  
120 x 30 mm

1/4



**03-5230**  
140 x 30 mm

1/4



**03-5231**  
140 x 40 mm

1/4



**Retractors**

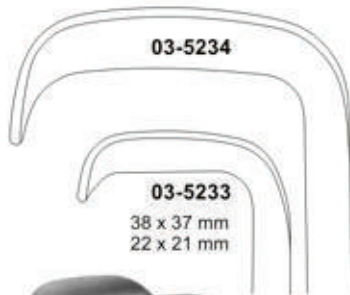

**03-5234**

**03-5233**

38 x 37 mm  
22 x 21 mm



**03-5235**  
23 x 20 mm



**03-5236**  
30 x 29 mm



**03-5237**  
37 x 37 mm



47 x 21 mm



**03-5232**  
RICHARDSON-EASTMAN  
Set

**03-5232** 250 mm

**03-5233** 270 mm

**03-5234**  
Richardson - Eastman.  
complete set of 2

29 x 30 mm  
64 x 43 mm



**03-5235 - 03-5237**  
RICHARDSON  
240 mm

**03-5238**  
RICHARDSON  
240 mm



# Retractors

*Splenor Surgicals*

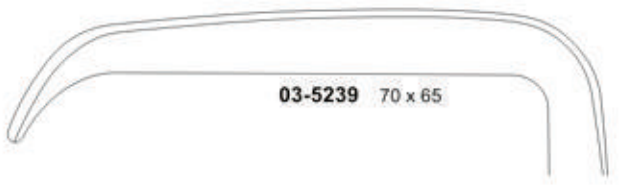

03-5239 70 x 65



03-5240 64 x 54

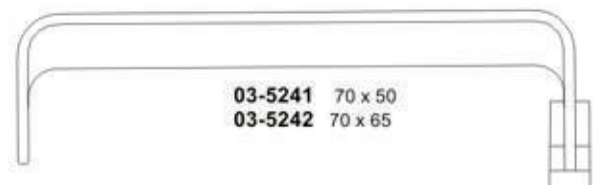

03-5241 70 x 50  
03-5242 70 x 65



1/2

03-5239 - 03-5240  
KELLY  
260 mm



1/2

03-5241 - 03-5242  
MORRIS  
245 mm



# Retractors For Deep Surgery

*Splenor Surgicals*



# Retractors For Deep Surgery





Retractors, Vario Retractor System, Germ. Fed. *Splenor Surgicals*  
 Patent, Germ. Fed. Regd.Des, US-Patent.

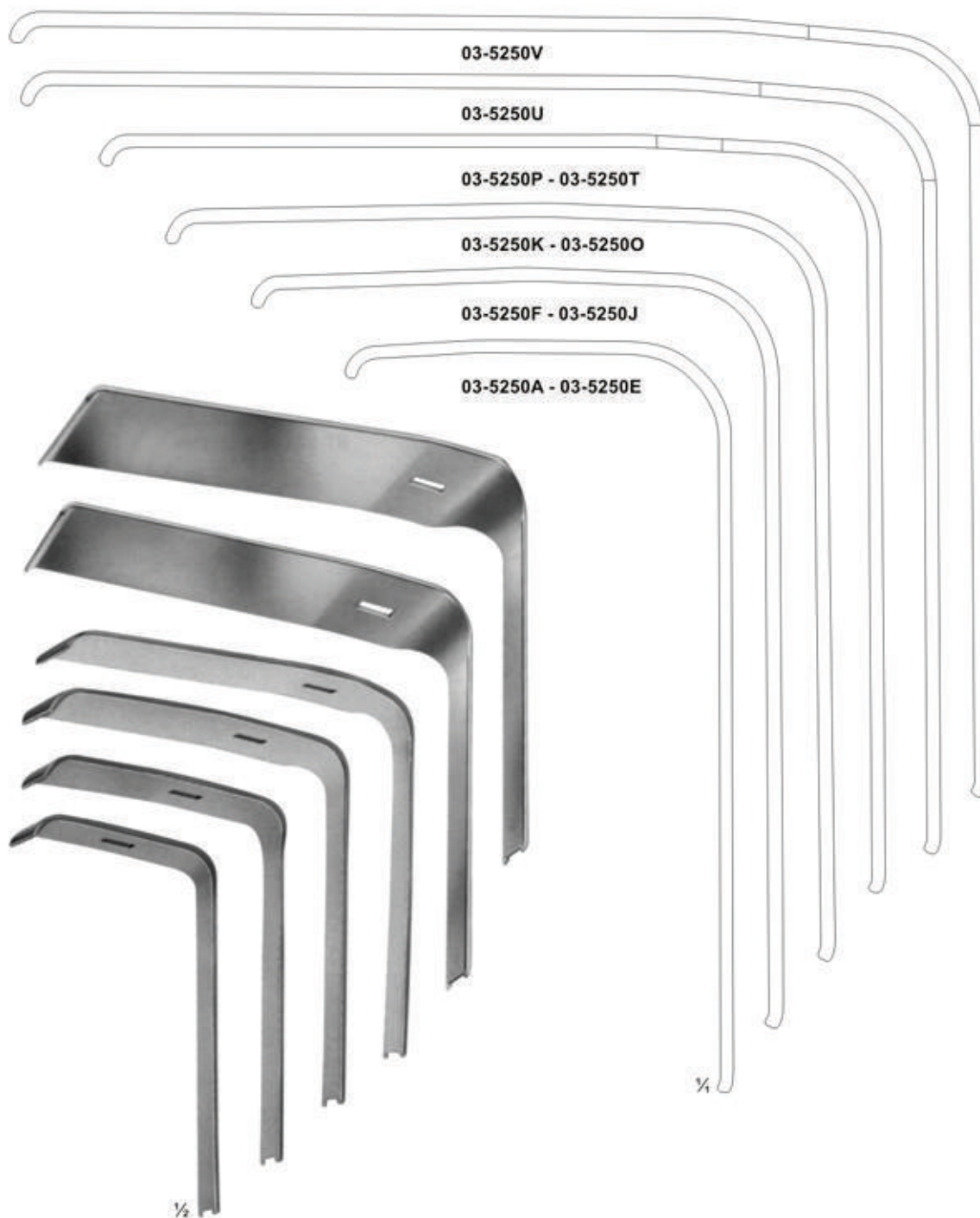

Retractor blades for handles **03-5250**

Depth	Width	14mm	18mm	22mm	26mm	30mm	40mm	50mm
55mm		03-5250A	03-5250B	03-5250C	03-5250D	03-5250E	-	-
75mm		03-5250F	03-5250G	03-5250H	03-5250I	03-5250J	-	-
95mm		03-5250K	03-5250L	03-5250M	03-5250N	03-5250O	-	-
115mm		03-5250P	03-5250Q	03-5250R	03-5250S	03-5250T	-	-
135mm		-	-	-	-	03-5250U	-	-
145mm		-	-	-	-	-	-	03-5250V





Retractors, Vario Retractor System, Germ. Fed. Patent, Germ. Fed. Regd.Des, US-Patent.



- 03-5251 - 03-5257 BRUNNER 275 mm
- 03-5251 80 x 20
- 03-5252 100 x 25
- 03-5253 120 x 25
- 03-5254 130 x 30
- 03-5255 140 x 30
- 03-5256 160 x 30
- 03-5257 180 x 30

1/2



03-5258 Handle with cold light carrier for retractor blades. 280 mm

1/2



Handle arrangement variable



# Retractors, Lung Spatulas

*Splenor Surgicals*

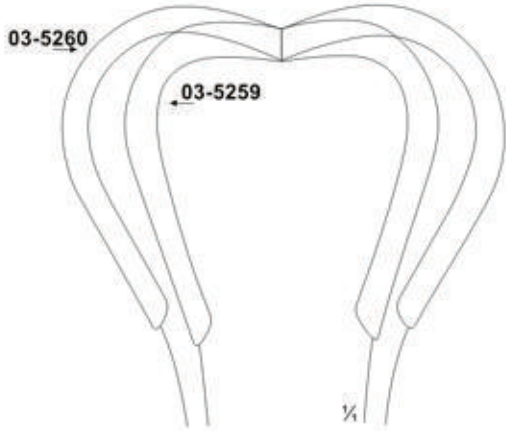

03-5260

03-5259

1/4



123 mm

1/2

03-5259 - 03-5260  
HARRINGTON  
03-5259 123 x 45 mm  
03-5260 123 x 64 mm  
Flexible  
295 mm



40 mm

1/2

03-5261  
ALLISON  
255 mm



54 mm

1/2

03-5262  
ALLISON  
320 mm



# Retractors, Lung Spatulas

*Splenor Surgicals*



**03-5263**  
DAVIDSON  
Scapula Retractor  
195 mm

**03-5264**  
ZENKER  
240 mm

**03-5265**  
Cooley  
25cm / 9"  
Rechts.

**03-5266**  
Cooley  
25cm / 9"  
Rechts.

**03-5267**  
Cooley  
27,5 cm / 10"  
Rechts.

19 mm

**03-5268**  
DEAVER  
180 mm  
Fig. 000

22 mm

**03-5269**  
DEAVER  
215 mm  
Fig. 00

25 mm

**03-5270**  
DEAVER  
235 mm  
Fig. 0



# Retractors, Lung Spatulas

*Splenor Surgicals*





# Retractors, Lung Spatulas

*Splenor Surgicals*



**03-5274**  
DEAVER  
300 mm  
Fig. 3

**03-5275**  
DEAVER  
310 mm  
Fig. 4

**03-5276**  
DEAVER  
320 mm  
Fig. 5



# Retractors, Lung Spatulas

*Splenor Surgicals*



03-5277  
DEAVER  
310 mm  
Fig. 1



03-5278  
DEAVER  
310 mm  
Fig. 3



03-5279  
DEAVER  
305 mm  
Fig. 4



03-5280  
DEAVER  
310 mm  
Fig. 5

Retractors For Deep Surgery (Abdominal Retractors)

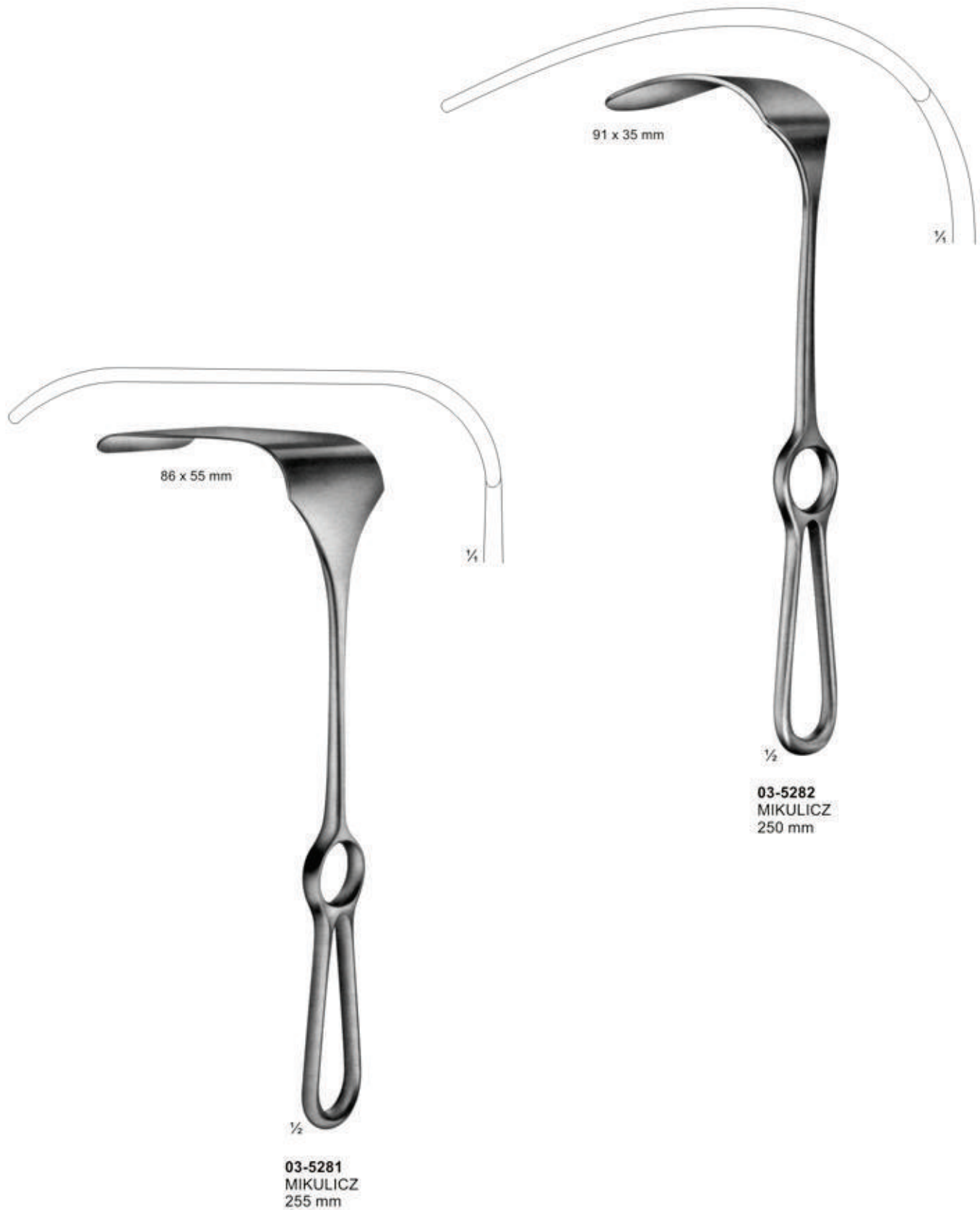



# Retractors For Deep Surgery (Abdominal Retractors)

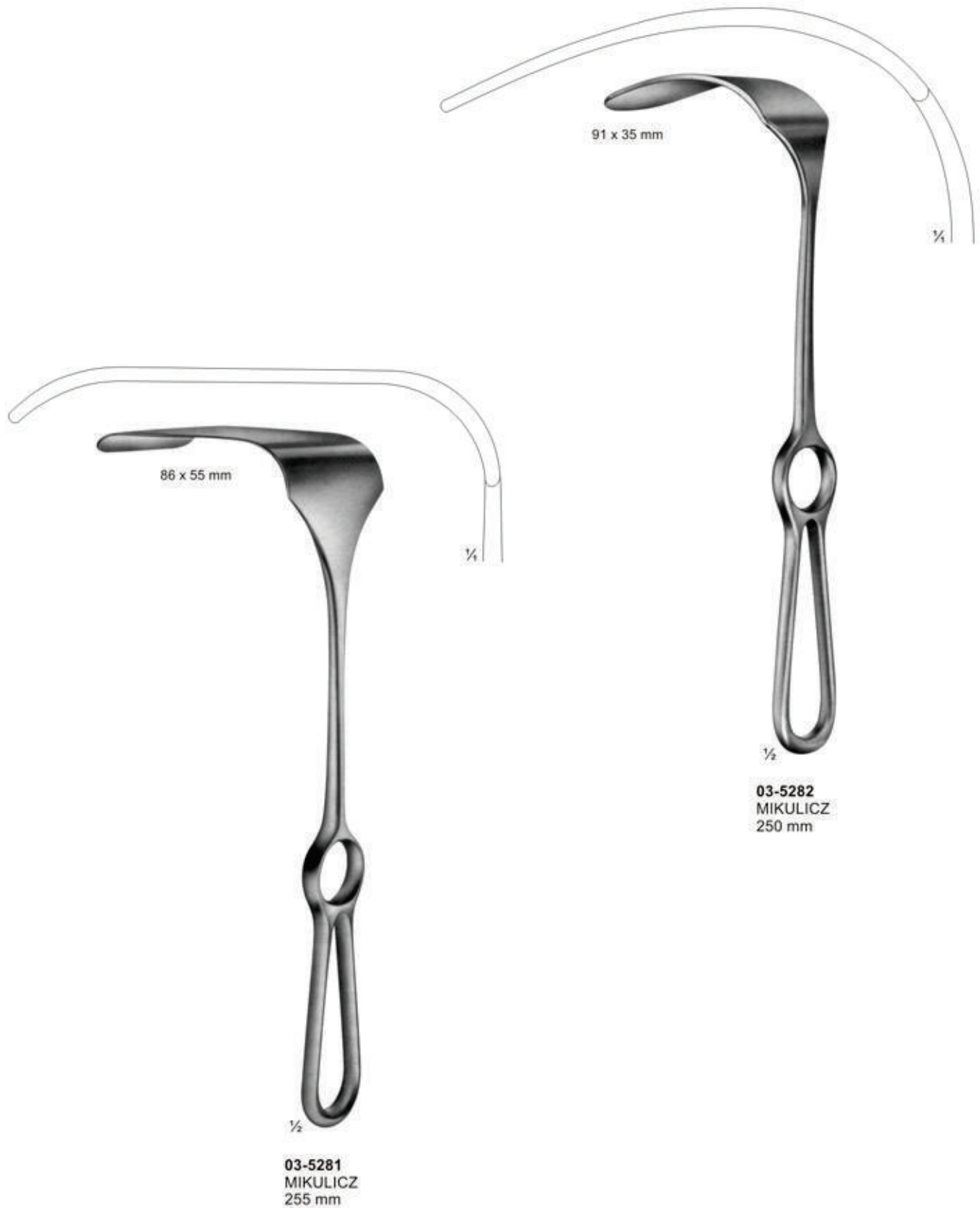



03-5298 Fig.1 32 x 40 mm  
 03-5299 Fig.2 34 x 50 mm  
 03-5300 Fig.3 41 x 60 mm  
 03-5301 Fig.4 46 x 75 mm  
 03-5302 Fig.5 64 x 85 mm

**03-5287 - 03-5297**  
 DOYEN  
 240 mm

**03-5298 - 03-5302**  
 FRITSCH  
 240 mm

**03-5303**  
 DOYEN  
 250 mm

Length of Blades	Width of Blades		
	35mm	45mm	60mm
62mm	03-5287	03-5290	03-5294
92mm	03-5288	03-5291	03-5295
122mm	03-5289	03-5292	03-5296
160mm		03-5293	03-5297



# Abdominal Retractors

Splenor Surgicals



**03-5304 - 03-5308**  
**ROCHARD**  
 310 mm  
**03-5304** 48 x 90 mm  
**03-5305** 48 x 105 mm  
**03-5306** 48 x 120 mm  
**03-5307** 48 x 135 mm  
**03-5308** 48 x 155 mm



**03-5309**  
**ROCHARD**  
 Fixation device for



**03-5310 - 03-5313**  
**DOYEN**  
 280 mm  
**03-5310** 48 x 90 mm  
**03-5311** 48 x 105 mm  
**03-5312** 48 x 120 mm  
**03-5313** 48 x 135 mm



**03-5314**  
**DOYEN-CHILD**  
 Fixation device  
 220 mm



**03-5315**  
 Chain  
 with weight  
 645g  
 790 mm



# Pelvis Retractors

*Splenor Surgicals*

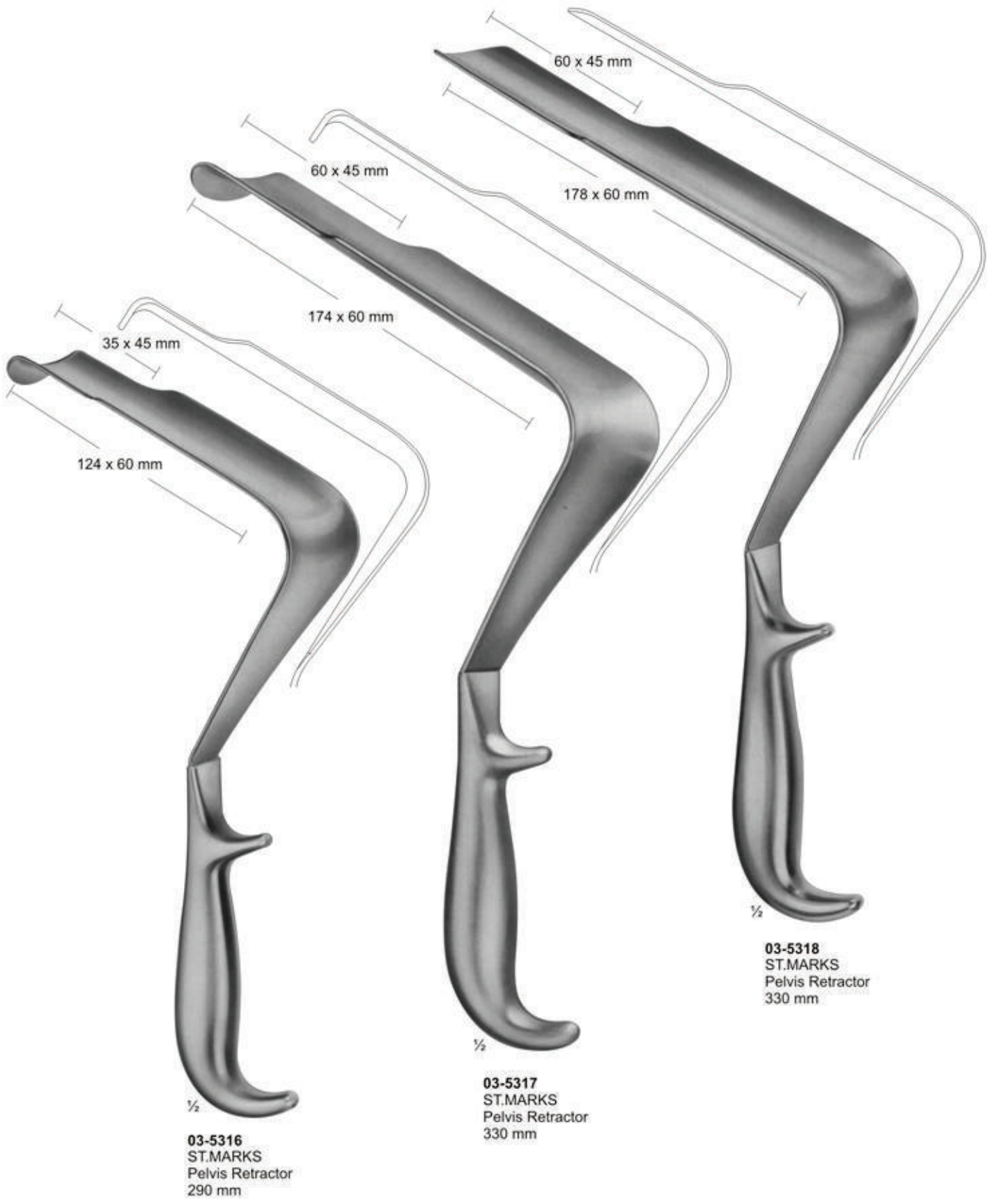

# Abdominal- and Intestinal Spatulas





03-5324  
REVERDIN  
285 mm



03-5325  
HABERER  
Malleable  
305 mm



03-5326 - 03-5328  
03-5326 30 mm  
03-5327 40 mm  
03-5328 50 mm  
Malleable  
330 mm



03-5329  
TUFFIER  
Malleable  
200 mm



# Self-Retaining Retractors

*Splenor Surgicals*



**03-5330**  
BOSE  
60 mm



**03-5331**  
FINSEN  
50 mm



**03-5332**  
FINSEN  
70 mm



**03-5333**  
FINSEN modif.  
75 mm



**03-5334**  
45 mm



**03-5335**  
55 mm



**03-5336**  
MUELLER  
65 mm



**03-5337**  
100 mm



**03-5338**



**03-5339**



**03-5338 - 03-5339**  
03-5338 70 mm  
03-5339 100 mm



**03-5340**  
LOGAN  
modif. REILL  
50 mm



**03-5341**  
JANSEN  
100 mm



**03-5342**  
JANSEN  
100 mm

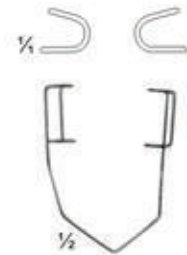

**03-5343**  
BARRAQUER  
45 mm



# Self-Retaining Retractors

*Splenor Surgicals*



**03-5344**  
WEITLANER  
Sharp  
110 mm



**03-5345**  
WEITLANER  
Semi-Sharp  
110 mm



**03-5346**  
WEITLANER  
Blunt  
110 mm



**03-5347**  
WEITLANER  
Sharp  
130 mm



**03-5348**  
WEITLANER  
Semi-Sharp  
130 mm



**03-5349**  
WEITLANER  
Blunt  
130 mm





# Self-Retaining Retractors

*Splenor Surgicals*



**03-5350**  
WEITLANER  
Sharp  
130 mm

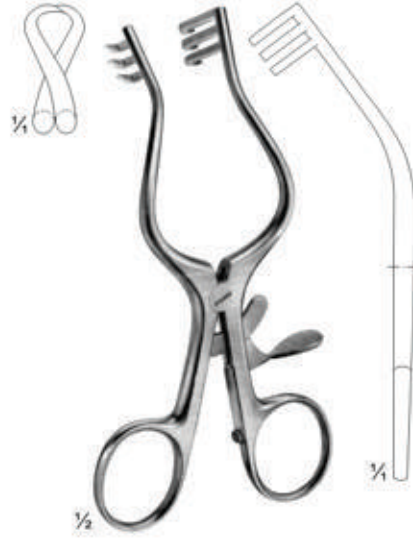

**03-5351**  
WULLSTEIN  
Sharp  
130 mm

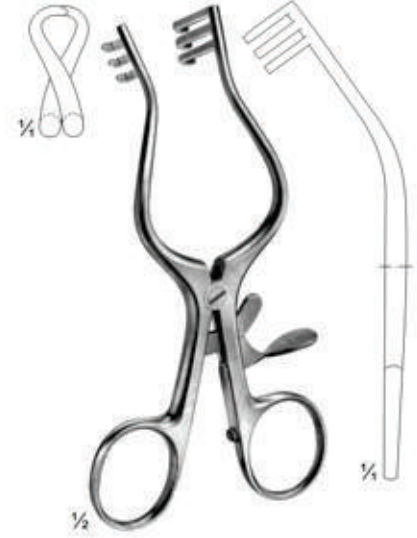

**03-5352**  
WULLSTEIN  
Blunt  
130 mm



**03-5353**  
WEITLANER  
Sharp  
165 mm



**03-5354**  
PLESTER  
Blunt  
110 mm



**03-5355**  
PERKINS  
130 mm



03-5356  
ADSON-BABY  
Blunt  
140 mm



03-5357  
MOLLISON  
Sharp  
155 mm



03-5358  
MAYO-ADAMS  
165 mm

# Self-Retaining Laminectomy Retractors

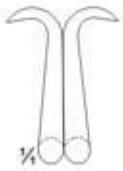

**03-5359**  
ANDERSON-ADSON  
Sharp  
190 mm



**03-5360**  
NORFOLK and  
NORWICH  
Blunt  
220 mm



**03-5361**  
ADSON  
Sharp  
265 mm



# Self-Retaining Laminectomy Retractors

*Splenor Surgicals*



1/4 Sharp



1/4 Semi-Sharp



1/4 Semi-Sharp

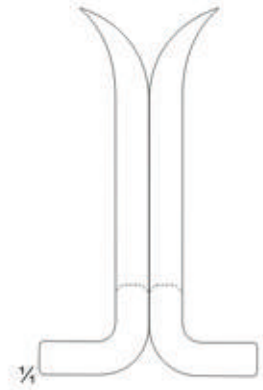

1/4

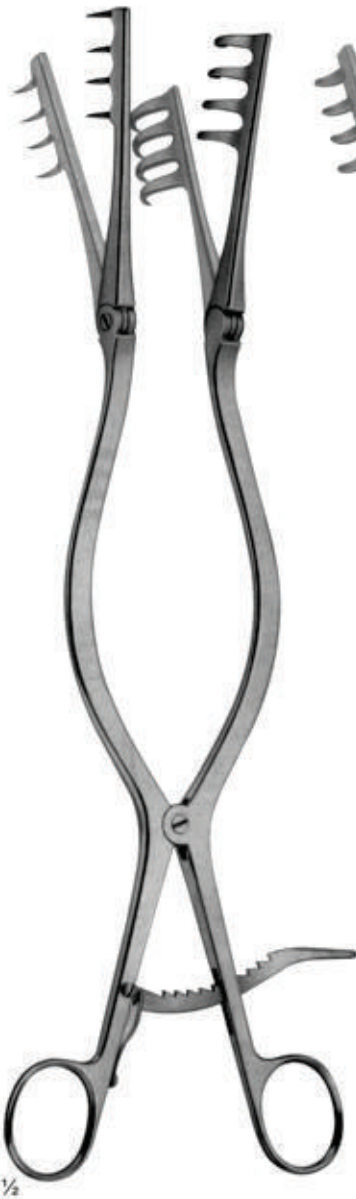

03-5362 - 03-5363  
BECKMANN-ADSON  
Sharp  
310 mm



03-5363  
BECKMANN-ADSON  
Semi-Sharp  
310 mm



03-5364  
ADSON  
Semi-Sharp  
320 mm



03-5365  
BECKMANN-EATON  
Sharp  
320 mm



# Special Retractors

# Splenor Surgicals



1/2

**03-5366**  
JOLL ( FRIEDMAN )  
Thyroid- and Vaginal Retractor  
155 mm



1/2

**03-5367**  
JACKSON BURROWS  
Retractor, blunt  
185 mm

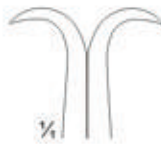

1/4



1/2

**03-5369**  
GELPI  
Skin- and Vaginal Retractor  
175 mm

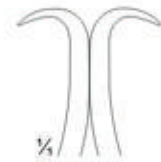

1/4



1/2

**03-5370**  
DE BAKEY  
Femur Retractor  
145 mm



1/4



1/2

**03-5368**  
GELPI  
Vaginal Retractor  
135 mm

# Self Retaining Retractors for Laminectomy and other Operations



**03-5371**  
**SCOVILLE-RICHTER**  
 Retractor with 1 pair  
 blades reversible type.  
 The Retractor bar and shanks  
 may be easily rotated 180° when  
 blades are in situ.



**03-5372**  
 62 x 52 mm    62 x 37 mm  
 PR= Pair



**03-5373**  
 47 x 51 mm



**03-5374**  
 30 x 40 mm



**03-5375**  
 37 x 62 mm

# Retractors for Cervical Spine



**03-5376**  
CLOWARD modif.  
Spreader Only  
Consisting of:  
Spreader Only  
**03-5377** 1 Blade  
**03-5378** 1 Blade  
**03-5379** 1 Blade  
**03-5380** 1 Blade  
**03-5381** 1 Blade



Blades only used for **03-5376**



# Retractors for Cervical Vertebral Column

*Splenor Surgicals*

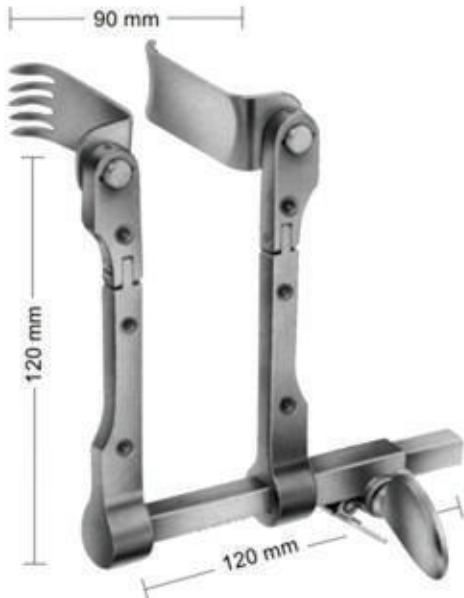

**03-5387**  
CASPAR  
Retractor, adjustable, consisting of:  
5 medial blades (03-5389 - 03-5393) 5 Lateral  
blades. (03-5394 - 03-5398) and the retractor  
only By Reversing the Screw,  
The Retractor Can be Used From Both Sides

To be used preferably for transverse retraction.



**03-5388**  
CASPAR  
Counter retractor, adjustable,  
consisting of: 5 blades. (03-5399 - 03-5403)  
and the retractor only

To be used preferably for  
up and down retraction.



**03-5389** 40 x 23 mm  
**03-5390** 45 x 23 mm  
**03-5391** 50 x 23 mm  
**03-5392** 55 x 23 mm  
**03-5393** 60 x 23 mm  
Medial blades

**03-5394** 40 x 23 mm  
**03-5395** 45 x 23 mm  
**03-5396** 50 x 23 mm  
**03-5397** 55 x 23 mm  
**03-5398** 60 x 23 mm  
Lateral blades

**03-5399** 45 x 23 mm  
**03-5400** 50 x 23 mm  
**03-5401** 55 x 23 mm  
**03-5402** 60 x 23 mm  
**03-5403** 65 x 23 mm  
Blunt blades

**03-5404** 50 x 25 mm  
**03-5405** 60 x 25 mm  
Blunt blades,  
for harvesting of the  
fusion graft from the  
iliac crest

**03-5406** 40 x 25 mm  
**03-5407** 45 x 25 mm  
**03-5408** 50 x 25 mm  
**03-5409** 55 x 25 mm  
**03-5410** 60 x 25 mm  
Medial Titan blades  
semi transparent to x-ray

**03-5411** 40 x 25 mm  
**03-5412** 45 x 25 mm  
**03-5413** 50 x 25 mm  
**03-5414** 55 x 25 mm  
**03-5415** 60 x 25 mm  
Lateral Titan blades  
semi transparent to x-ray





# Lamina Spreaders

*Splenor Surgicals*



**03-5416**  
CLOWARD  
155 mm



**03-5417**  
CLOWARD  
135 mm



**03-5418**  
INGE  
170 mm

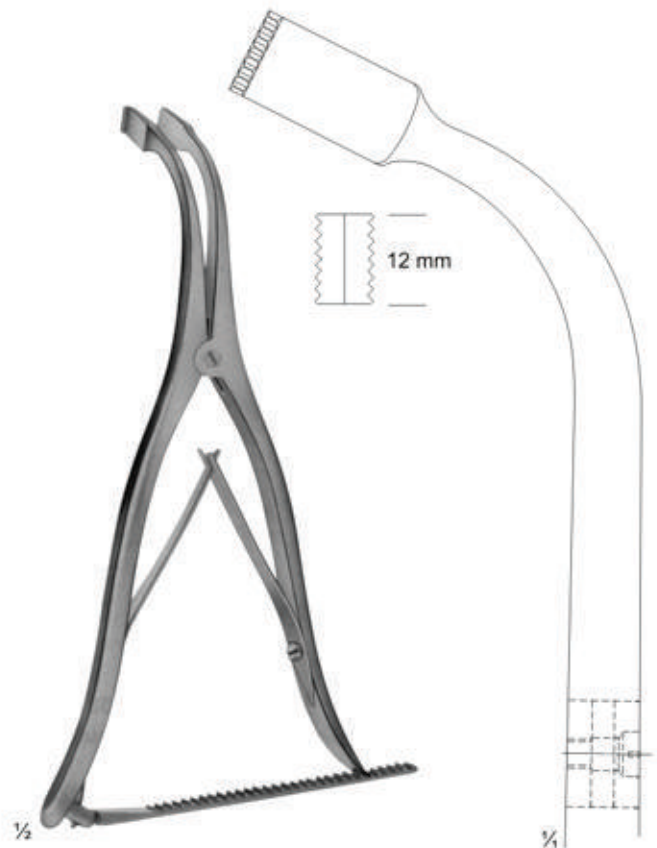

**03-5419**  
INGE  
275 mm



# Abdominal Retractors

Splenor Surgicals



03-5420  
BABY-COLLIN  
with 2 pair of blades



03-5421  
COLLIN  
complete



03-5422  
COLLIN  
complete



03-5423  
RICARD  
complete  
Spreader only  
Lateral blade  
Center blade



03-5424  
HOLZBACH  
Complete  
Spreader only  
Lateral blade 59x80mm  
Center blade 74x82mm



# Abdominal Baldes

*Splenor Surgicals*



03-5427

Lateral blades only  
03-5425 37x62 mm  
03-5426 37x80 mm  
03-5427 37x98 mm

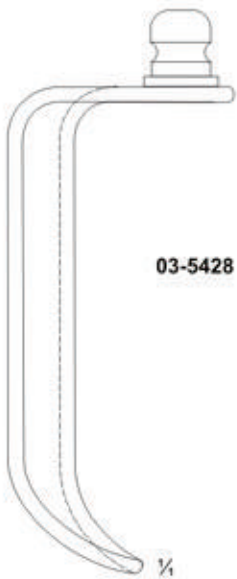

03-5428

03-5428 61x80 mm

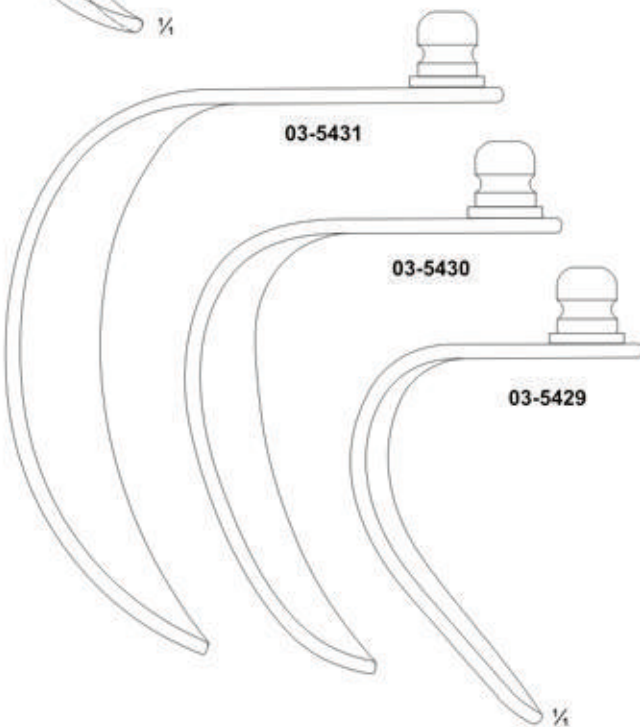

03-5431

03-5430

03-5429

03-5429 48x59 mm  
03-5430 58x80 mm  
03-5431 72x84 mm



03-5432 59x80 mm





# Abdominal Retractors

Splenor Surgicals



03-5433  
GOSSET  
Blades: 38 mm deep

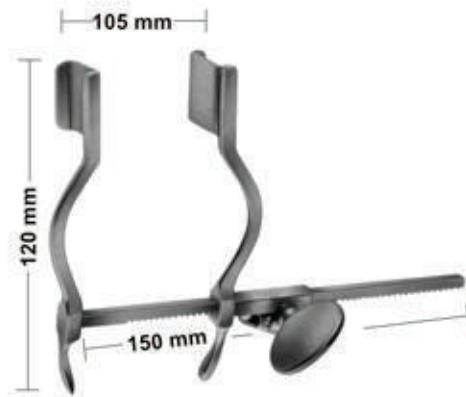

03-5434  
HERTZLER  
Blades 20 X 25 mm

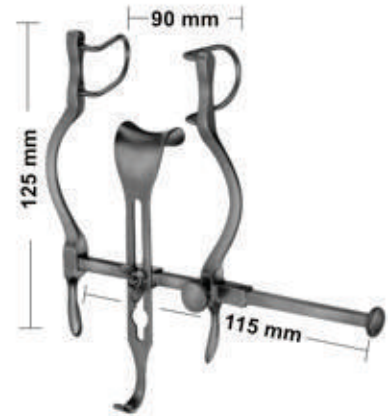

03-5435  
BALFOUR-BABY  
Lateral blades 27 mm deep  
(03-5435) Center blade 21x24 mm

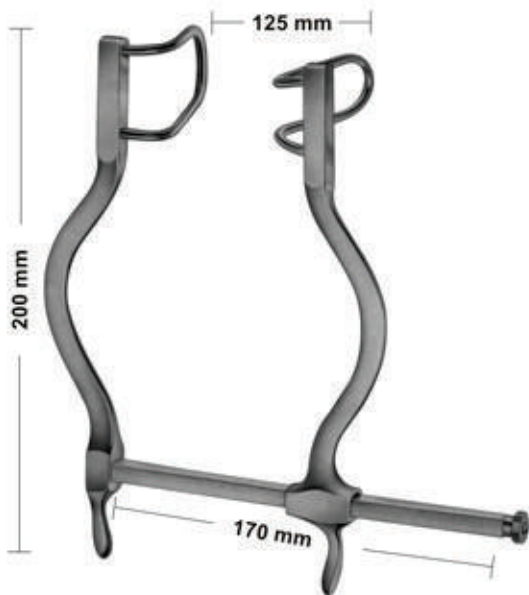

03-5436  
GOSSET  
Blades: 55mm deep

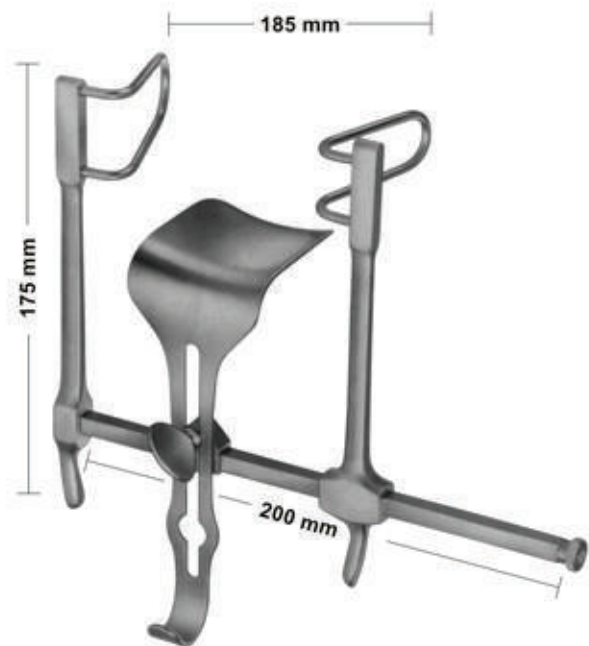

03-5437  
GOSSET  
Lateral blades 58 mm deep  
Center blade  
59 x 57 mm



# Abdominal Retractors

*Splenor Surgicals*

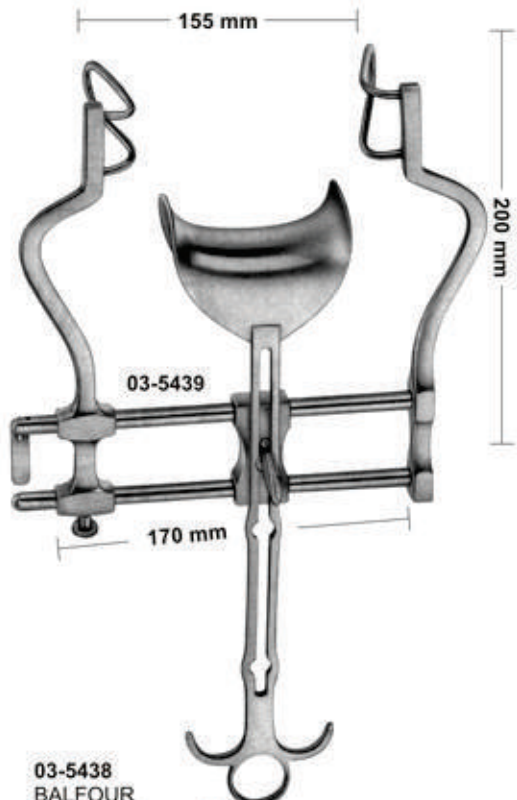

**03-5438**  
BALFOUR  
Lateral blades 60 mm deep  
(03-5439) Center blade  
47 x 80 mm

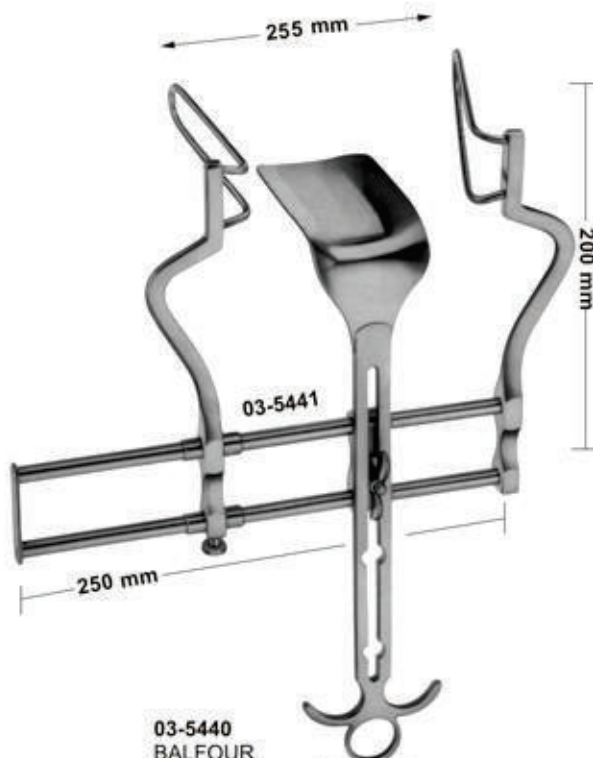

**03-5440**  
BALFOUR  
Lateral blades 105 mm deep  
(03-5441) Center blade  
107x 59 mm



**03-5442**  
Center blade only  
54x80 mm

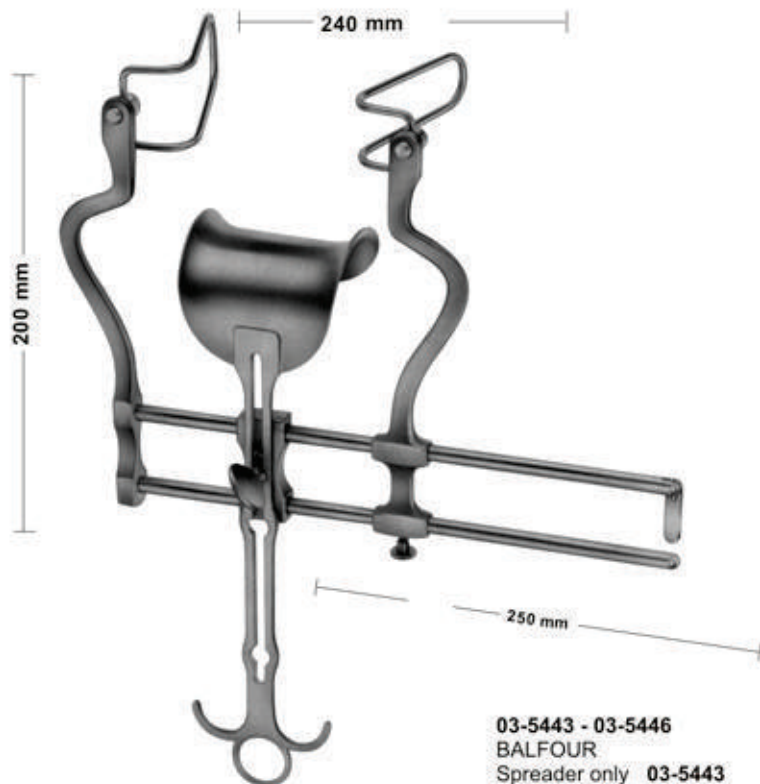

**03-5443 - 03-5446**  
BALFOUR  
Spreader only  
Lateral blades  
Center blade

<b>03-5443</b>	<b>03-5444</b>	<b>03-5445</b>	<b>03-5446</b>
50 mm	60 mm	75 mm	90 mm
47 x 80 mm	62x76 mm	80x80 mm	80x80 mm



Sales Unit of blades: PR = pair

Lateral blades:  
**03-5447**  
50 mm deep  
**03-5448**  
60 mm deep  
**03-5449**  
75 mm deep  
**03-5450**  
90 mm deep

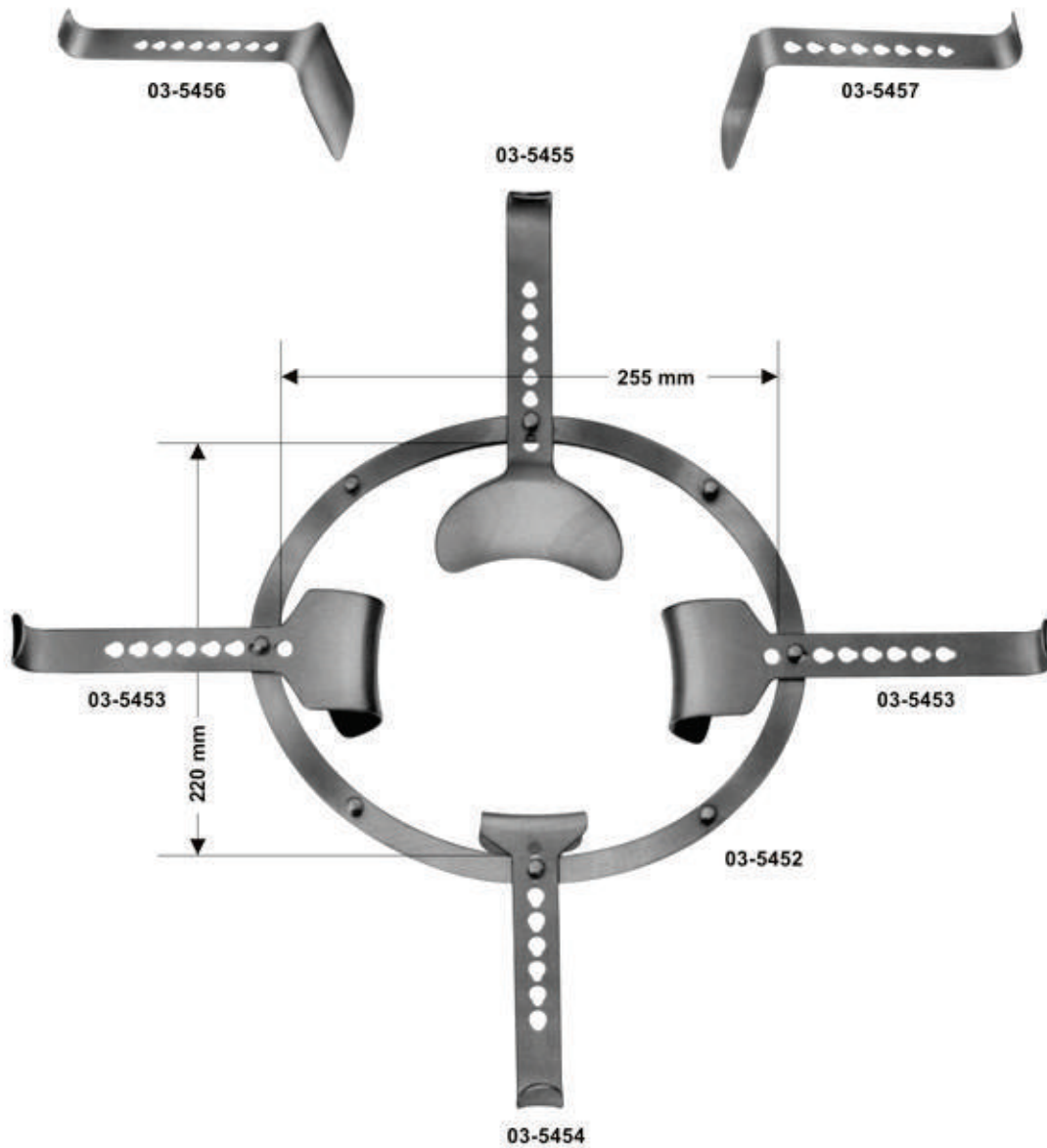

**03-5451**  
SEMM

consisting of:

**03-5452** 1 frame 225 x 220 mm

**03-5453** 2 blades 46 x 64 mm

**03-5454** 1 blade 53 x 54 mm  
(for bladder)

**03-5455** 1 blade 82 x 97 mm  
(for intestine)

**03-5456** 1 blade 98 x 51 mm  
(for intestine)

**03-5457** 1 blade, narrow  
107 x 36 mm



# Abdominal Retractors

Splenor Surgicals

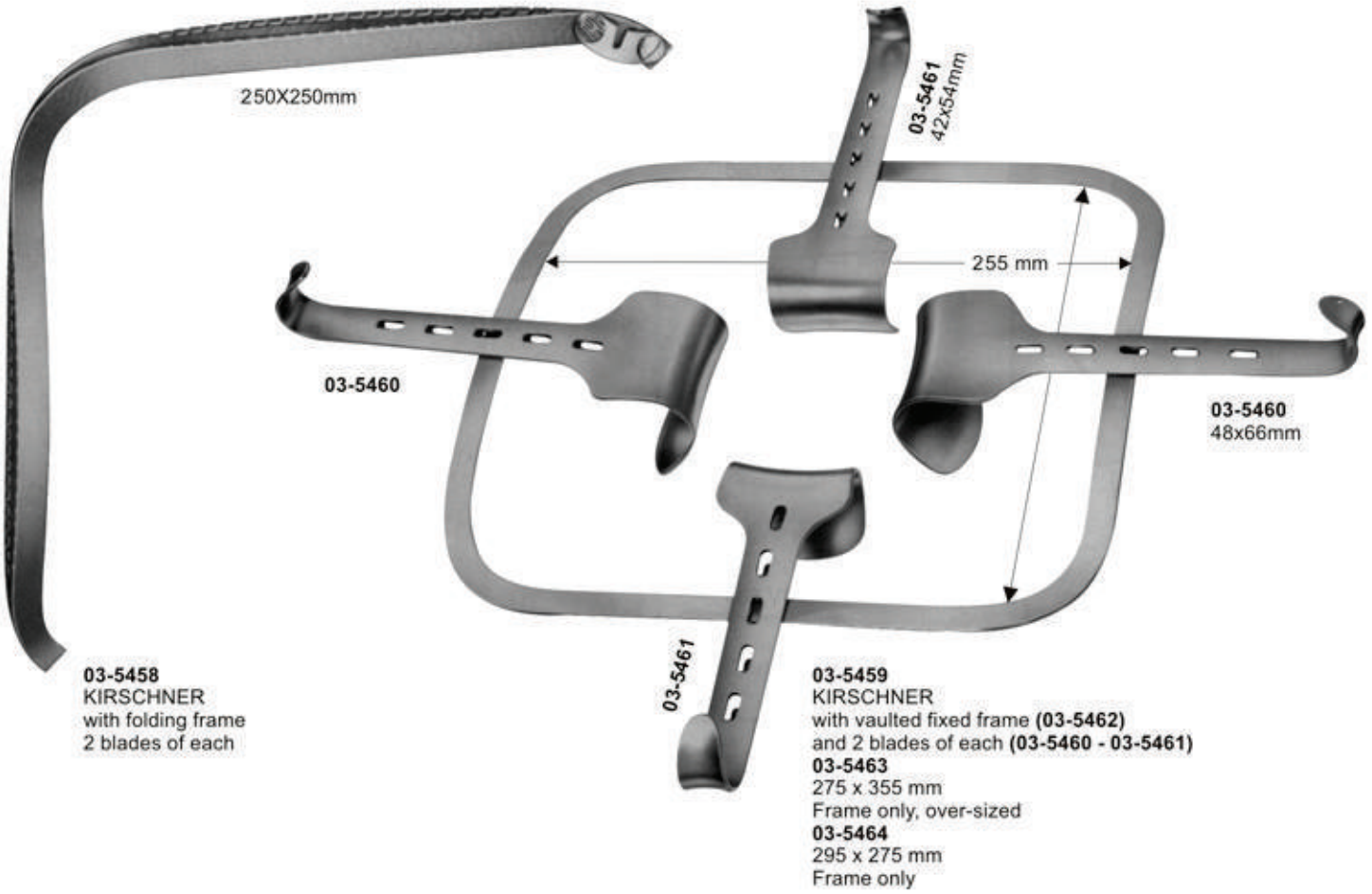

**03-5458**  
KIRSCHNER  
with folding frame  
2 blades of each

250X250mm

03-5460

03-5461  
42x54mm

255 mm

03-5460  
48x66mm

03-5461

**03-5459**  
KIRSCHNER  
with vaulted fixed frame (03-5462)  
and 2 blades of each (03-5460 - 03-5461)  
**03-5463**  
275 x 355 mm  
Frame only, over-sized  
**03-5464**  
295 x 275 mm  
Frame only



**03-5465**  
KIRSCHNER  
64 x 80 mm



**03-5466**  
KIRSCHNER-BALFOUR  
80x 82 mm



**03-5467 - 03-5469**  
KIRSCHNER  
03-5467 90x 69mm  
03-5468 92x 95mm  
03-5469 78x 58mm



**03-5470 - 03-5472**  
KIRSCHNER  
03-5470 108x42mm  
03-5471 91x 55mm  
03-5472 121x 55mm

Addition valves for corpulent persons.

# Needle Holders For Micro Surgery



**02-3832**  
ROHRSCHEIDER  
With copper inserts  
100 mm



**02-3833**  
KALT  
With catch  
135 mm



**02-3834**  
ARRUGA  
With catch  
135 mm



**02-3835 - 02-3836**  
CASTROVIEJO  
With catch  
145 mm



**02-3837 - 02-3838**  
CASTROVIEJO  
With Catch  
160 mm



**02-3839 - 02-3840**  
Without catch  
185 mm



**02-3841 - 02-3842**  
JACOBSON  
185 mm



**02-3843**  
Without catch  
195 mm



**02-3844 - 02-3845**  
YASARGIL  
With catch  
200 mm





# Micro Needle Holders With Round Handles and Bayonet - Shaped

*Splenor Surgicals*

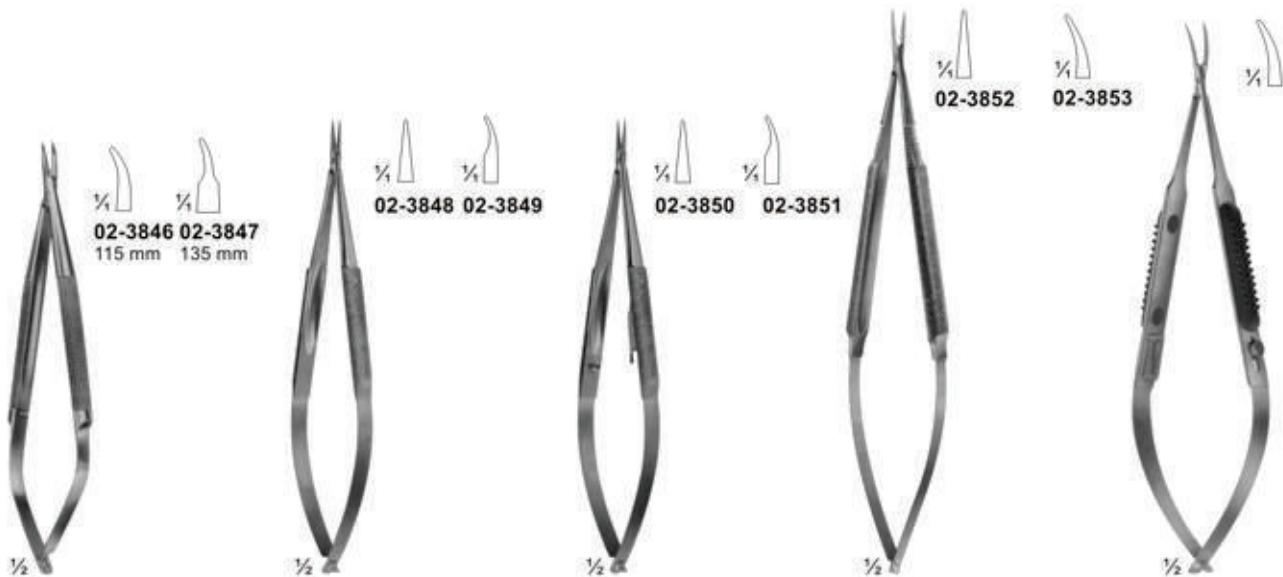

02-3846 02-3847  
115 mm 135 mm

02-3848 02-3849

02-3850 02-3851

02-3852

02-3853

02-3846 - 02-3847  
BARRAQUER  
Without catch

02-3848 - 02-3849  
BARRAQUER  
Without catch  
120 mm

02-3850 - 02-3851  
BARRAQUER  
With catch  
120 mm

02-3852 - 02-3853  
With Catch  
150 mm

02-3854  
MULLER  
With Locking  
Mechanism  
145 mm

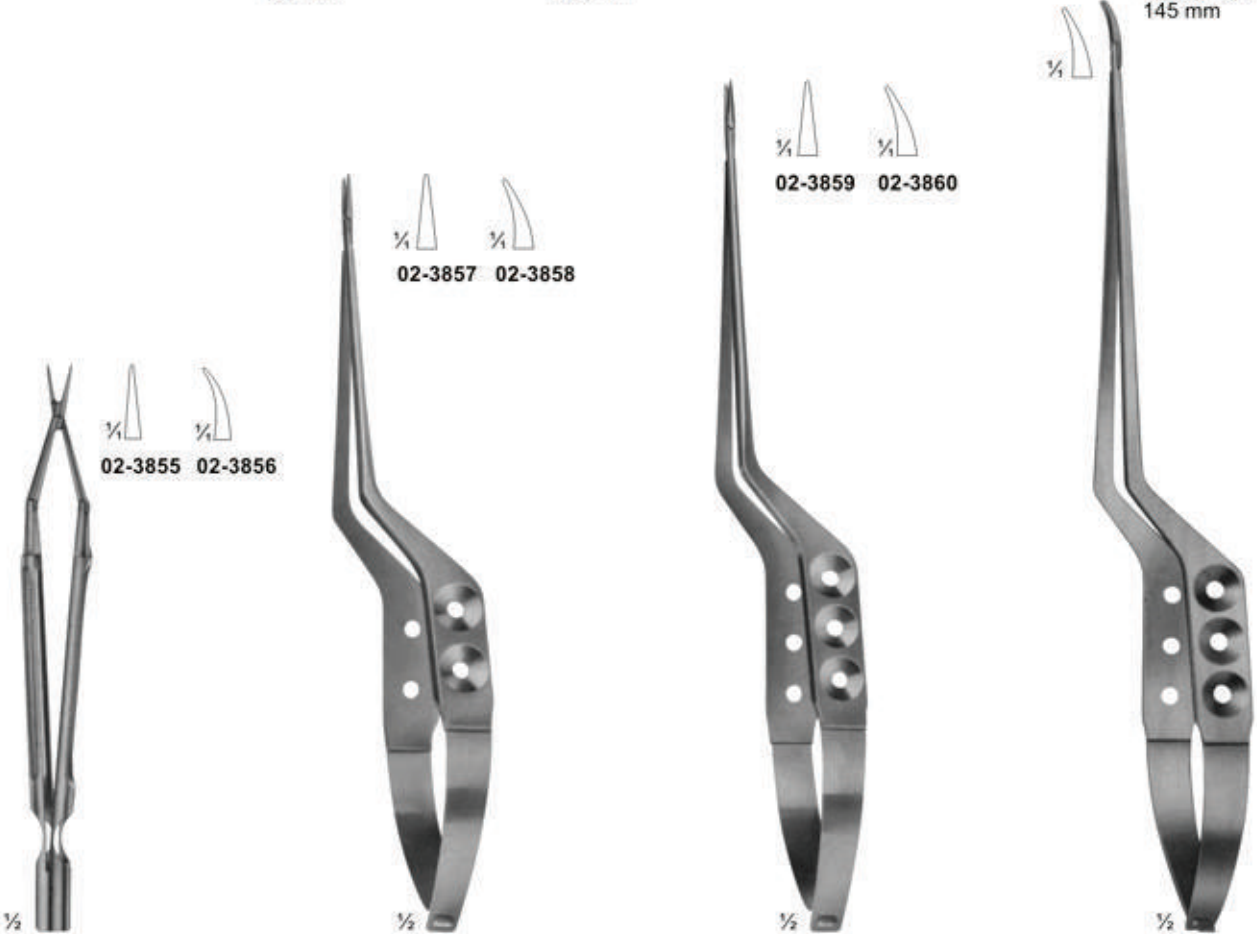

02-3855 02-3856

02-3857 02-3858

02-3859 02-3860

02-3855 - 02-3856  
BROCK  
Without catch  
150 mm

02-3857 - 02-3858  
YASARGIL  
200 mm

02-3859 - 02-3860  
YASARGIL  
225 mm

02-3861  
YASARGIL  
245 mm



# Needle Holders

Splenor Surgicals



02-3862  
CONVERSE  
125 mm



02-3863  
WEBSTER  
125 mm



Smooth jaws



02-3864 - 02-3865  
HALSEY  
130 mm



Smooth jaws



02-3865



02-3866  
DERF  
125 mm



02-3867  
DOYEN  
125 mm



02-3868  
BAUMGARTNER  
145 mm



02-3869  
CRILE-WOOD  
150 mm



Fine Pattern



02-3870  
CRILE-WOOD  
160 mm



Heavy pattern



02-3871  
CRILE-MURRAY  
150 mm



02-3872  
KILNER  
135 mm



02-3873  
ADSON  
175 mm



Designed for Frontal and Palate Suture



# Needle Holders

Splenor Surgicals

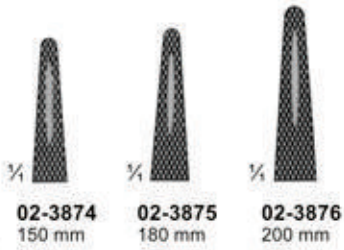

**02-3874 - 02-3876**  
MAYO-HEGAR  
Medium fine patterns

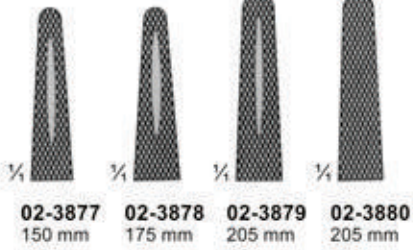

**02-3877 - 02-3880**  
HEGAR  
Heavy Patterns



**02-3881**  
HEANEY (HEGAR)  
200 mm

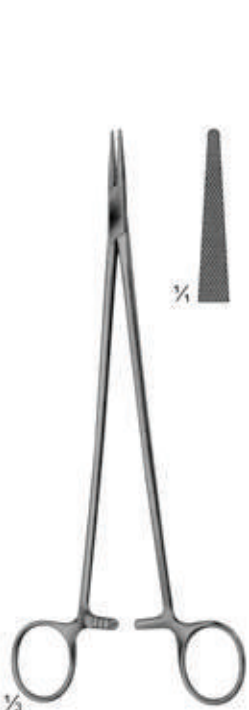

**02-3882**  
JAMESON  
230 mm



**02-3883**  
WANGENSTEEN  
275 mm



**02-3884**  
MASSON  
265 mm

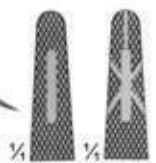
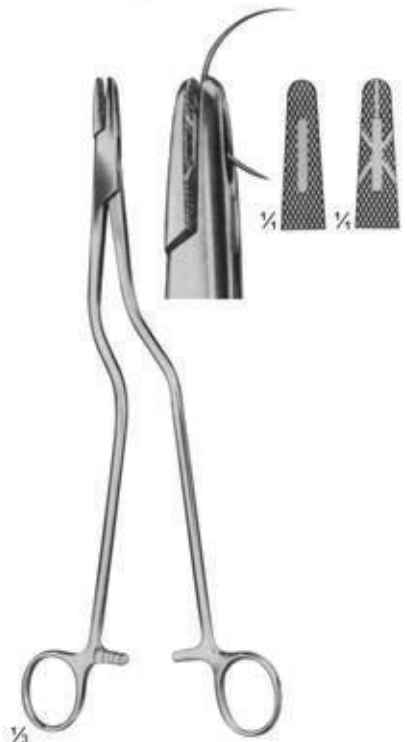

**02-3885**  
MASSON-LUETHY  
255 mm



# Needle Holders

Splenor Surgicals

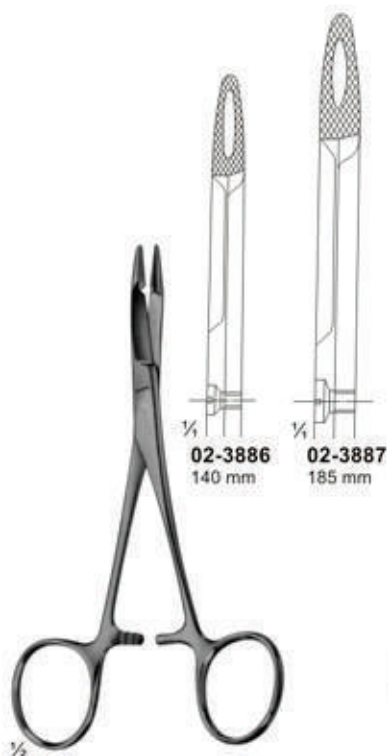

**02-3886 - 02-3887**  
HEGAR-OLSEN  
Needle Holders with Scissors

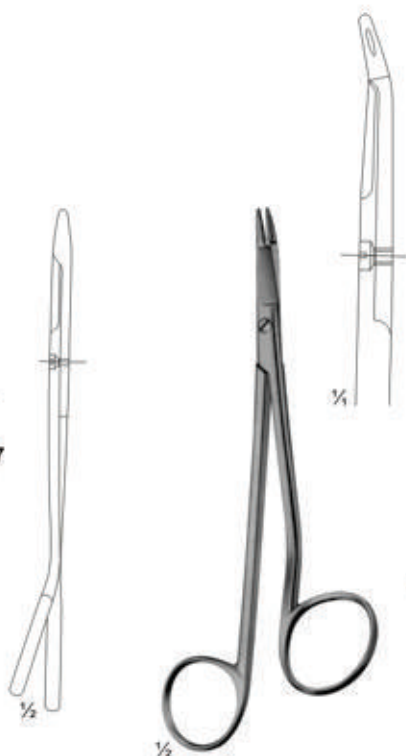

**02-3888**  
GILLIES  
Needle Holders with Scissors  
150 mm



**02-3889**  
GILLIES  
Needle Holders with Scissors  
160 mm

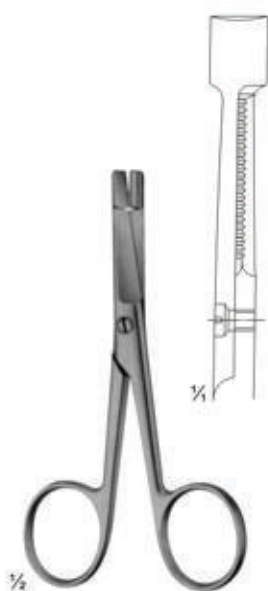

**02-3890**  
EISELSBERG  
Needle Holders with Scissors  
115 mm

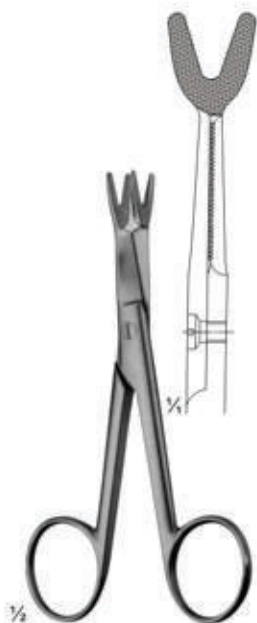

**02-3891**  
SCHOEMAKER-LOTH  
Needle Holders with Scissors  
125 mm



**02-3892**  
CRILE  
150 mm



**02-3893**  
TOENNIS  
Elastic pattern for  
dura-or intestinal suture  
180 mm



# Needle Holders

# Splenor Surgicals

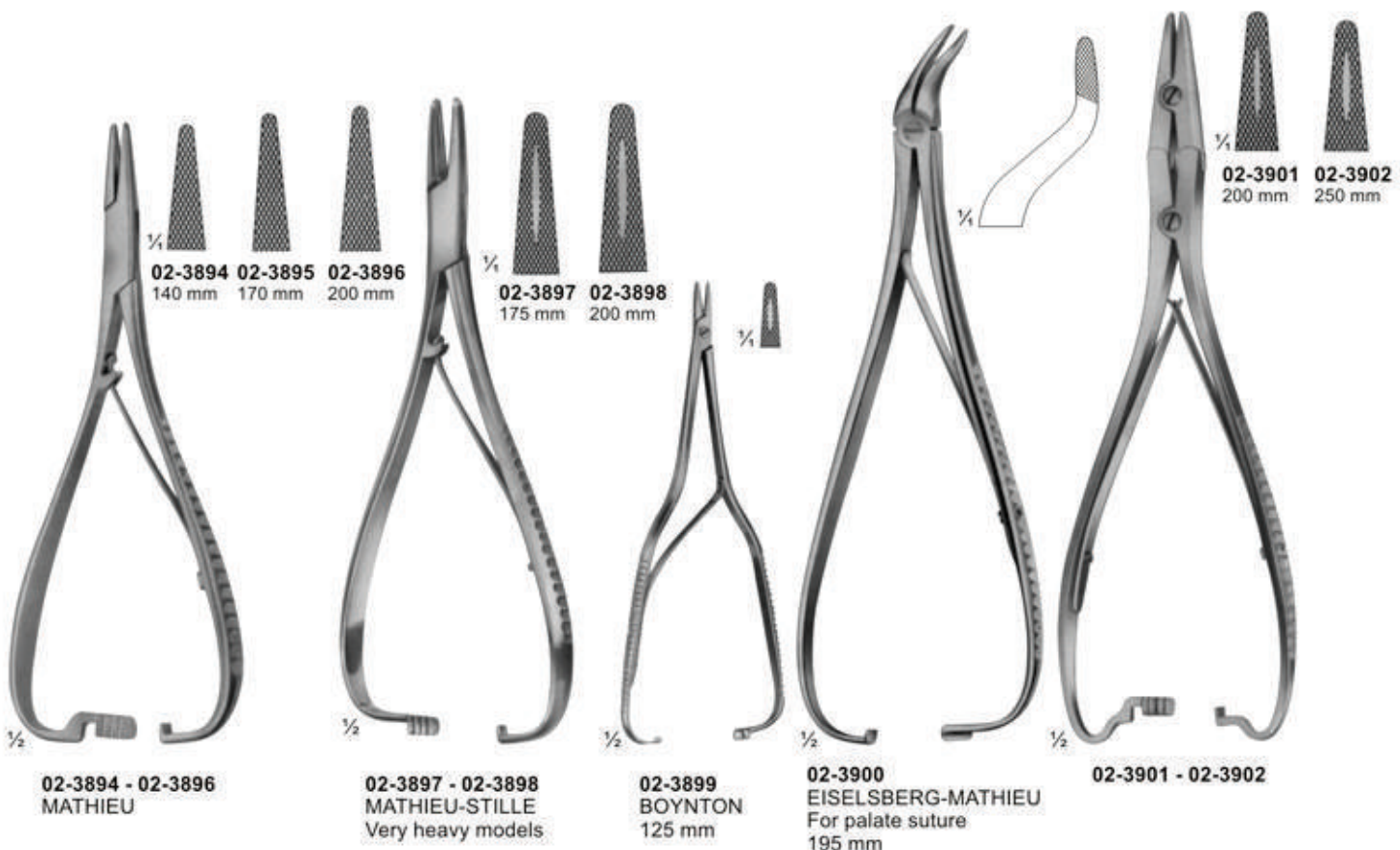

# Spare Needles

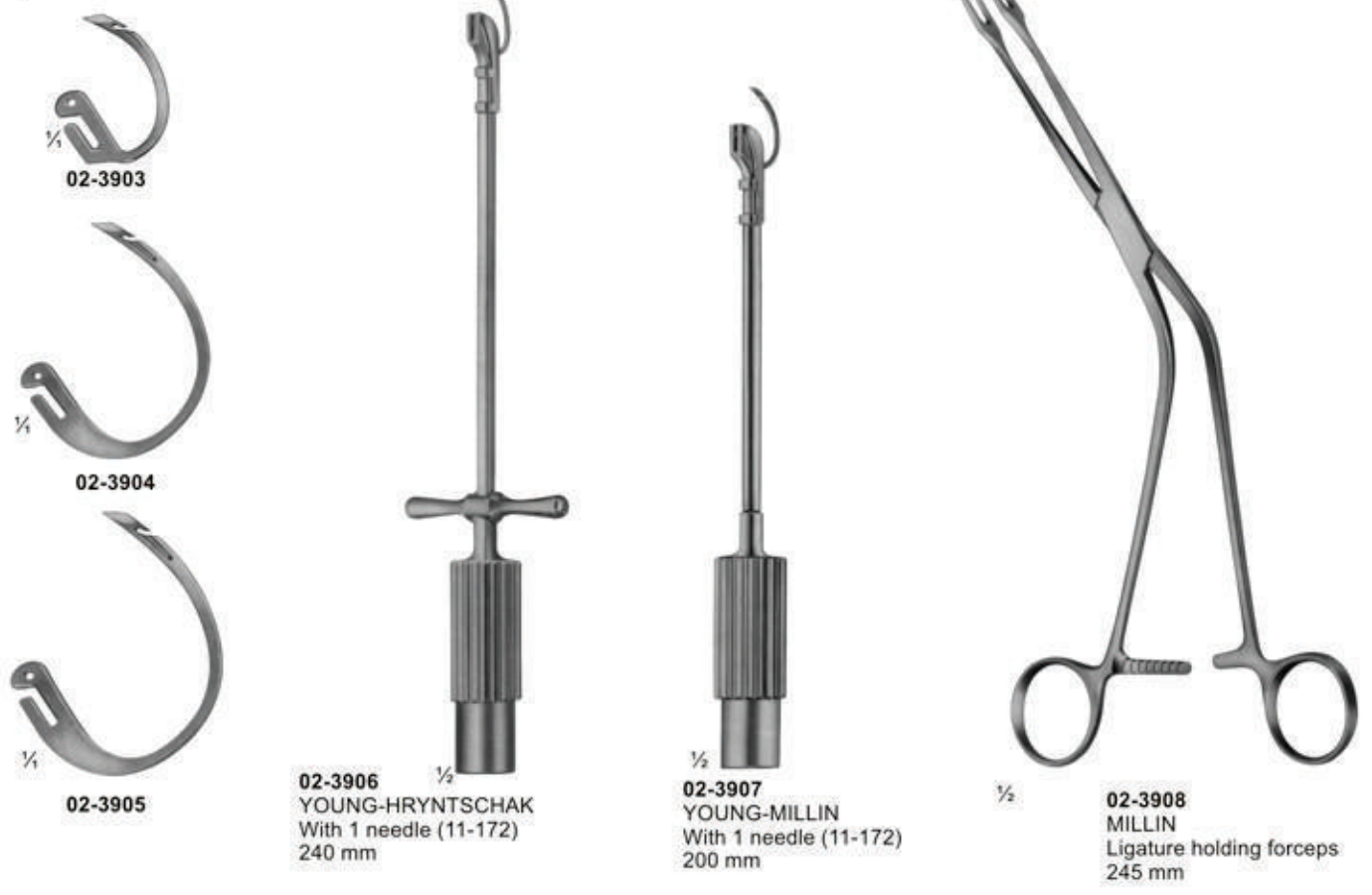



# Suture Instruments - Reverdin Needles

*Splenor Surgicals*



02-3909 - 02-3912  
REVERDIN  
140 mm

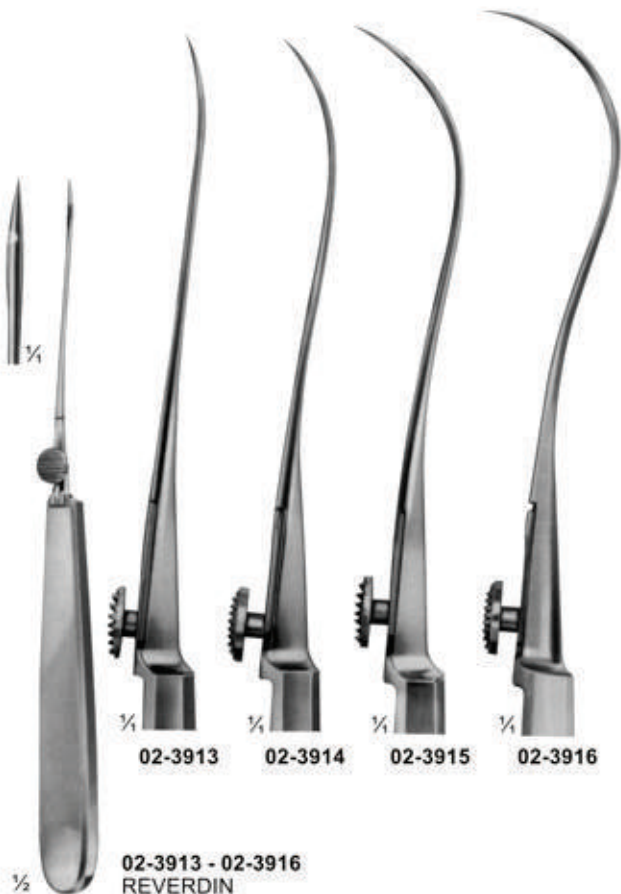

02-3913 - 02-3916  
REVERDIN  
195 mm



02-3917 - 02-3920  
REVERDIN  
220 mm

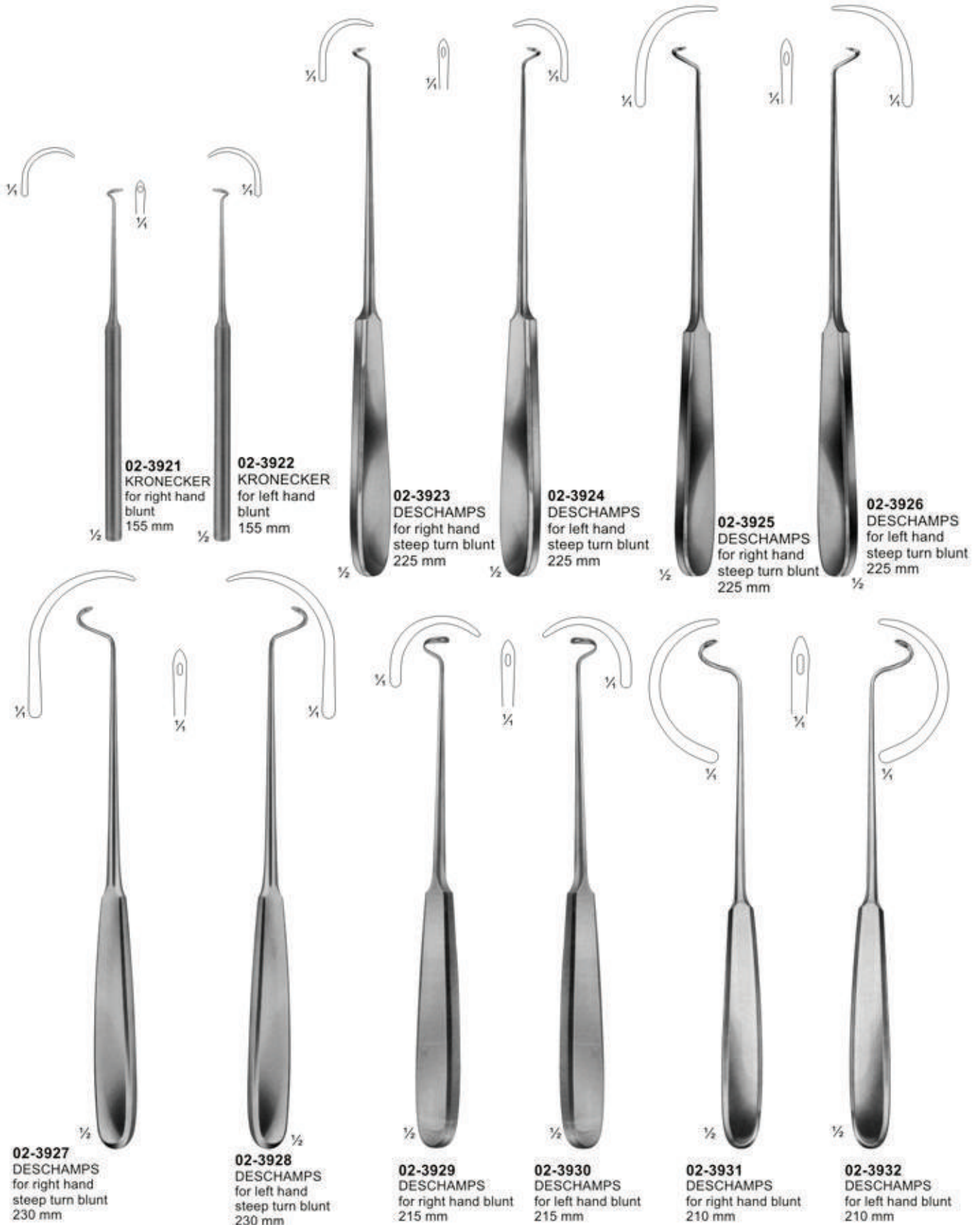



# Suture Instruments - Ligature Needles

*Splenor Surgicals*



1/2  
**02-3933**  
HURD  
for right hand  
sharp  
210 mm



1/2  
**02-3934**  
HURD  
for left hand  
sharp  
210 mm



1/2  
**02-3935**  
DESCHAMPS  
for right hand  
sharp  
215 mm



1/2  
**02-3936**  
DESCHAMPS  
for left hand  
sharp  
215 mm



1/2  
**02-3937**  
JONESCO  
Needle for wire suture  
185 mm



1/2  
**02-3938**  
CLAUS VAN EICKEN  
Needle for wire suture  
250 mm



1/2  
**02-3939**  
150 mm



1/2  
**02-3940**  
SYME  
170 mm



1/2  
**02-3941**  
COOPER  
205 mm



1/2  
**02-3942**  
KOCHER  
205 mm





# Ligature Needles

*Splenor Surgicals*



**02-3943**  
BRUNNER  
240 mm

**02-3944**  
SCHMIEDEN-DICK  
Malleable / Flexible  
320 mm

**02-3945 - 02-3946**  
BRUNNER  
Guiding Probes  
300 mm

**02-3948**

**02-3947**

**02-3945**

**02-3946**



1/4

1/2

1/2



# Guiding Probes and Suture Instruments

*Splenor Surgicals*

4.5 mm



**02-3949**  
KOENIG  
195 mm

7 mm



**02-3950**  
KOENIG  
200 mm

8 mm



**02-3951**  
SCHMIEDEN  
185 mm

11 mm



**02-3952**  
KOCHER  
150 mm

12 mm



**02-3953**  
KOCHER  
170 mm

5 mm



**02-3954**  
PAYR  
195 mm

5 mm



**02-3955**  
PAYR 225 mm



**02-3956**  
280 mm

4 mm



**02-3957**  
KIRSCHNER  
255 mm

4.5 mm



**02-3958**  
BRUNNER  
245 mm

8 mm



**02-3959**  
Knot tier and  
ligature Adjuster  
230 mm



**02-3960**  
CASPAR  
Knot tier and  
ligature Adjuster  
230 mm



**02-3961**  
WIENER MODELL  
Suture hook  
235 mm



# Directors and Probes

# Splenor Surgicals



**02-3962 - 02-3964**  
02-3962 130 mm  
02-3963 145 mm  
02-3964 160 mm  
Directors



**02-3965**  
DOYEN  
145 mm  
Directors



**02-3966**  
NELATON  
160 mm  
Directors



**02-3967**  
Director with tip  
Diam. Of tip 3,3 mm  
140 mm



**02-3968**  
BRODIE  
Director with tip,  
Diam. Of tip 3,5 mm  
200 mm



**02-3969**  
LOCKHART-MUMMERY  
165 mm  
Straight



**02-3970**  
LOCKHART-MUMMERY  
165 mm  
45° Curved

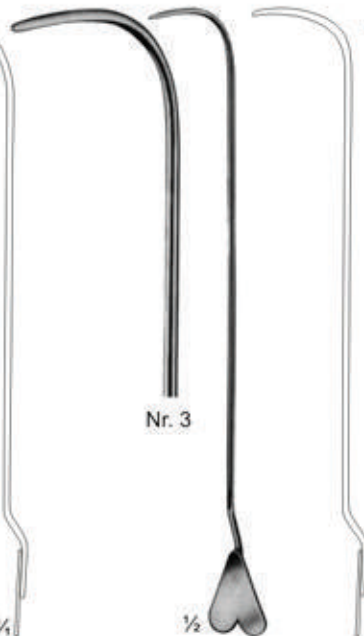

**02-3971**  
LOCKHART-MUMMERY  
165 mm  
90° Curved

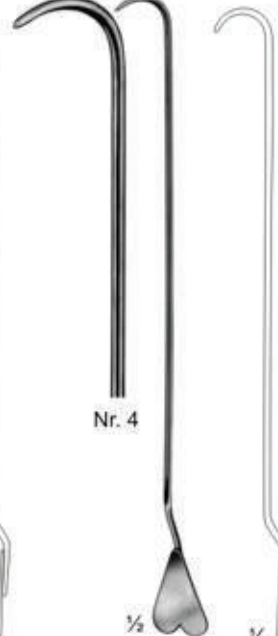

**02-3972**  
LOCKHART-MUMMERY  
165 mm  
Retrograde Curved



**02-3973**  
Director with wire  
loop, malleable  
190 mm



# Probes

Splenor Surgicals

02-3974  
2,5 mm  $\varnothing$   
02-3975  
2,5 mm  $\varnothing$   
02-3976  
3,0 mm  $\varnothing$



02-3974 - 02-3976  
02-3974 145 mm  
02-3975 160 mm  
02-3976 200 mm  
Probes with eye

1,5 mm  $\varnothing$



02-3977  
Myrtle leaf probe  
145 mm

2,0 mm  $\varnothing$



02-3978 - 02-3982  
Myrtle leaf probe  
02-3978 130 mm  
02-3979 145 mm  
02-3980 160 mm  
02-3981 180 mm  
02-3982 200 mm

Diam of tips		Length
1 mm	1,5 mm	2 mm
-	02-3984	140mm
02-3985	02-3986	02-3991
-	02-3987	02-3992
-	02-3988	02-3993
-	02-3989	02-3994
-	02-3990	-
-	-	02-3995

02-3983  
Probes



02-3996  
Double ended probe,  
malleable, diam. of tips  
3 mm with hole  
190 mm



02-3997  
250mm 300mm  
Double ended probes,  
tin, malleable, diam. of tips  
3,5 mm with hole



02-3998  
Double ended probe,  
tin, malleable,  
diam. of tips 4 mm  
400 mm



$\varnothing$  tip  
02-3999 - 02-4001  
02-3999 1,5 mm  
02-4000 2,0 mm  
02-4001 2,5 mm  
300 mm Probes.



# Probes - Spatulas - Cotton Applicators

## Splenor Surgicals

**02-4002**  
STACKE  
Silver  
100 mm  
∅ 0.8mm

**02-4003**  
KILLIAN  
165 mm  
∅ 1.5mm

**02-4004**  
160 mm  
∅ 1.4mm

**02-4005**  
SEIFFERT  
Silver  
180 mm  
∅ 0.5mm

**02-4006**  
BOWMAN  
130 mm  
German Silver

**02-4007 - 02-4011**  
**02-4007** 0.7+0.8mm ∅ Fig. 00/0  
**02-4008** 0.9+1.1mm ∅ Fig. 1/2  
**02-4009** 1.3+1.4mm ∅ Fig. 3/4  
**02-4010** 1.5+1.6mm ∅ Fig. 5/6  
**02-4011** 1.8+1.9mm ∅ Fig. 7/8

**02-4012**  
SPATULA  
145 mm

**02-4013**  
SPATULA  
145 mm

**02-4014**  
Modell PICCOLO  
Round Serrated end  
110 mm 0.7mm

**02-4015**  
Modell PICCOLO  
Triangular Serrated end  
110 mm 0.7mm











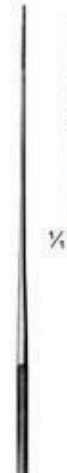

**02-4016**  
FARRELL  
Round Serrated end  
110 mm 1.2mm

**02-4017**  
LATHBURY-FARRELL  
Triangular Serrated end  
110 mm 1.4mm



# Cotton Applicators

Splenor Surgicals

 <p><b>02-4018</b> BUCK Rough, spiral end ∅120 mm 0.9mm</p>	 <p><b>02-4019</b> Triangular serrated end ∅140 mm 0.9mm</p>	 <p><b>02-4020</b> Rough, spiral end ∅140 mm 1.0mm</p>	 <p><b>02-4021</b> Rough, spiral end ∅140 mm 1.2mm</p>	 <p><b>02-4022</b> Rough, spiral end ∅140 mm 1.8mm</p>	 <p><b>02-4023</b> FARRELL Round, serrated end ∅140 mm 1.2mm</p>	 <p><b>02-4024</b> LATHBURY-FARRELL Triangular, serrated end 140 mm ∅1.4mm</p>
 <p><b>02-4025</b> FARRELL Rough, spiral end ∅160 mm 1.2mm</p>	 <p><b>02-4026</b> LATHBURY-FARRELL Triangular, serrated end 160 mm ∅1.2mm</p>	 <p><b>02-4027</b> Triangular, serrated end ∅160 mm 1.4mm</p>	 <p><b>02-4028</b> Rough, spiral end ∅180 mm 1.5mm</p>	 <p><b>02-4029</b> Rough, spiral end ∅180 mm 1.8mm</p>	 <p><b>02-4030</b> Rough, spiral end ∅270 mm 2.5mm</p>	



# Clip Applying Forceps, Clip Applying - and Removing Forceps



02-4031  
MICHEL  
125 mm



02-4032  
HEGENBARTH  
120 mm



02-4033  
WACHENFELDT  
120 mm



02-4034  
WACHENFELDT  
120 mm



02-4035  
MICHEL  
125 mm



02-4036  
MICHEL modif.  
130 mm



02-4037  
HEATH  
135 mm



02-4038  
COLLIN  
135 mm



# Suturing Instrument Set, Pocket Instrument Set



**02-4039**

Suturing instruments set, in metal case consisting of:  
 1 michel clip applying and removing forceps,  
 1 Scissors, curved, sharp/sharp, 115mm  
 25 MICHEL clips, 16 x 3mm 1Delicate tissue forceps, 130mm  
 1 Scalpel, bellied 1 MATHIEU needle holder, 140mm  
 1 Perforated metal case, stainless  
 containing:  
 1 Suture needle  
 1 Suture needle  
 1 Suture needle



**02-4040**

Pocket instrument set, in metal case consisting of:

**Bottom tray**

1 MATHIEU needle holder, 140mm  
 1 MICHEL clip forceps, combined  
 1 Myrtle leaf probe, 130mm  
 1 Sharp double curette  
 1 Skin hook  
 1 Detachable scalpel handle, no.4  
 1 Perforated metal case, containing  
 6 Scalpel blades  
 1 Perforated metal case, stainless, containing  
 1 Suture needle  
 1 Suture needle  
 1 Suture needle

**Top tray**

1 Tissue forceps, 130mm  
 1 KOCHER haemostatic forceps, 130mm  
 1 Straight surgical scissors, 130mm  
 1 Dissecting forceps, 130mm  
 1 FEILCHENFELD splinter forceps, 115mm  
 25 MICHEL clip, 16 x 3mm  
 1 Flacon of suture skin, sterile in alcohol



**02-4041**

Pocket instrument set, in metal case consisting of:

**Bottom tray**

1 MAYO-HEGER needle holder, 150mm  
 1 MICHEL clip forceps, combined 1 Myrtle leaf probe, 130mm  
 1 Sharp double curette 1 Skin hook 1 Detachable scalpel handle, no. 4  
 1 Perforated metal case, consisting  
 6 Scalpel blades  
 1 Perforated metal case, stainless, consisting:  
 1 Suture needle  
 1 Suture needle  
 1 Suture needle

**Top tray**

1 Tissue forceps, 130mm  
 1 CRILE haemostatic forceps, 140mm  
 1 Straight surgical scissors, 130mm  
 1 Dissecting forceps, 130mm  
 1 FEILCHENFELD splinter forceps, 115mm  
 25 MICHEL clip, 16 x 3mm  
 1 Flacon of suture silk, sterile in alcohol





# Pocket Instrument Set, Venae Sectio Set

## Splenor Surgicals

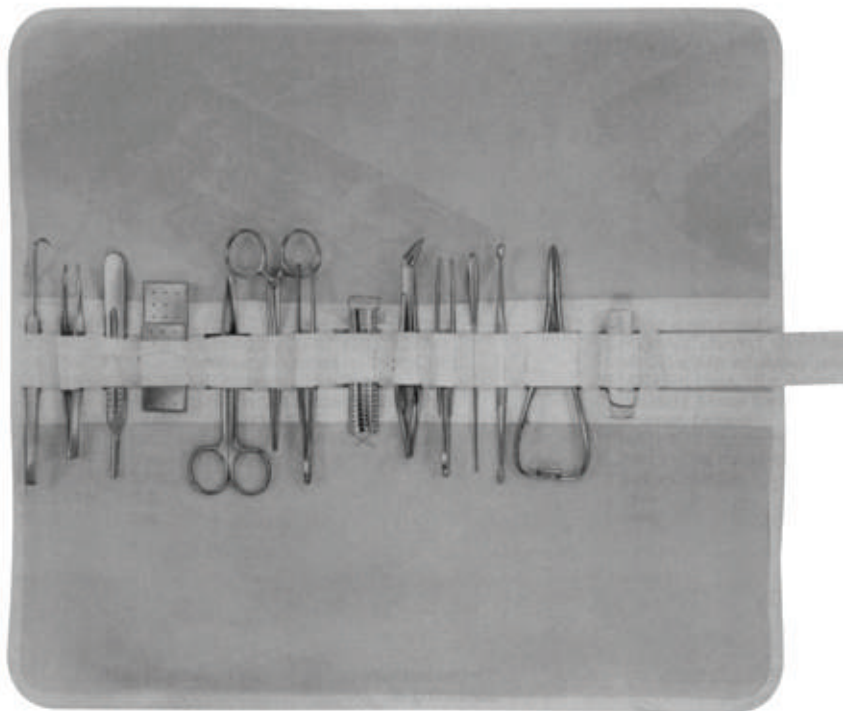

### 02-4042

Pocket instrument set in metal case 170 x 90mm canvas roll only, sterilizable in autoclave.

consisting of:

- 1 Myrtle leaf probe, 130mm
- 1 Sharp double curette
- 1 FEILCHENFELD splinter forceps, 115mm
- 1 Dissecting forceps, 130mm
- 1 Tissue forceps, 130mm

- 1 Straight surgical scissors, 130mm
- 1 Scalpel handle no. 4
- 1 Perforated metal case, consisting of 6 scalpel blades
- 1 KOCHER haemostatic forceps, 130mm
- 1 Skin hook
- 1 MATHIEU needle holder, 140mm
- 1 Tube of suture skin, sterile in alcohol
- 1 MICHEL clip forceps, 120mm

- 25 MICHEL clip, 16 x 3mm
- 1 Perforated metal case, stainless, consisting of:
- 1 Suture needle
- 1 Suture needle
- 1 Suture needle

### 02-4043

Canvas roll only, sterilizable in autoclave

Suitable Metal Cases

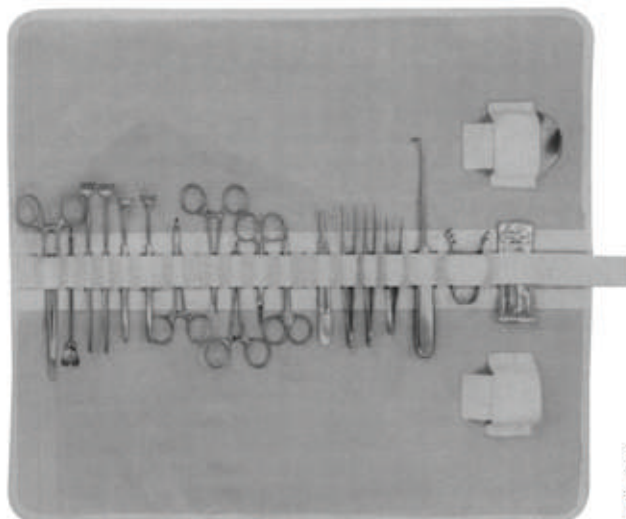

250 x 125 x 55mm



233 x 148 x 57mm

### 02-4044

Venae sectio set, canvas roll only, sterilizable in autoclave.

consisting of:

- 2 Tissue forceps, 1 x 2 teeth, 140mm
- 1 Dissecting forceps, 145mm
- 1 FEILCHENFELD splinter forceps, 115mm
- 1 Straight scissors, sharp, 110mm
- 1 Curved scissors, blunt, 115mm
- 3 HALSTED mosquito forceps, curved on flat, 125mm

- 1 DESCHAMPS needle, blunt, 210mm
- 1 DOYEN Director, curved, 140mm
- 2 Wound retractors, 4 blunt prongs, 160mm
- 2 DESMARRES wound retractors, 135mm
- 1 FINSSEN retractors, 2 x3 blunt prongs, 80mm
- 1 Scalpel handle no. 4
- 4 Sterile scalpel blades, no 18, single peel pack
- 1 Needle box, perforated, round, diam. 65mm
- 1 HEGAR-MAYO DUROGRIP needle holder, 180mm

### 02-4045

Canvas roll only, sterilizable in autoclave

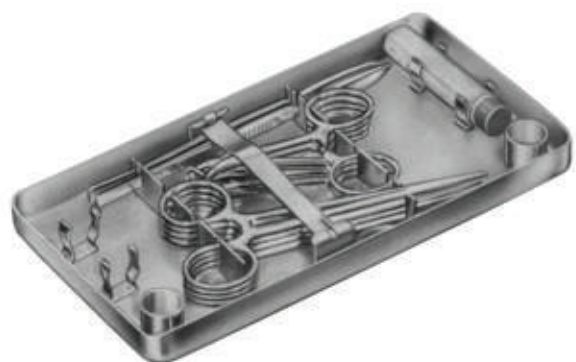

**02-4046**

Venae sectio set, in metal case

consisting of:

**Bottom tray**

- 1 MATHIEU needle holder, fine pattern 140mm
- 1 Ligature needle, fine short pattern
- 1 DOYEN director, curved
- 1 HEGENBARTH clip forceps,
- 1 ELSCHNIG tissue forceps, 1 x 2 teeth fine, 105mm
- 1 Dressing forceps, fine 105mm
- 1 Tissue forceps, 1 x 2 teeth, 110mm
- 1 Vessel scissors, straight, with 1 ball point, 110mm
- 1 Vessel scissors, curved, pointed 105mm
- 1 FINSSEN retractor
- 1 Perforated needle case

**Top tray**

- 1 Scalpel, pointed
- 1 Scalpel, bellied
- 2 HALSTED mosquito forceps, curved, 125mm
- 2 HALSTED mosquito forceps, straight, 1x 2 teeth, 125mm
- 3 BACKHAUS towel forceps, 90mm
- 2 Flacon holder

# Intestinal and Tissue Grasping Forceps



**03-5473**  
**CHAPUT**  
 2 X 3 teeth, sharp  
 125 mm,

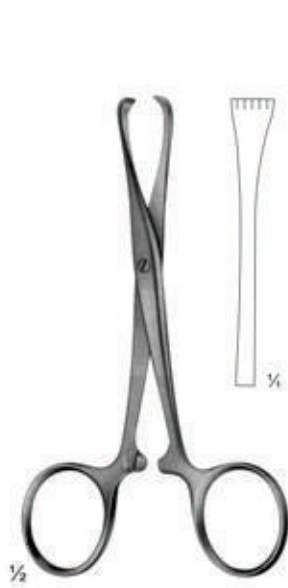

**03-5474**  
**TUFFIER**  
 5 X 6 teeth, sharp  
 125 mm,



**03-5475**  
**BOYS-ALLIS**  
 5 X 6 teeth, sharp  
 155 mm,



**03-5476**  
**BABY-ALLIS**  
 4 X 5 teeth  
 130mm



**03-5477**  
**ALLIS**  
 4 X 5 teeth  
 155 mm,



**03-5478**  
**ALLIS**  
 190 mm,  
**03-5479**  
 255 mm,  
 5 X 6 teeth  
 Slender pattern



**03-5480**  
**JUDD-ALLIS**  
 3 X 4 teeth  
 195 mm,



# Intestinal Grasping Forceps

*Splenor Surgicals*



**03-5481**  
BABCOCK  
155 mm



**03-5482 - 03-5483**  
BABCOCK

**03-5482** 170 mm  
**03-5483** 215 mm



**03-5484**  
BABCOCK  
220 mm



**03-5485**  
COLLIN  
140 mm,

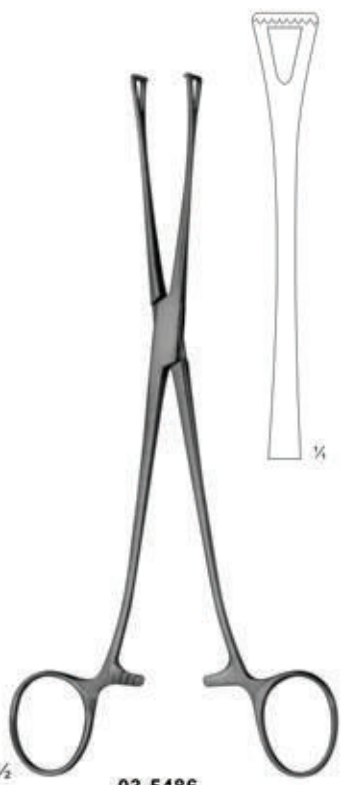

**03-5486**  
LOCKWOOD  
200 mm,



**03-5487**  
DUVAL-COLLIN  
195 mm  
**03-5488**  
200 mm

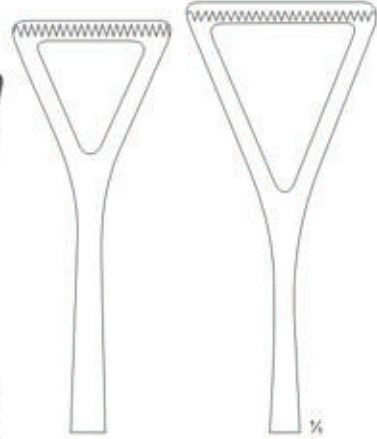

**03-5487**  
195 mm

**03-5488**  
200 mm

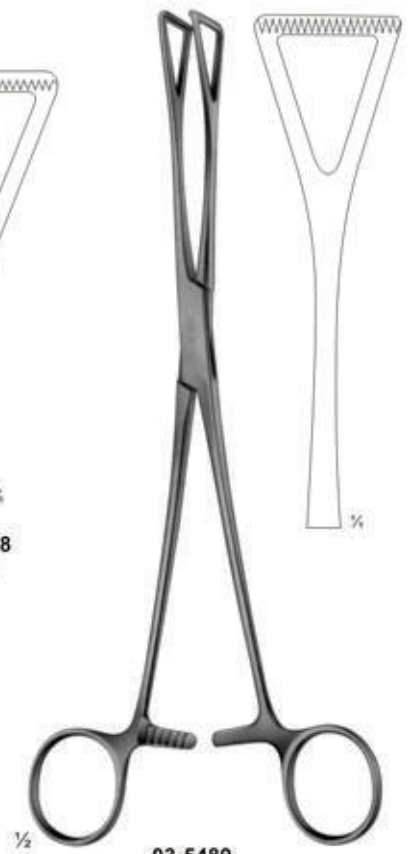

**03-5489**  
DUVAL  
230 mm,



# Organ - Tissue Grasping, Intestinal and Dissecting Forceps

*Splenor Surgicals*



**03-5490** 130 mm  
**03-5491** 155 mm  
**03-5492** 195 mm

**03-5490 - 03-5492**  
LANE

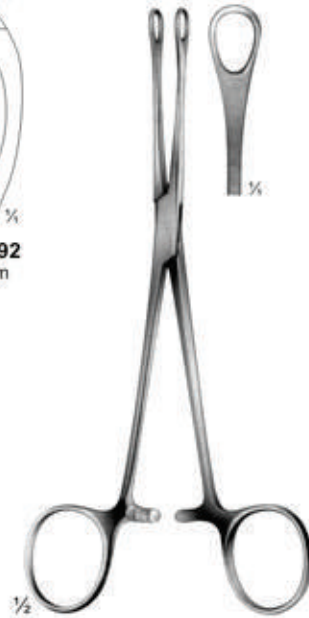

**03-5493**  
WILLIAMS  
160 mm



**03-5494**  
DENIS  
BROWNE  
190 mm



**03-5495**  
DUVAL  
140 mm



**03-5496** **03-5497**  
DUROGRIP

**03-5496 - 03-5497**  
WANGENSTEEN  
**03-5496** 150 mm  
**03-5497** 230 mm

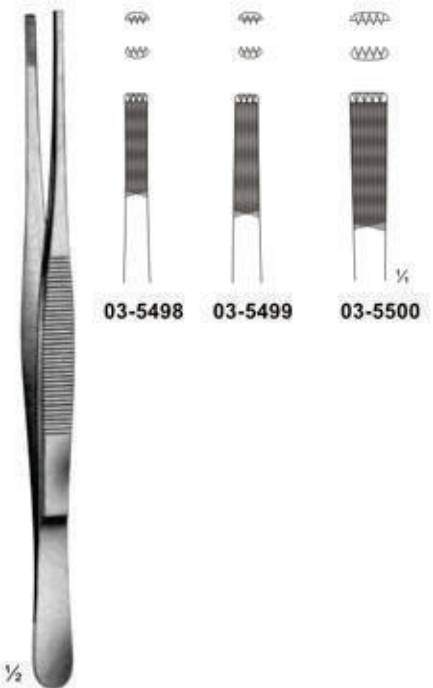

**03-5498 - 03-5500**  
STILLE-BARRAYA  
**03-5498** 180mm  
**03-5499** 200mm  
**03-5500** 250mm



# Organ - Tissue Grasping & Intestinal Forceps ATRAUMATA

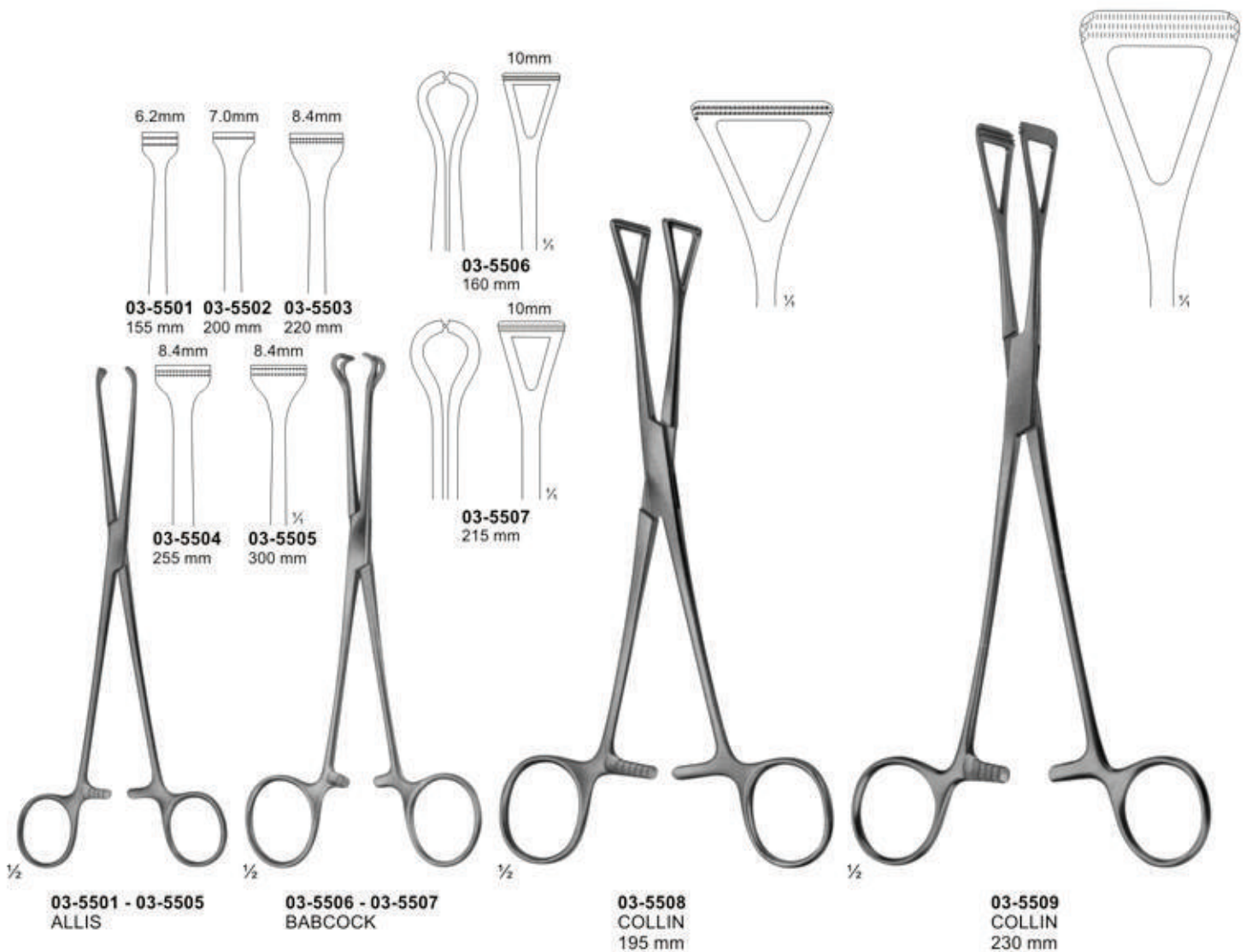



# Ultra - Light - Forceps, Dissecting Forceps ATRAUMATA

*Splenor Surgicals*



**03-5510** 1,2 mm  
**03-5511** 1,5 mm  
**03-5512** 1,5 mm  
**03-5513** 1,5 mm

- 03-5510 - 03-5513**  
**03-5510** 150 mm  
**03-5511** 200 mm  
**03-5512** 240 mm  
**03-5513** 300 mm



**03-5514** 2 mm  
**03-5515** 2 mm  
**03-5516** 2 mm  
**03-5517** 2 mm

- 03-5514 - 03-5517**  
**DE BAKEY**  
**03-5514** 150 mm  
**03-5515** 200 mm  
**03-5516** 240 mm  
**03-5517** 300 mm

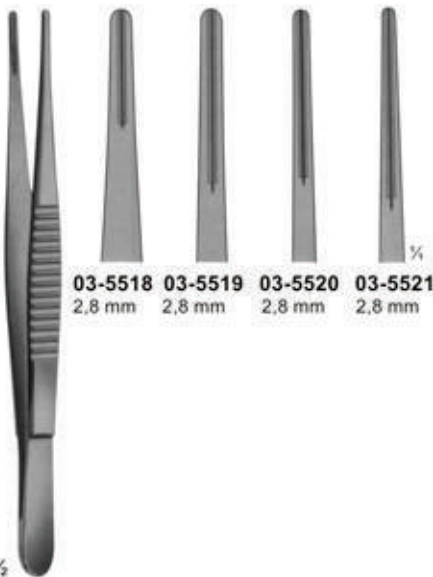

**03-5518** 2,8 mm  
**03-5519** 2,8 mm  
**03-5520** 2,8 mm  
**03-5521** 2,8 mm

- 03-5518 - 03-5521**  
**DE BAKEY**  
**03-5518** 150 mm  
**03-5519** 200 mm  
**03-5520** 240 mm  
**03-5521** 300 mm

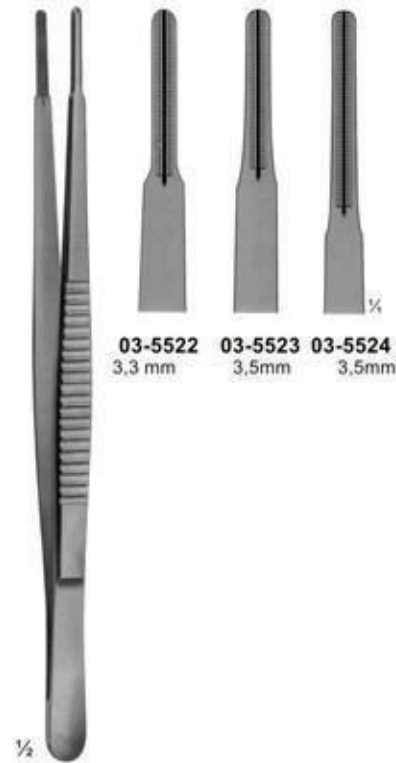

**03-5522** 3,3 mm  
**03-5523** 3,5 mm  
**03-5524** 3,5 mm

- 03-5522 - 03-5524**  
**DE BAKEY**  
**03-5522** 200 mm  
**03-5523** 240 mm  
**03-5524** 300 mm



# Intestinal Clamps for Children

*Splenor Surgicals*



**03-5525 - 03-5526**  
BAINBRIDGE  
155 mm



**03-5527**  
ALLEN  
155 mm

## Atraumata



**03-5528 - 03-5529**  
BABY-KOCHER  
very elastic blades  
130 mm



**03-5530 - 03-5531**  
BABY-KOCHER  
with elastic blades  
130 mm



# Intestinal Clamps, Soft Elastic



**03-5532 - 03-5533**  
DOYEN  
elastic  
165 mm



**03-5534 - 03-5535**  
DOYEN  
with elastic blades  
170 mm



**03-5536 - 03-5537**  
HARTMANN  
with elastic blades  
200 mm



**03-5538 - 03-5539**  
HARTMANN  
with elastic blades  
200 mm



# Intestinal Clamps, Soft elastic

*Splenor Surgicals*

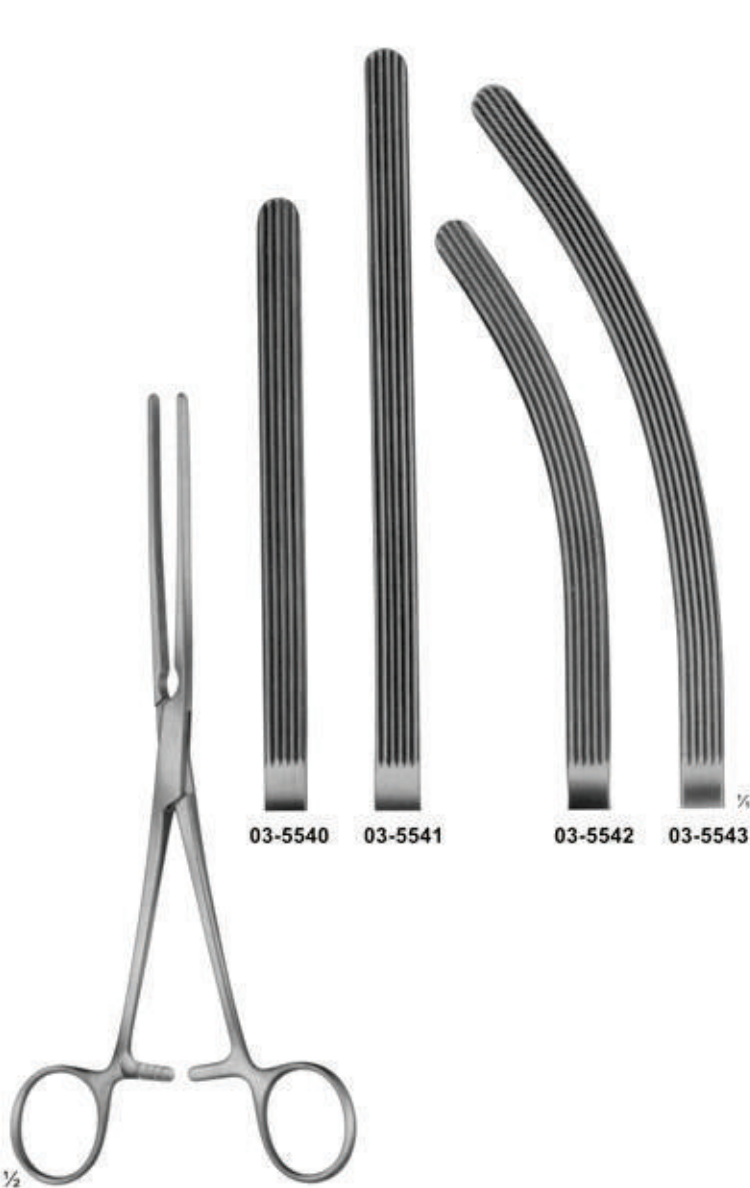

03-5540    03-5541    03-5542    03-5543

**03-5540 - 03-5543**  
KOCHER  
with elastic blades  
**03-5540-03-5542**    210 mm  
**03-5541-03-5543**    230 mm



03-5544    03-5545

**03-5544 - 03-5545**  
DOYEN  
with elastic blades  
240 mm



# Intestinal Clamps, Soft elastic

*Splenor Surgicals*





# Intestinal Clamps, Soft elastic

*Splenor Surgicals*

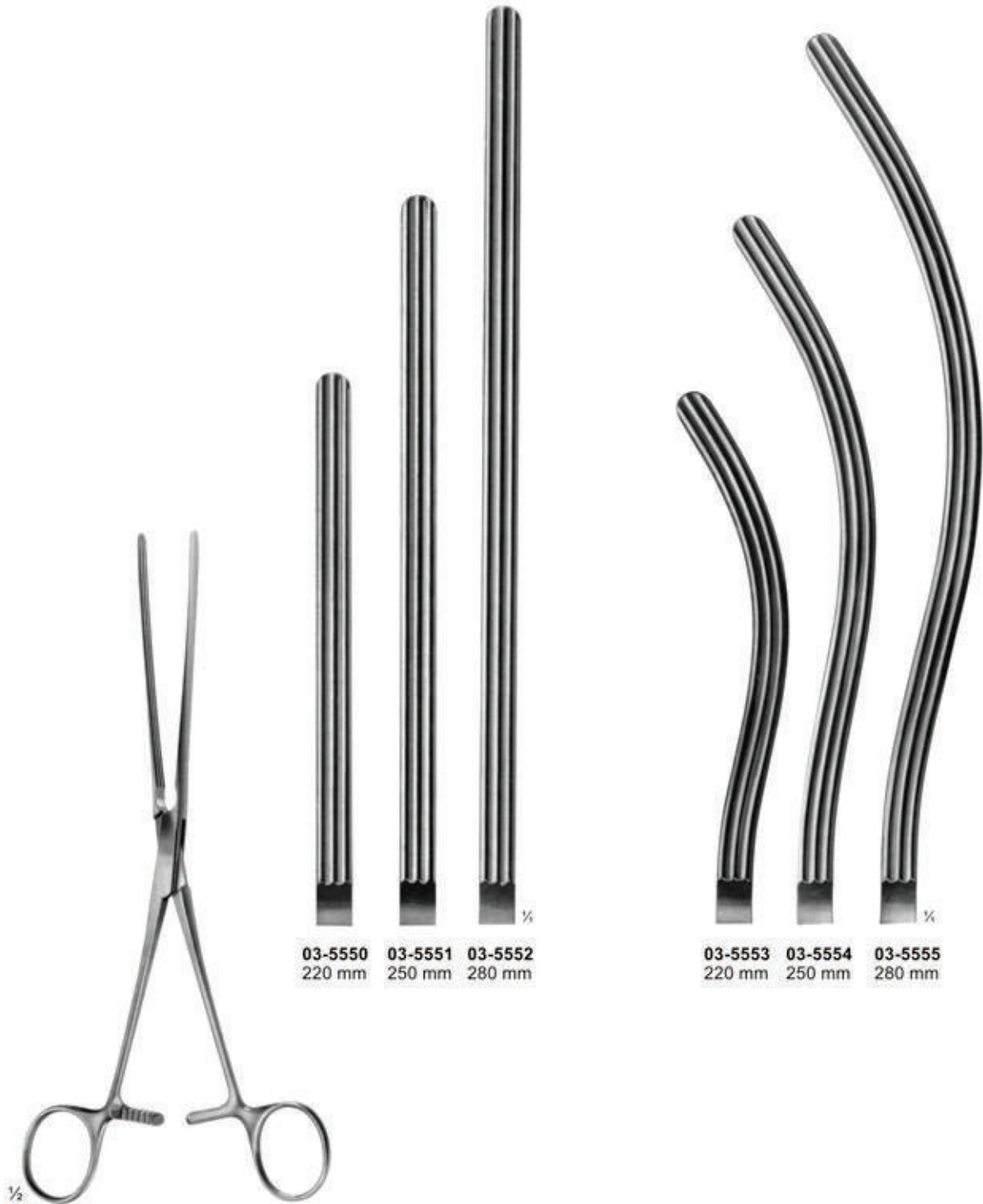

03-5550 - 03-5555  
KOCHER  
with very elastic blades

03-5550 220 mm  
03-5551 250 mm  
03-5552 280 mm

03-5553 220 mm  
03-5554 250 mm  
03-5555 280 mm



# Intestinal Clamps, Soft elastic

*Splenor Surgicals*

## Atraumata

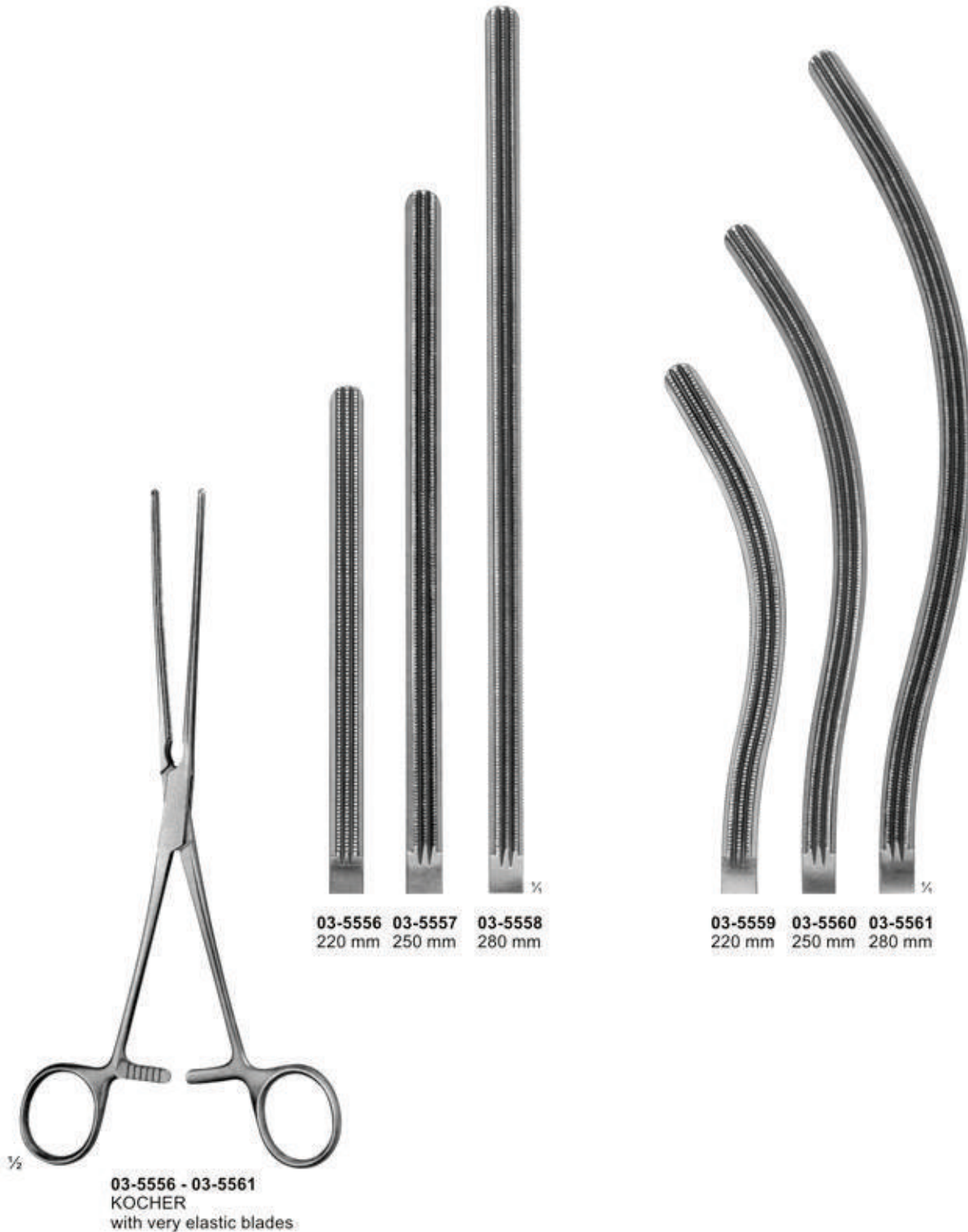



**Intestinal Clamps**



03-5562

03-5563

03-5564

**03-5562 - 03-5563**  
NUSSBAUM  
with elastic blades  
250 mm

**03-5564**  
MOYNIHAN  
280 mm



# Intestinal Clamps

*Splenor Surgicals*

## Atraumata



03-5565

03-5566

1/2

03-5565 - 03-5566  
MAYO-ROBSON  
hard elastic  
250 mm

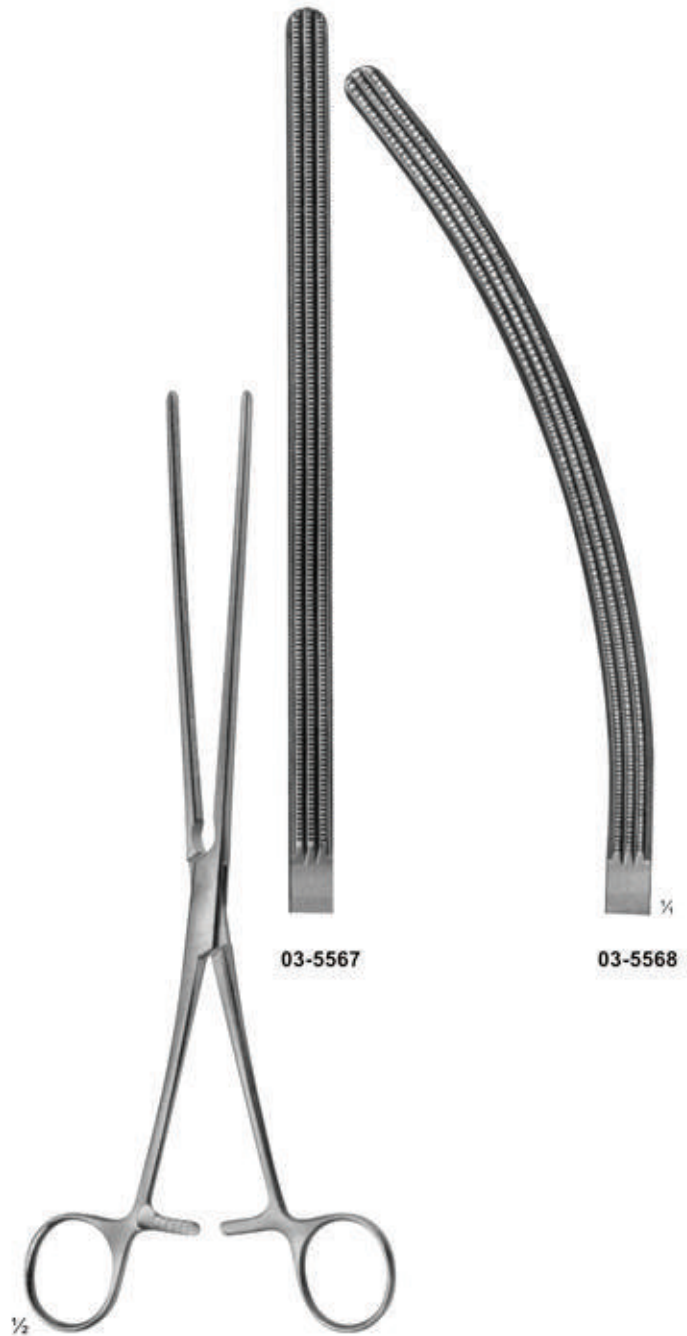

03-5567

03-5568

1/2

03-5567 - 03-5568  
MAYO-ROBSON  
250 mm



Gastro-Intestinal Forceps, twin

*Splenor Surgicals*



03-5569  
LANE  
300 mm

03-5570  
LANE  
300 mm





# Stomach Clamps

*Splenor Surgicals*

Atraumata





# Intestinal and Pylorus Clamps

*Splenor Surgicals*



**03-5574**  
PAYR  
Intestinal clamp  
light pattern,  
for children  
180 mm

**03-5575**  
PAYR  
200 mm

**03-5576**  
PAYR  
275 mm

**03-5577**  
PAYR  
Pylorus clamp  
315 mm



# Anastomosis Forceps

*Splenor Surgicals*

## Atraumata



**03-5578**  
PARKER-KERR  
anastomosis forceps  
for colon resection  
250 mm



**03-5579** 255 mm  
**03-5580** 265 mm  
**03-5581** 275 mm

**03-5579 - 03-5581**  
DICK  
pressure clamps



# Sigmoid Anastomosis Forceps

*Splenor Surgicals*



03-5582  
60mm

03-5583  
80mm

1/2

1/2

1/2

03-5582 - 03-5583  
230 mm

03-5584  
LLOYD-DAVIS  
315 mm



# Atraumata Sigmoid Anastomosis Forceps

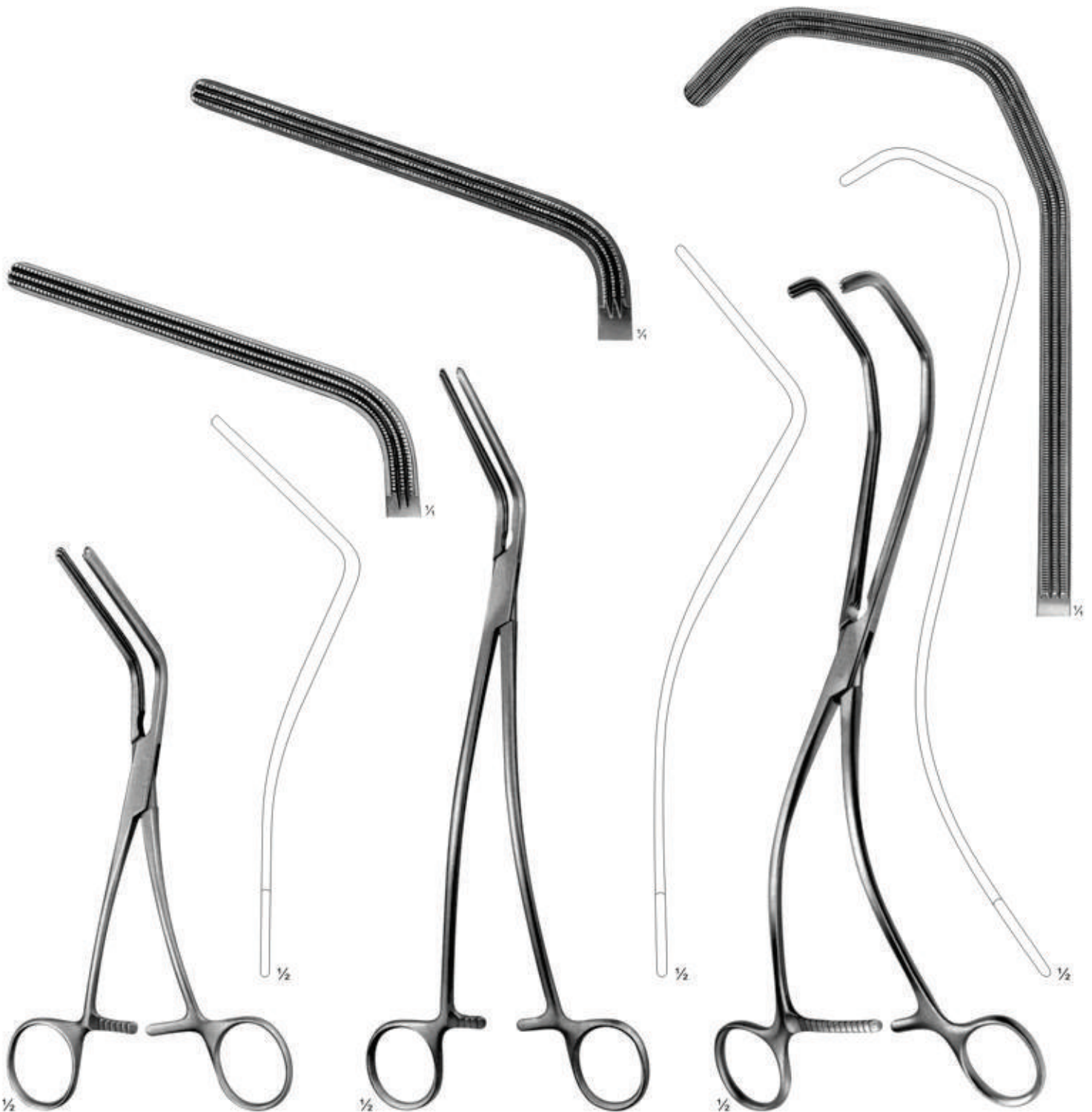

**03-5585**  
MORRIS  
175 mm

**03-5586**  
DE BAKEY  
(MORRIS modif.)  
240 mm

**03-5587**  
KERSTING  
270 mm



03-5588  
KILLIAN  
for children  
145 mm



03-5589  
SIMS  
160 mm



03-5590  
SIMS  
160 mm



Rectal Specula



03-5591 - 03-5594



03-5591  
SIMS  
for children  
190 mm



03-5592  
235 mm



03-5593  
SIMS  
for adults  
235 mm

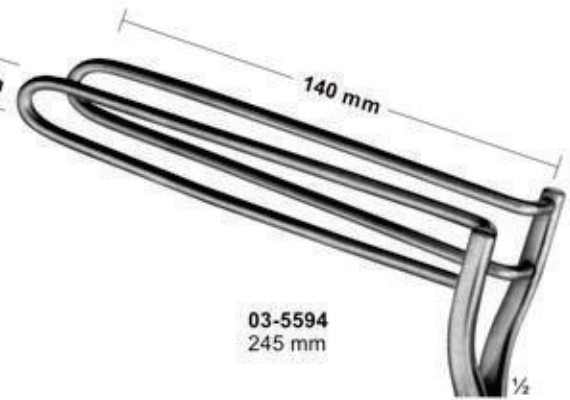

03-5594  
245 mm



03-5595  
PRATT  
205 mm

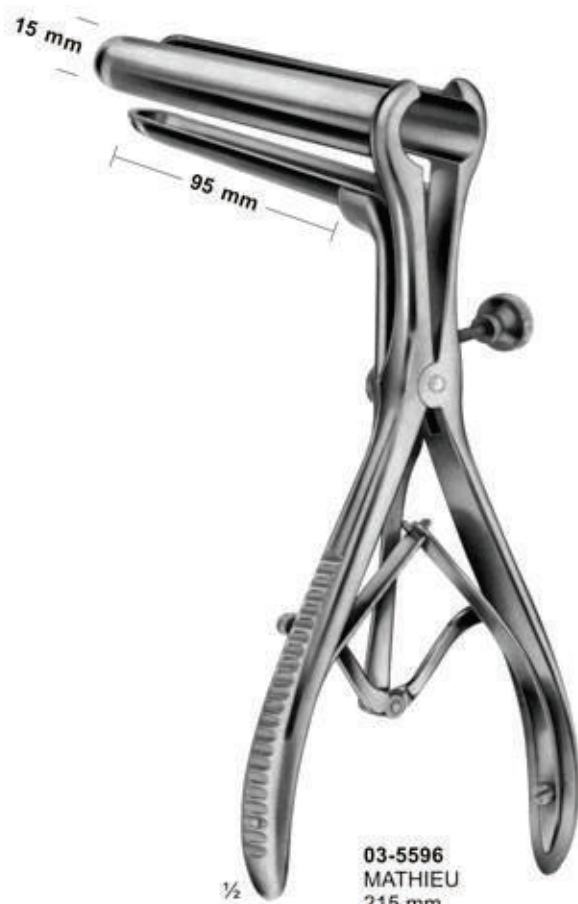

03-5596  
MATHIEU  
215 mm



# Anuscopy-Sphincteroscopes, Proctoscopes



03-5597  
IVES-FANSLER  
Anuscope  
145 mm  
∅ 24mm



03-5598  
KELLY  
Sphincteroscope  
160 mm  
∅ 21mm



03-5599  
KELLY  
Sphincteroscope  
160 mm  
∅ 27mm

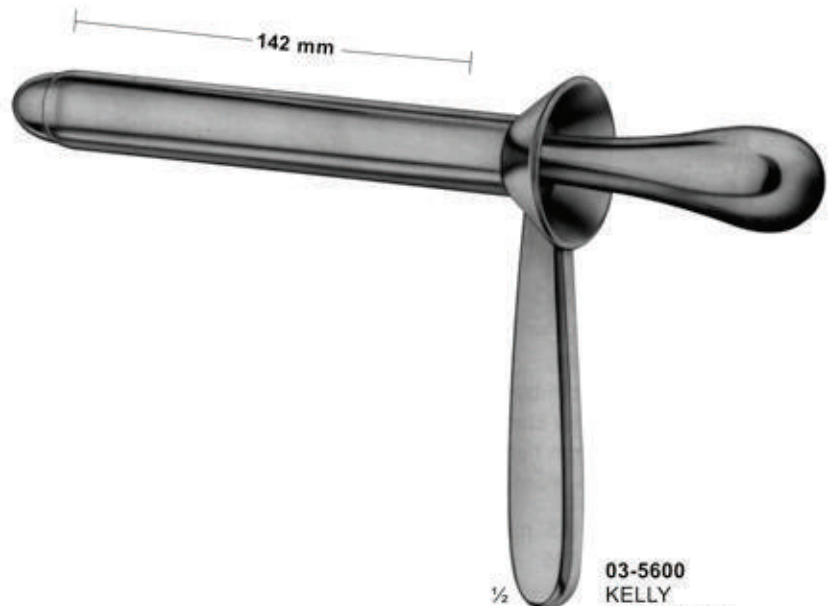

03-5600  
KELLY  
Proctoscope  
140 mm  
∅ 22mm





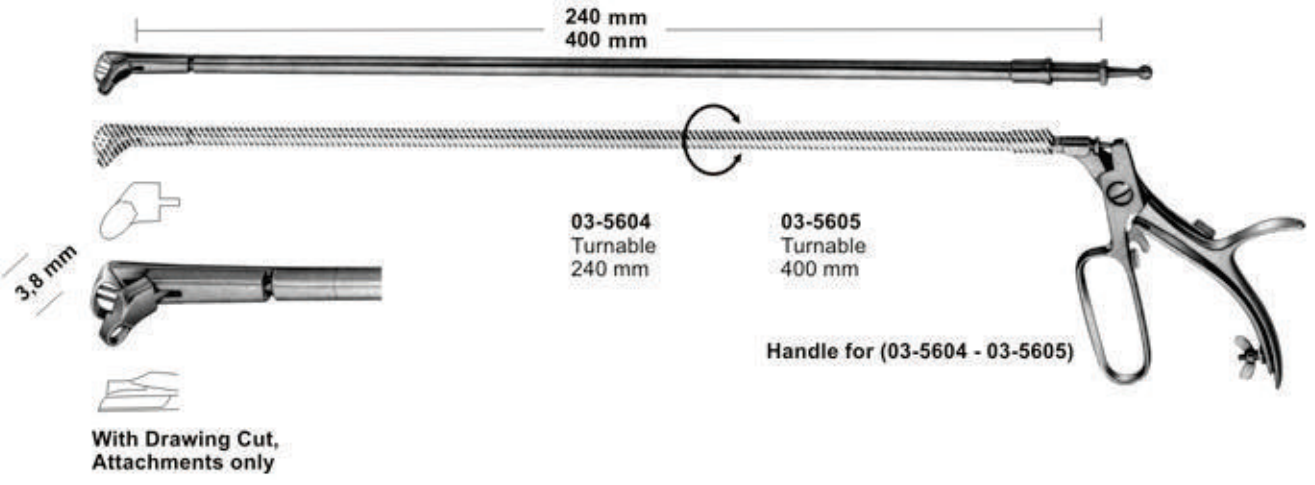
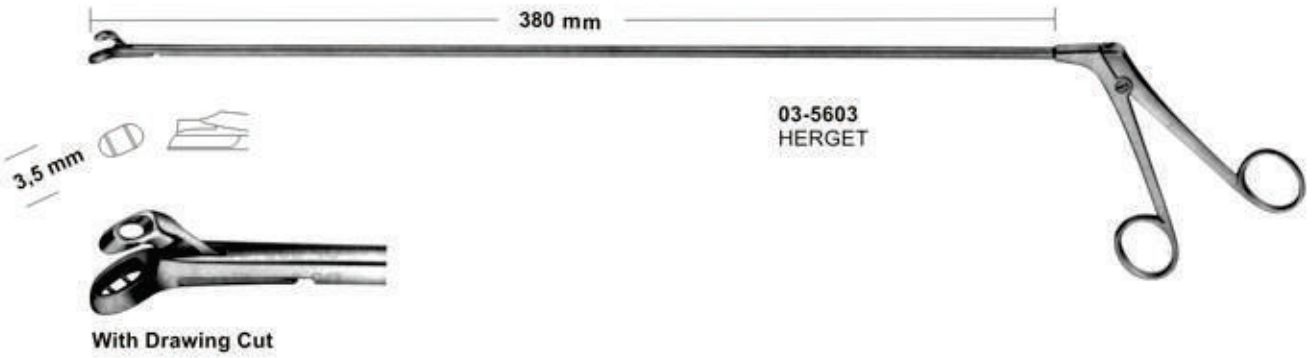
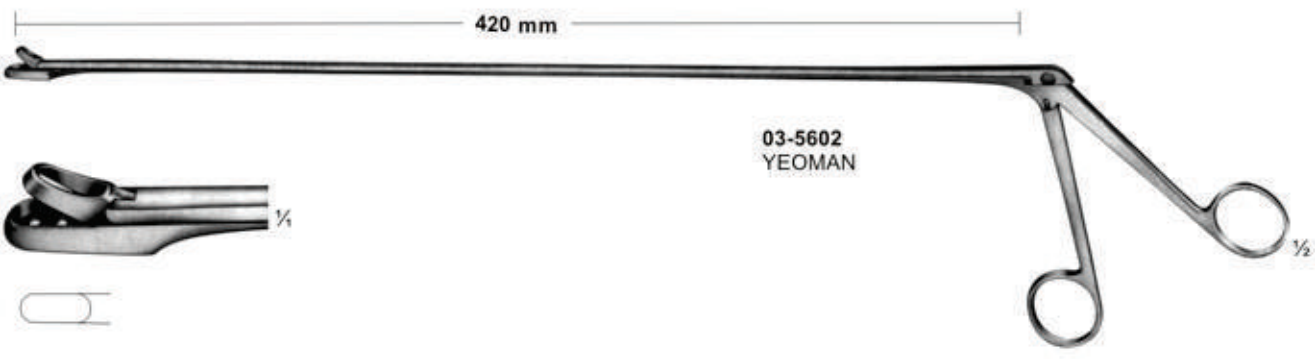
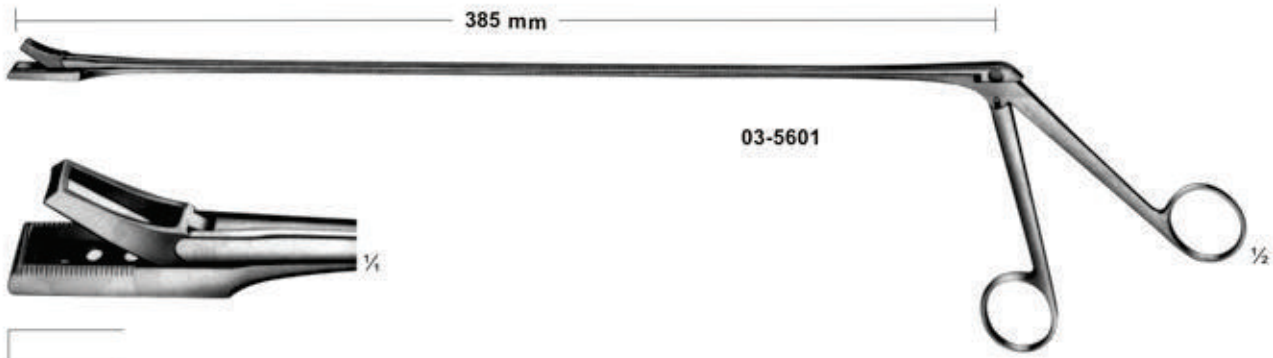

# Biopsy forceps for rectum

Splenor Surgicals

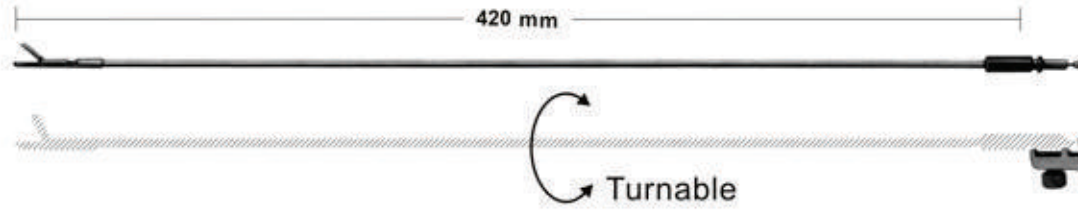

# Biopsy Forceps & Swab Holders



- |        |   |   |   |         |
|--------|---|---|---|---------|
| 3,5 mm |    |    | ¼ | 03-5606 |
| 3,5 mm |    |    | ¼ | 03-5607 |
| 4,0 mm |    |    | ¼ | 03-5608 |
| 4,0 mm |  |  | ¼ | 03-5609 |

Biopsy Forceps

03-5606 - 03-5609  
Handle for

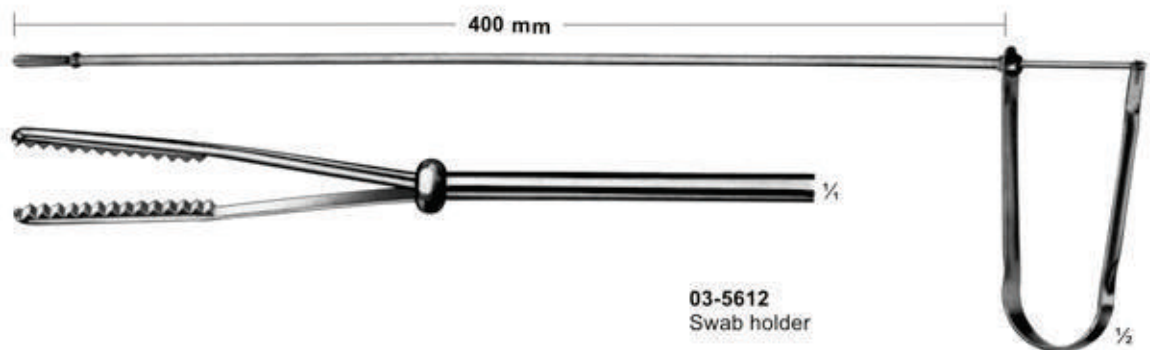
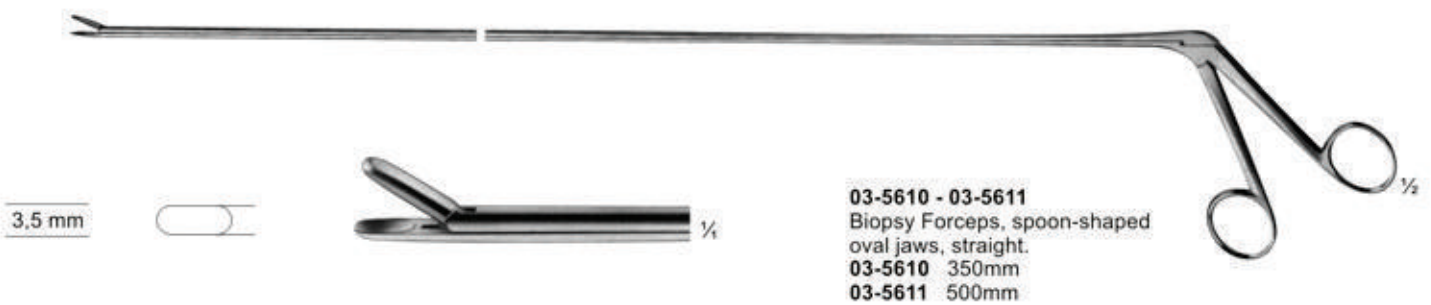



# Haemorrhoidal Forceps

*Splenor Surgicals*



03-5613 - 03-5614  
LUER



03-5615  
HEYWOOD-SMITH  
200 mm



03-5616  
HEYWOOD-SMITH  
modif  
215 mm



# Haemorrhoidal Forceps

Splenor Surgicals

## Atraumata

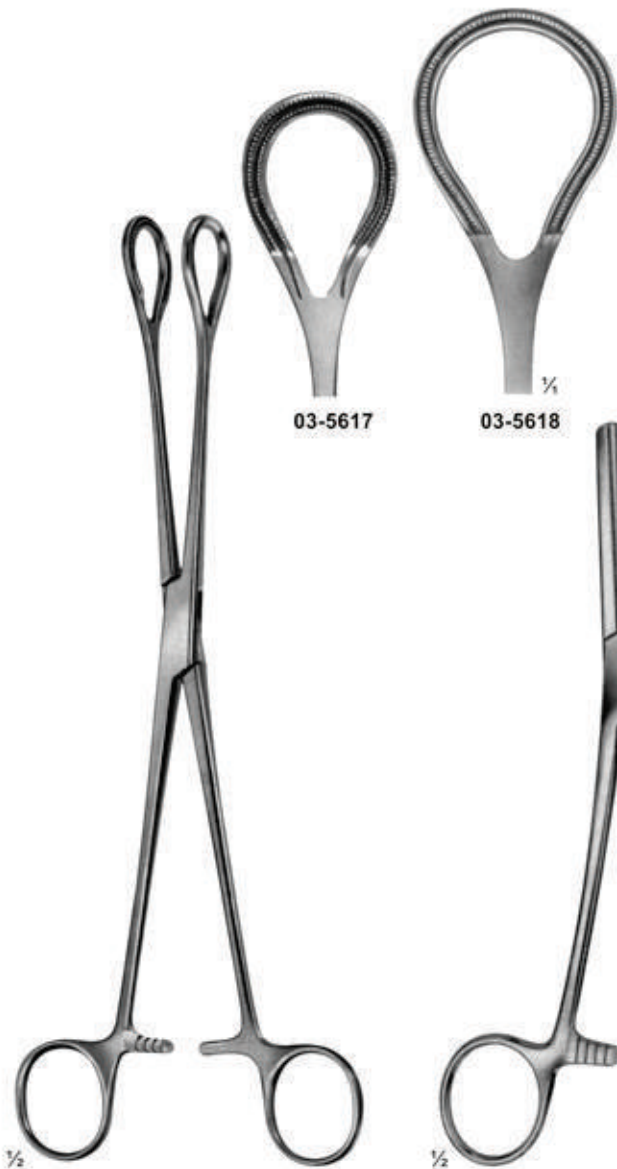

03-5617  
250 mm  
03-5618  
270 mm

## Pressure Clamp

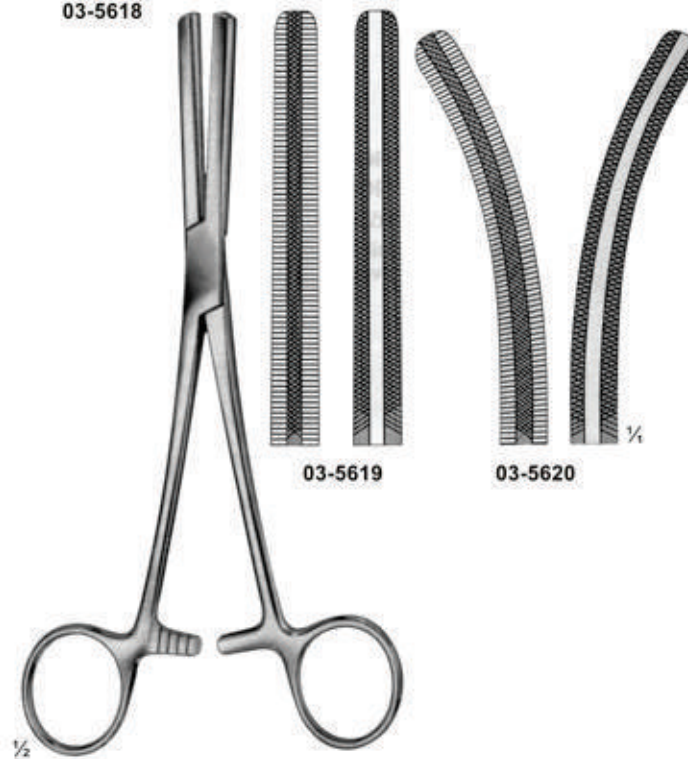

03-5619 - 03-5620  
FERGUSSON  
200 mm



03-5621  
RUDD  
Haemorrhoidal ligator  
with loading  
attachment and 100  
ligature rubber rings  
315 mm



# Gall Duct Forceps

*Splenor Surgicals*



**03-5622**  
LOWER  
180 mm



**03-5623**  
LAHEY ( SWEET )  
190 mm



**03-5624**  
LAHEY  
220 mm



**03-5625**  
DESJARDINS  
Gall duct-and cystic forceps  
210 mm



**03-5626**  
NISSEN  
Gall duct-and cystic forceps  
215 mm



# Gall Duct Forceps and Choledochus Forceps

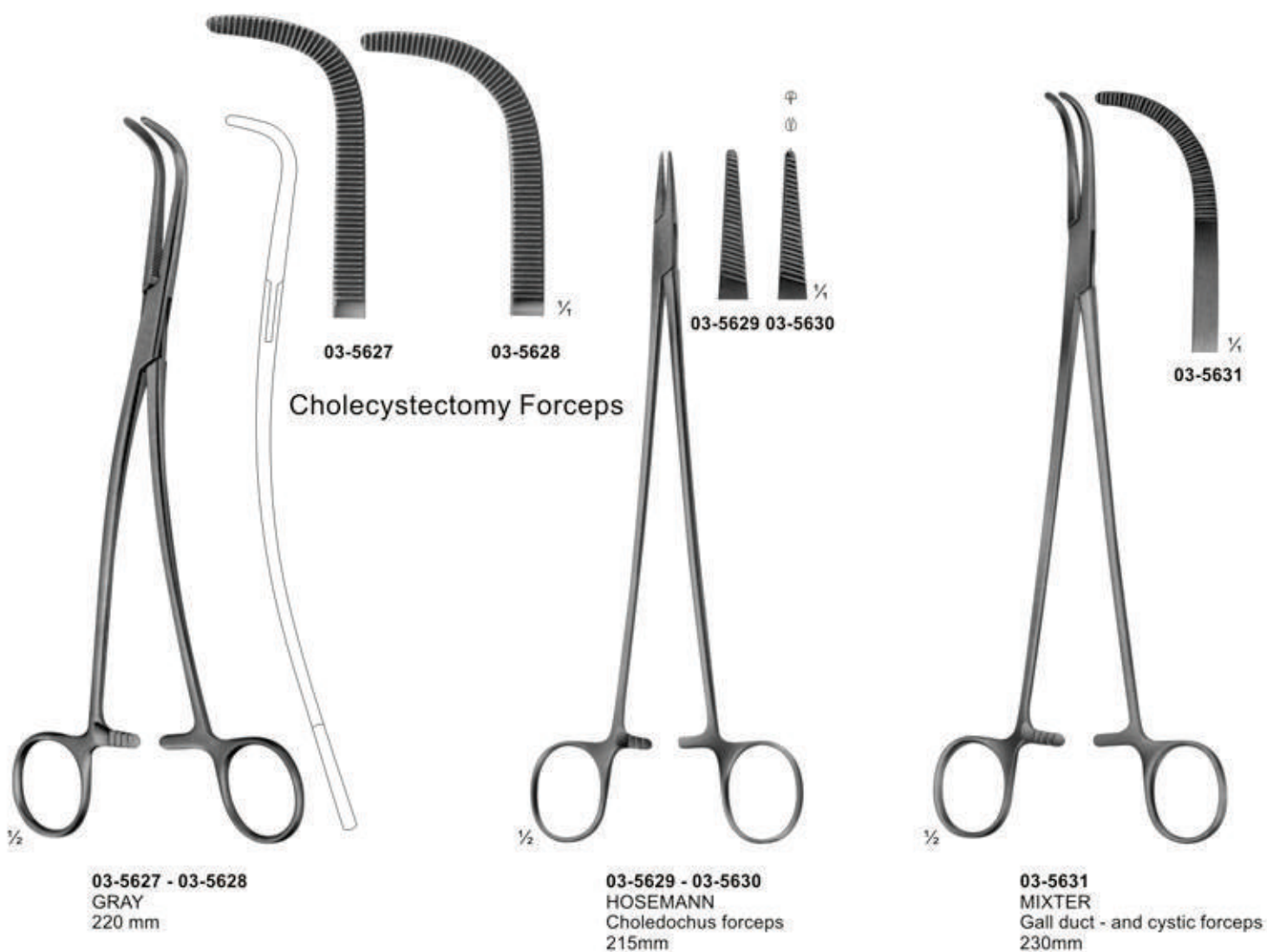



# Gall Bladder Forceps and Gall Duct Scissors

Atraumata

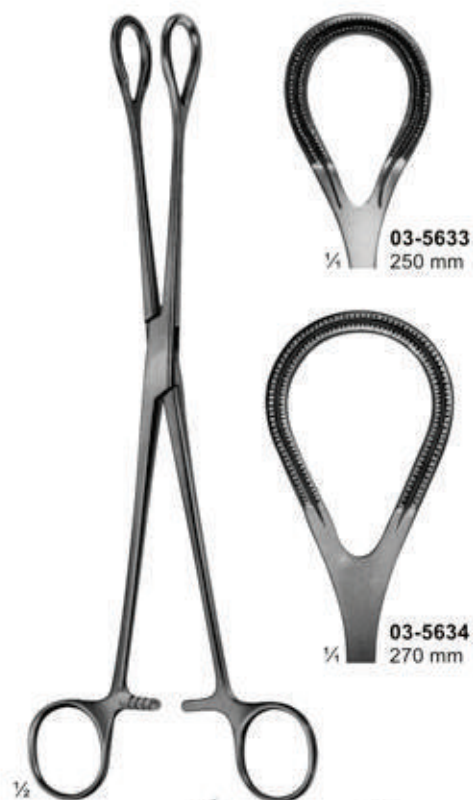



# Gall Duct Probes

Splenor Surgicals

Ø 3.5 mm



1/2  
**03-5639**  
**HAJEK**  
Irrigating cannula,  
silver  
165 mm

Ø 5 mm



1/2  
**03-5640**  
**MOYNIHAN**  
Gall stone probe  
and scoop of tin,  
malleable.  
365 mm

Ø 5 mm



1/2  
**03-5641**  
**MAYO**  
Gall duct probes,  
malleable  
330 mm

Ø 3.5 mm

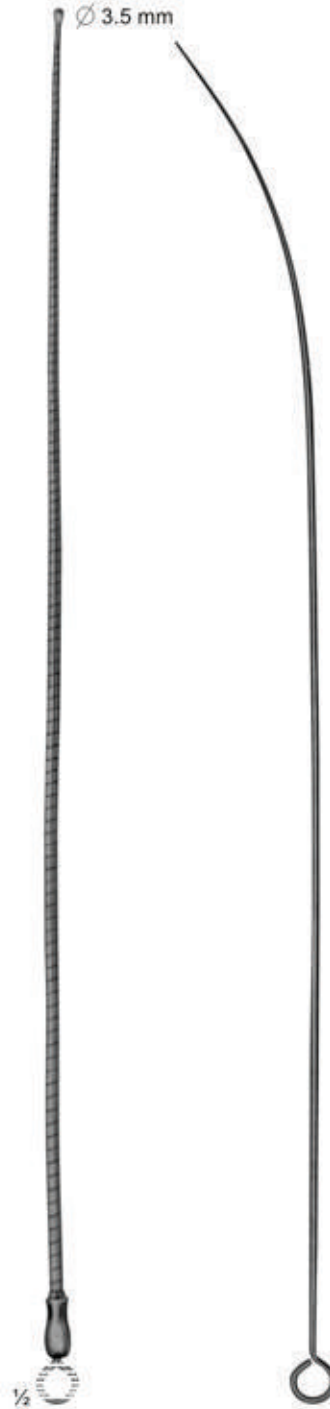

1/2  
**03-5642**  
**OCHSNER**  
Gall duct probes, flexible  
400 mm

Ø 3.8 mm



1/4  
**03-5643**



1/4  
**03-5644**  
Ø 4.3mm



1/4  
**03-5645**  
Ø 6.8mm

1/2  
**03-5643 - 03-5645**  
**DESJARDINS**  
Gall duct probes,  
flexible  
285 mm



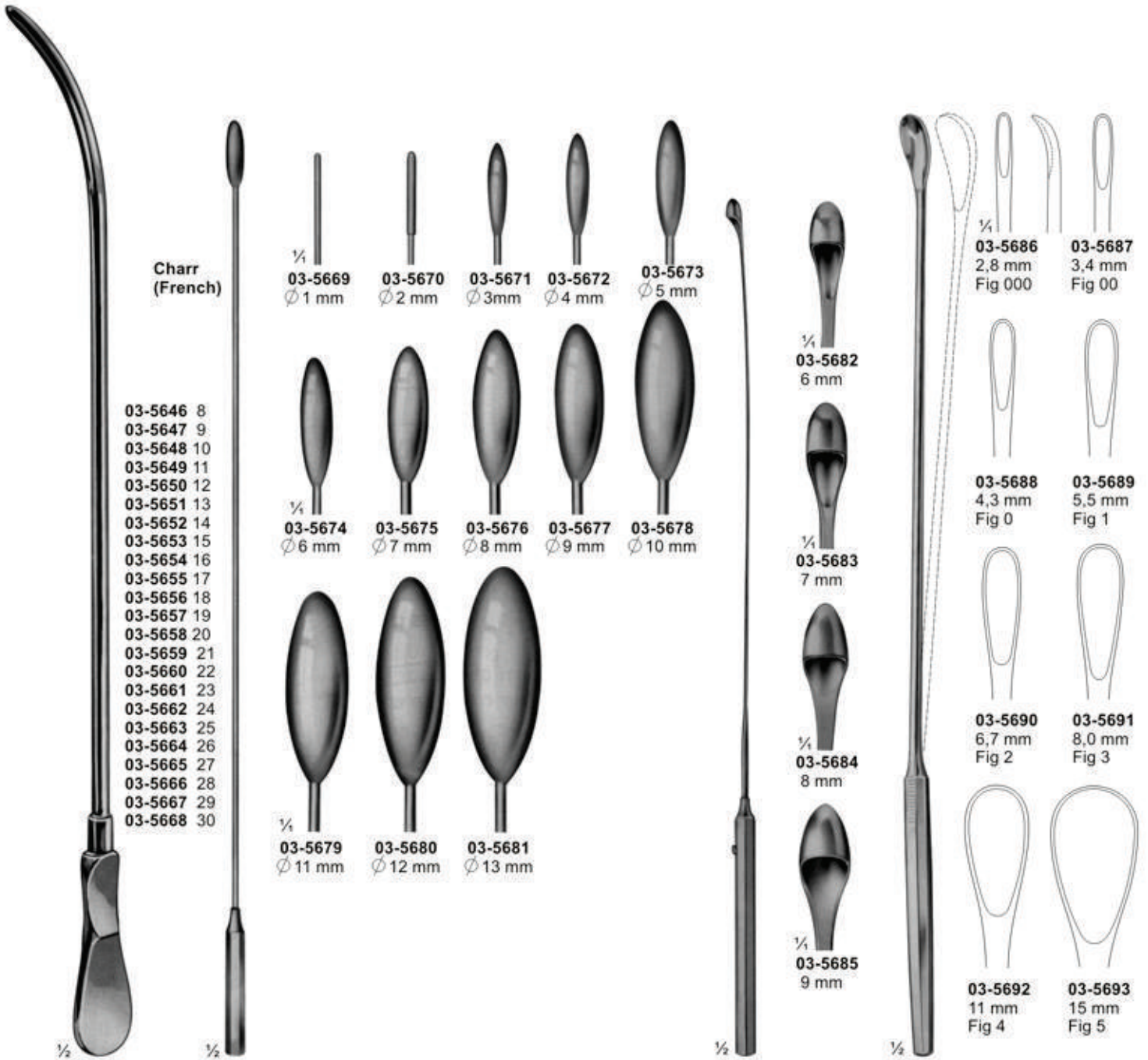

**Charr  
(French)**

- 03-5646 8
- 03-5647 9
- 03-5648 10
- 03-5649 11
- 03-5650 12
- 03-5651 13
- 03-5652 14
- 03-5653 15
- 03-5654 16
- 03-5655 17
- 03-5656 18
- 03-5657 19
- 03-5658 20
- 03-5659 21
- 03-5660 22
- 03-5661 23
- 03-5662 24
- 03-5663 25
- 03-5664 26
- 03-5665 27
- 03-5666 28
- 03-5667 29
- 03-5668 30

- 1/4 03-5669  $\varnothing$  1 mm
- 03-5670  $\varnothing$  2 mm
- 03-5671  $\varnothing$  3mm
- 03-5672  $\varnothing$  4 mm
- 03-5673  $\varnothing$  5 mm
- 1/4 03-5674  $\varnothing$  6 mm
- 03-5675  $\varnothing$  7 mm
- 03-5676  $\varnothing$  8 mm
- 03-5677  $\varnothing$  9 mm
- 03-5678  $\varnothing$  10 mm
- 1/4 03-5679  $\varnothing$  11 mm
- 03-5680  $\varnothing$  12 mm
- 03-5681  $\varnothing$  13 mm

- 1/4 03-5682 6 mm
- 1/4 03-5683 7 mm
- 1/4 03-5684 8 mm
- 1/4 03-5685 9 mm

- 1/4 03-5686 2,8 mm Fig 000
- 03-5687 3,4 mm Fig 00
- 03-5688 4,3 mm Fig 0
- 03-5689 5,5 mm Fig 1
- 03-5690 6,7 mm Fig 2
- 03-5691 8,0 mm Fig 3
- 03-5692 11 mm Fig 4
- 03-5693 15 mm Fig 5

**03-5646 - 03-5668**  
DITTEL  
Metal bougies and dilating sounds, stiff 345 mm

**03-5669 - 03-5681**  
BAKES  
Common bile duct dilators, malleable  
03-5669-03-5673 315mm  
03-5674-03-5681 320mm  
Set of 9 pieces (03-5671-03-5679) in canvas roll

**03-5682 - 03-5685**  
DESJARDINS  
Probes and catch with flexible shaft 300 mm

**03-5686 - 03-5693**  
LUER-KOERTE  
modif with malleable shaft 310 mm



# Gall Stone Forceps

*Splenor Surgicals*



**03-5694  
BLAKE  
205 mm**



**03-5695  
BLAKE  
205 mm**



**03-5696  
CZERNY  
245 mm**



**03-5697 - 03-5700  
DESJARDINS  
225 mm**



**03-5697 03-5698  
03-5699 03-5700**

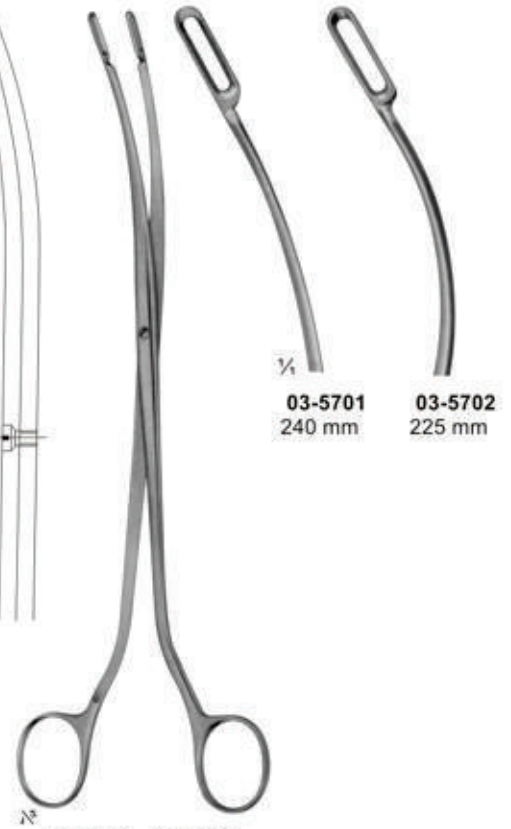

**03-5701 - 03-5702  
DESJARDINS  
Extremely delicate patterns**



# Kidney Clamps

*Splenor Surgicals*

Atraumata

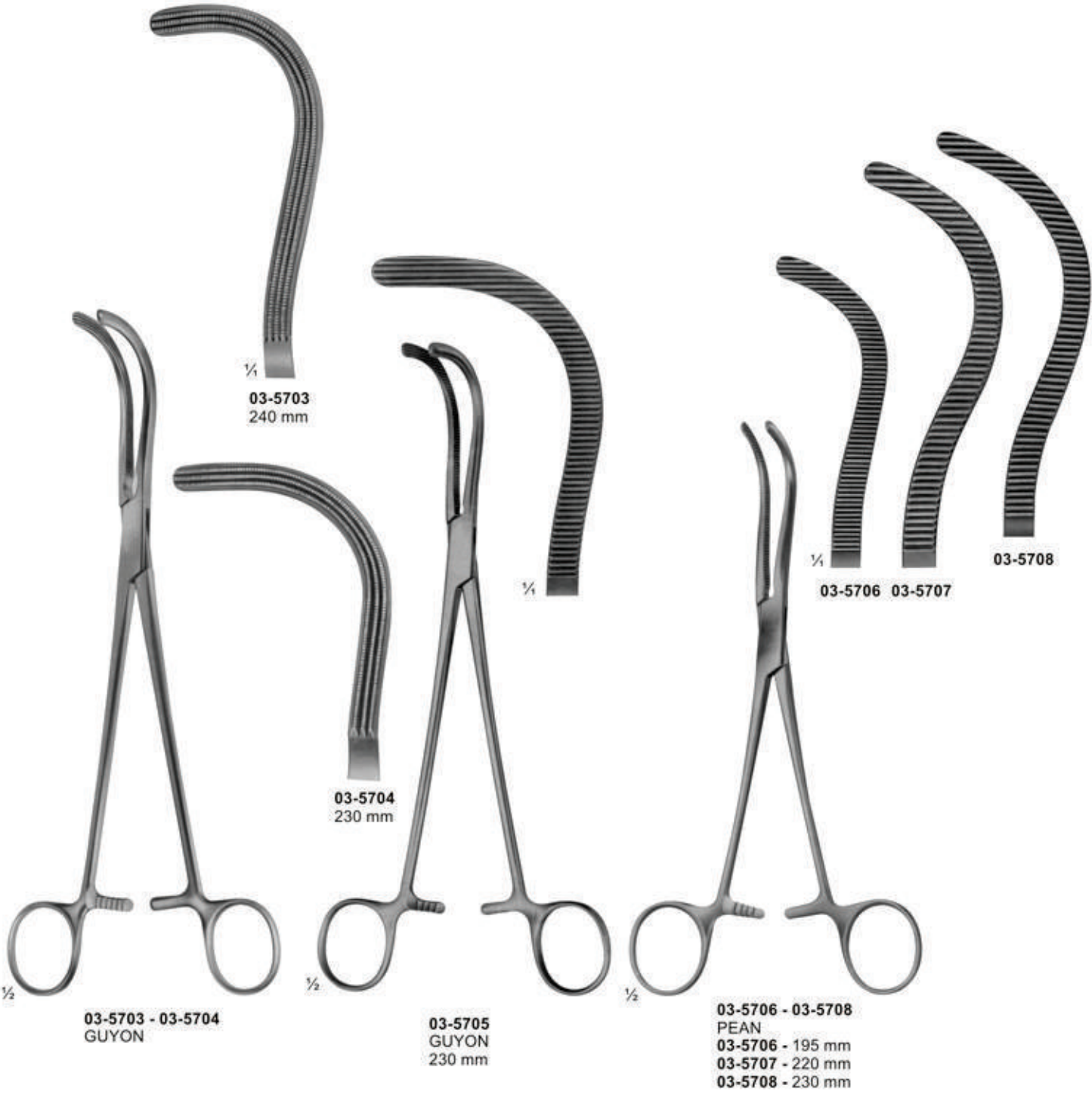



# Kidney and Pedicle Clamps

*Splenor Surgicals*



**03-5709**  
STILLE  
220 mm

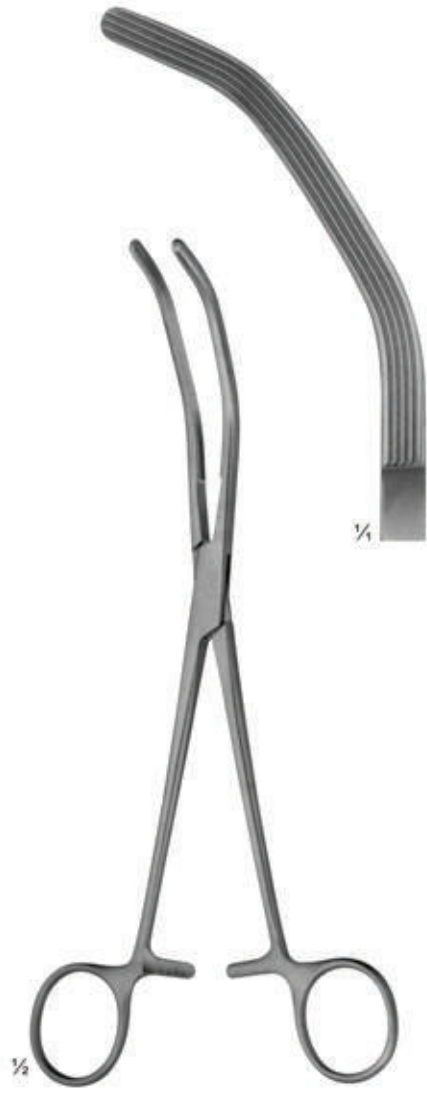

**03-5710**  
HERRICK  
225 mm



**03-5711**  
WERTHEIM  
225 mm



**Kidney Elevating Forceps**



**03-5712**  
COLLIN  
285 mm



**03-5713**  
DARTIGUES  
255 mm

# Kidney Stone Forceps



03-5714 - 03-5717  
RANDALL  
225 mm



03-5718 - 03-5719  
RANDALL  
190 mm



# Bladder Retractors

Splenor Surgicals

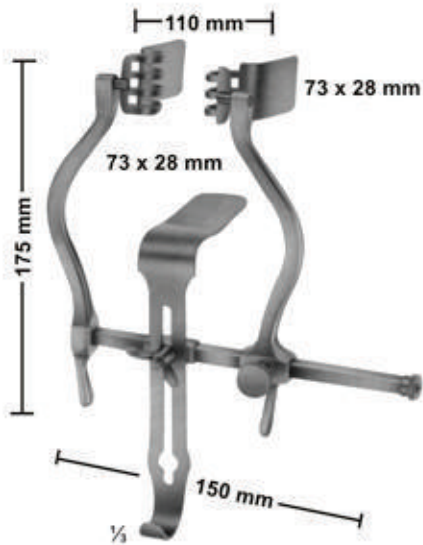

**03-5720**  
JUDD-MASSON  
Bladder and suprapubic retractor

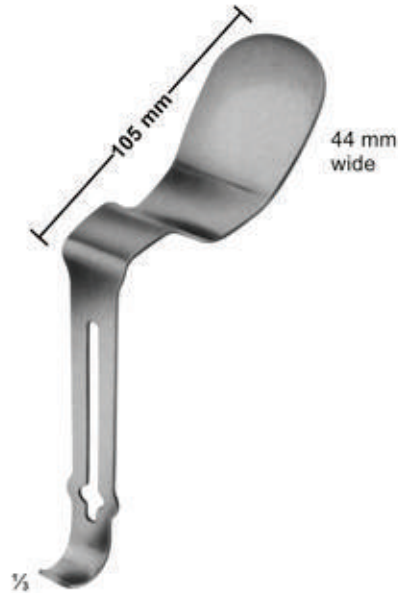

**03-5721**  
MILLIN  
Center blade for ( 05-6993 )  
retro pubic prostatectomy.



**03-5722**  
MILLIN  
Bladder retractor  
**03-5722** Spreader only  
**03-5723** Blades 57x25mm  
**03-5724** Blades 82x25mm  
**03-5725** Center blade 105x45mm



**03-5726**  
LEGUEU  
Bladder retractor  
Center blade  
80 x 31 mm



**03-5727**  
LEGUEU  
Bladder spatula  
260 mm



**03-5728**  
KOCHER  
Bladder spatula  
235 mm



**03-5729**  
**MATHIEU**  
 Foreign body forceps  
 Length of shaft  
 190 mm



**03-5730**  
**MILLIN**  
 Lobe grasping  
 forceps  
 235 mm



Atraumata

**03-5731**  
 Ureter forceps  
 240 mm

Atraumata



**03-5732**  
**MILLIN**  
 Lobe grasping  
 forceps  
 245 mm



**03-5733**  
**MILLIN**  
 Bladder neck spreader  
 285 mm





**03-5734**  
GUYON  
Catheter guide  
(introducer)  
365 mm

Charr.  
(French)

- 03-5735 6
- 03-5736 7
- 03-5737 8
- 03-5738 9
- 03-5739 10
- 03-5740 11
- 03-5741 12
- 03-5742 13
- 03-5743 14
- 03-5744 15
- 03-5745 16
- 03-5746 18
- 03-5747 20

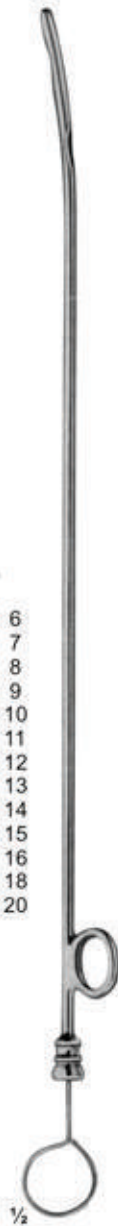

**03-5735 - 03-5747**  
Female catheters,  
metal  
160 mm

Charr.  
(French)

- 03-5748 8
- 03-5749 9
- 03-5750 10
- 03-5751 11
- 03-5752 12
- 03-5753 13
- 03-5754 14
- 03-5755 15
- 03-5756 16
- 03-5757 17
- 03-5758 18
- 03-5759 19
- 03-5760 20
- 03-5761 21
- 03-5762 22
- 03-5763 23
- 03-5764 24
- 03-5765 25
- 03-5766 26
- 03-5767 27
- 03-5768 28
- 03-5769 29
- 03-5770 30

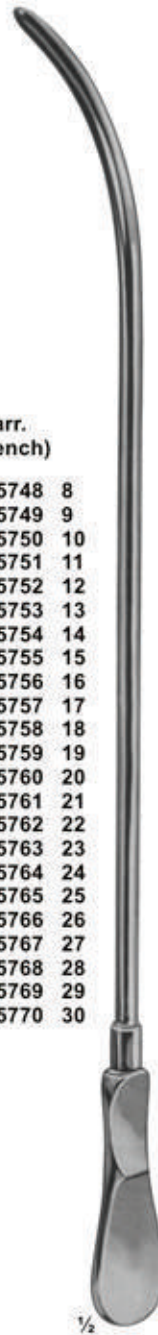

**03-5748 - 03-5770**  
DITTEL  
Urethral bougies  
and dilating sounds  
345 mm

- 03-5771 Ben. 24/Charr. 12
- 03-5772 Ben. 25
- 03-5773 Ben. 26/Charr. 13
- 03-5774 Ben. 27
- 03-5775 Ben. 28/Charr. 14
- 03-5776 Ben. 29
- 03-5777 Ben. 30/Charr. 15
- 03-5778 Ben. 31
- 03-5779 Ben. 32/Charr. 16
- 03-5780 Ben. 33
- 03-5781 Ben. 34/Charr. 17
- 03-5782 Ben. 35
- 03-5783 Ben. 36/Charr. 18
- 03-5784 Ben. 37
- 03-5785 Ben. 38/Charr. 19
- 03-5786 Ben. 39
- 03-5787 Ben. 40/Charr. 20
- 03-5788 Ben. 41
- 03-5789 Ben. 42/Charr. 21
- 03-5790 Ben. 43
- 03-5791 Ben. 44/Charr. 22
- 03-5792 Ben. 45
- 03-5793 Ben. 46/Charr. 23
- 03-5794 Ben. 47
- 03-5795 Ben. 48/Charr. 24
- 03-5796 Ben. 49
- 03-5797 Ben. 50/Charr. 25
- 03-5798 Ben. 51
- 03-5799 Ben. 52/Charr. 26
- 03-5800 Ben. 53
- 03-5801 Ben. 54/Charr. 27
- 03-5802 Ben. 55
- 03-5803 Ben. 56/Charr. 28
- 03-5804 Ben. 57
- 03-5805 Ben. 58/Charr. 29
- 03-5806 Ben. 59
- 03-5807 Ben. 60/Charr. 30

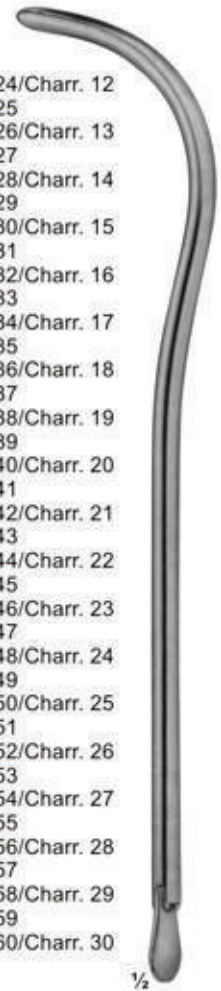

**03-5771 - 03-5807**  
GUYON  
Urethral bougies  
and dilating sounds,  
without filiform guides,  
with thread in tip  
255 mm



**03-5808**  
GUYON  
Set of urethral bougies and dilating sounds,  
in metal case, with lift out rack and bottom  
rack, containing 21 urethral and dilating sounds, metal.



**03-5809 - 03-5811**  
WINKELMANN  
**03-5809** ∅ 12mm  
**03-5810** ∅ 16mm  
**03-5811** ∅ 20mm

Circumcision Clamps

Assisted by two haemostats or ligatures the foreskin is pushed over the bellshaped protection - rod and the glans is placed into it.  
By now, the wing - nut is tightened as close as possible, so the foreskin in annular compressed. The foreskin is cut of with a scalpel, right next to the compression ring. The circumcision clamp remains a few minutes to avoid bleeding. In case that any large vein, specially the frenular artery, is cut through, a ligature must be set.  
The advantage of the method described is the cosmeticly favourable scar which is left after rejection of the small necrotized portion.



# Trocars

Splenor Surgicals

Luer Lock



**03-5812**  
KLIMA ROSEGGER  
35 X 1,8 mm  
Sternal puncture needle

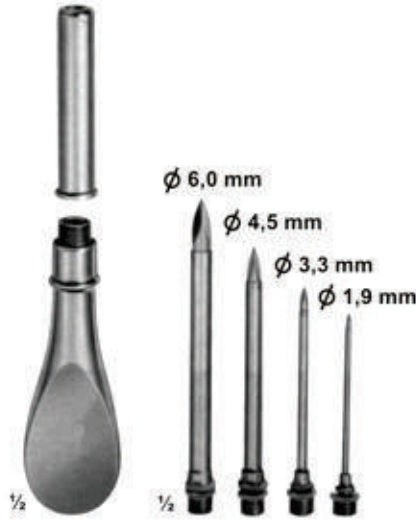

**03-5813**  
Universal trocar  
with 4 tips

∅ 6,0 mm  
∅ 4,5 mm  
∅ 3,3 mm  
∅ 1,9 mm



**03-5814 - 03-5818**  
NELSON

	Inside diam	Outside diam
<b>03-5814</b>	2,2 mm	3,0 mm
<b>03-5815</b>	3,0 mm	4,0 mm
<b>03-5816</b>	4,0 mm	5,0 mm
<b>03-5817</b>	5,0 mm	6,0 mm
<b>03-5818</b>	5,5 mm	6,5 mm

for hydrocele and abdominal puncture



**03-5819 - 03-5822**

	Inside diam	Outside diam
<b>03-5819</b>	2,2 mm	3,0 mm
<b>03-5820</b>	3,0 mm	4,0 mm
<b>03-5821</b>	4,0 mm	5,0 mm
<b>03-5822</b>	5,0 mm	6,0 mm

for abdominal puncture, with stop-cock and lateral drain



**03-5823** 100 mm  
**03-5824** 110 mm

**03-5823 - 03-5824**  
BUELAU

	Inside diam	Outside diam
<b>03-5823</b>	6,5 mm	8,0 mm
<b>03-5824</b>	9,0 mm	10,0 mm

Empyema trocar



**03-5825 - 03-5828**  
OCHSNER

	Inside diam	Outside diam
<b>03-5825</b>	3,0 mm	4,0 mm
<b>03-5826</b>	3,6 mm	4,6 mm
<b>03-5827</b>	4,3 mm	5,3 mm
<b>03-5828</b>	5,0 mm	6,0 mm

Gall bladder trocars



Record Cone 1

**03-5829**  
PIERCE  
Antrum trocar  
∅ 4,0 mm



Luer Lock Cone

**03-5830**  
COAKLEY  
Antrum trocar  
∅ 3,0 mm



*Splenor Surgicals*

## Section - 04



**Pages 209-254**

- ★ Vaginal Specula & Retractors
- ★ Utrine Dilators, Probes,  
Forceps, Myoma Instruments
- ★ Biopsy Instruments,  
Utrine Curettes / Scoops
- ★ Obstetrics Instruments



# Vaginal specula

# Splenor Surgicals

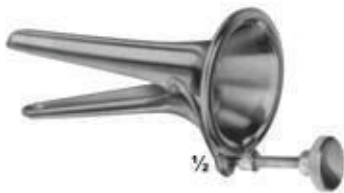

**04-6001**  
COLLIN  
for children  
53 x 10 mm

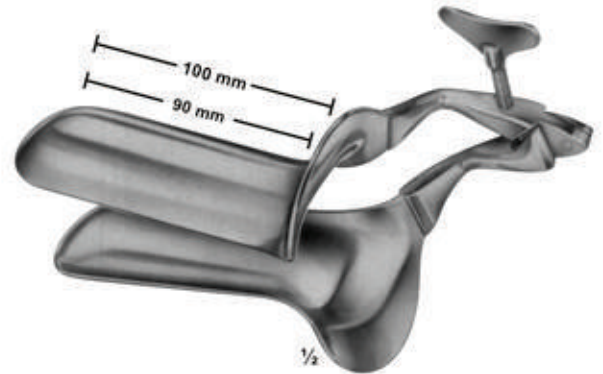

<b>04-6002 - 04-6005</b>			
COLLIN			
<b>04-6002</b>	100/90mm	28 mm	
<b>04-6003</b>	100/90mm	32 mm	
<b>04-6004</b>	105/95mm	35 mm	
<b>04-6005</b>	115/105mm	40 mm	
	Total length/working length		width



**04-6006**  
COLLIN  
for virgins  
95/85 x 18 mm



**04-6007**  
CUSCO  
for virgins  
75 x 17 mm



**04-6008**  
CUSCO  
for virgins  
75 x 17 mm



**04-6009 - 04-6011**  
CUSCO  
Swiss patterns features:  
long and narrow

<b>04-6009</b>	92X23-25 mm
<b>04-6010</b>	100x25-27 mm
<b>04-6011</b>	110x27-30 mm



# Vaginal Specula

# Splenor Surgicals



**04-6012 - 04-6015**  
 CUSCO  
 STANDARD  
**04-6012** 80X24 mm  
**04-6013** 80X32 mm  
**04-6014** 90X36 mm  
**04-6015** 110X37 mm



**04-6016 - 04-6019**  
 CUSCO  
**04-6016** 80X24 mm  
**04-6017** 80X32 mm  
**04-6018** 90X36 mm  
**04-6019** 110X37 mm



Flat (duck beak)

**04-6020 - 04-6022**  
 CUSCO  
**04-6020** 80X32 mm  
**04-6021** 90X37 mm  
**04-6022** 115X37 mm



**04-6023 - 04-6024**  
 SEYFFERT  
**04-6023** 100X17 mm  
**04-6024** 110X33 mm  
 230 mm



With double ratchet, closing and opening of ratchet by pressure of thumb

**04-6025**  
 SEMM  
 for children  
 and virgins  
 180 mm  
 90X14-18mm



# Vaginal Specula, Sets, Upper & Lower Blades



**04-6026 - 04-6028**  
GRAVE  
04-6026 75X20 mm  
04-6027 95X30 mm  
04-6028 105X33 mm



**04-6029 - 04-6030**  
PEDERSON  
04-6029 100X22 mm  
04-6030 120X25 mm



**04-6031 - 04-6032**  
BRIESKY  
04-6031 72X25 mm / 77X30 mm 140mm  
04-6032 75X30 mm / 92X38 mm 170mm



**04-6033 - 04-6035**  
SIMS  
04-6033 70X26 mm / 75 X30 mm  
125 mm  
04-6034 75X30 mm / 80X35 mm  
150 mm  
04-6035 80X36 mm / 90X40mm  
175mm



**04-6036 - 04-6038**  
SEIDL  
04-6036 80X8 mm  
04-6037 80X10 mm  
04-6038 90X14 mm  
For children and infants  
170 mm



**04-6039**  
KRISTELLER  
70X15 mm, ( 170 mm )  
For children



**04-6040 - 04-6042**  
KRISTELLER  
04-6040 70X27 mm  
04-6041 75X30 mm  
04-6042 90X36 mm  
175 mm



Vaginal Specula-Sets, upper and lower blades







### Vaginal Specula-upper and lower blades

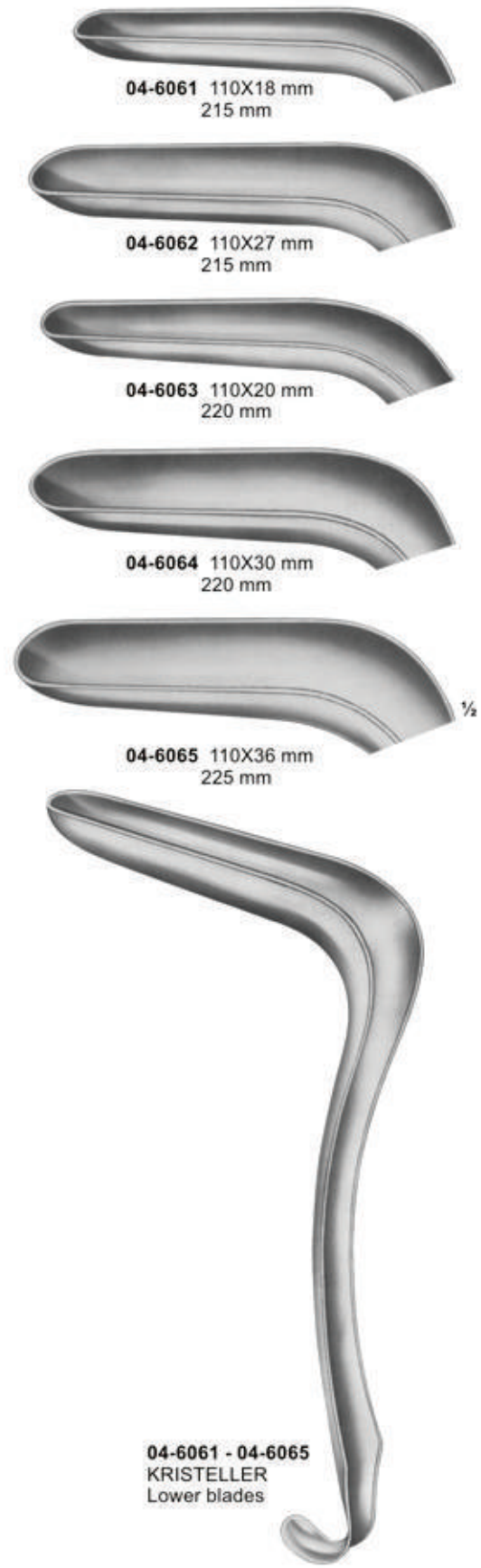
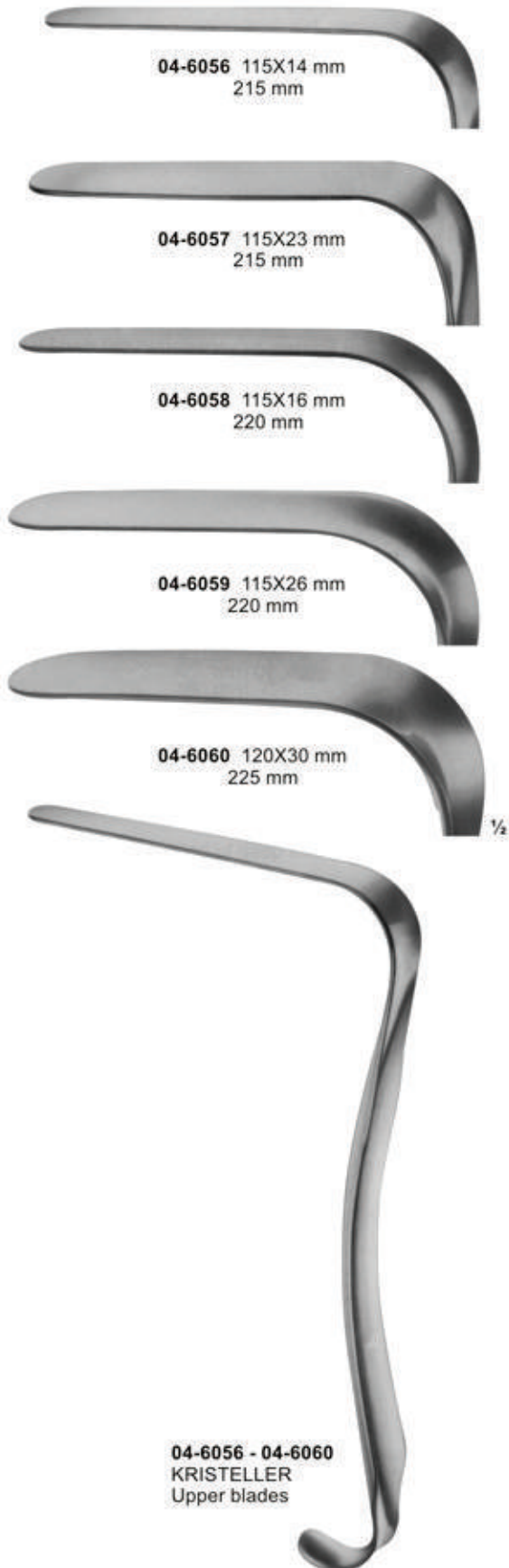



# Vaginal Specula

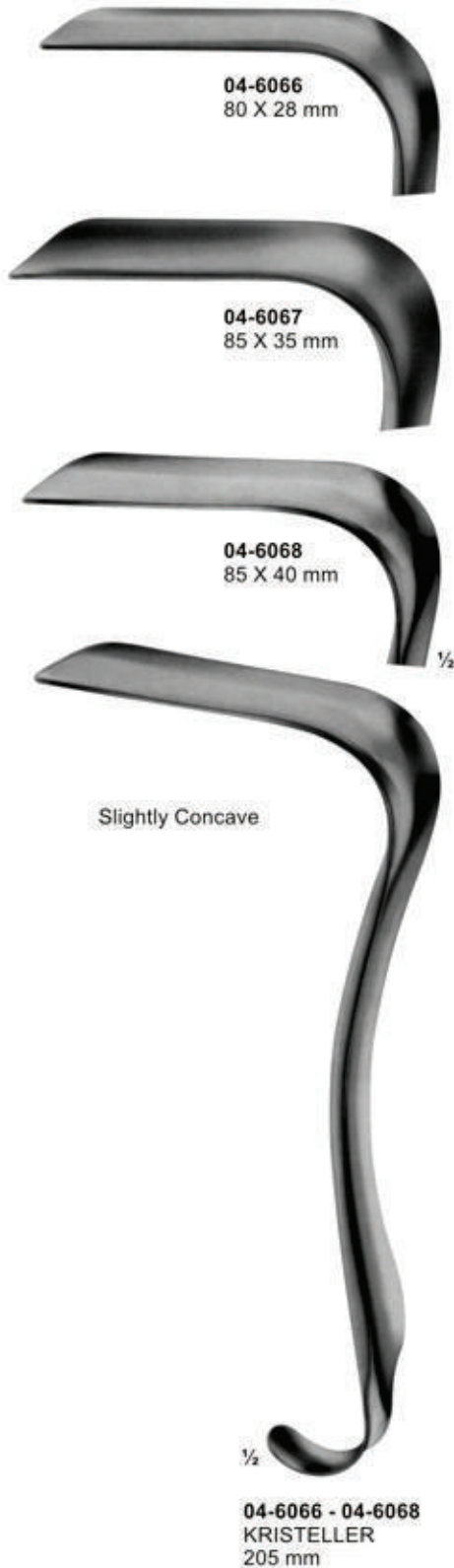



# Vaginal Specula-for children & virgins Vario Retractor

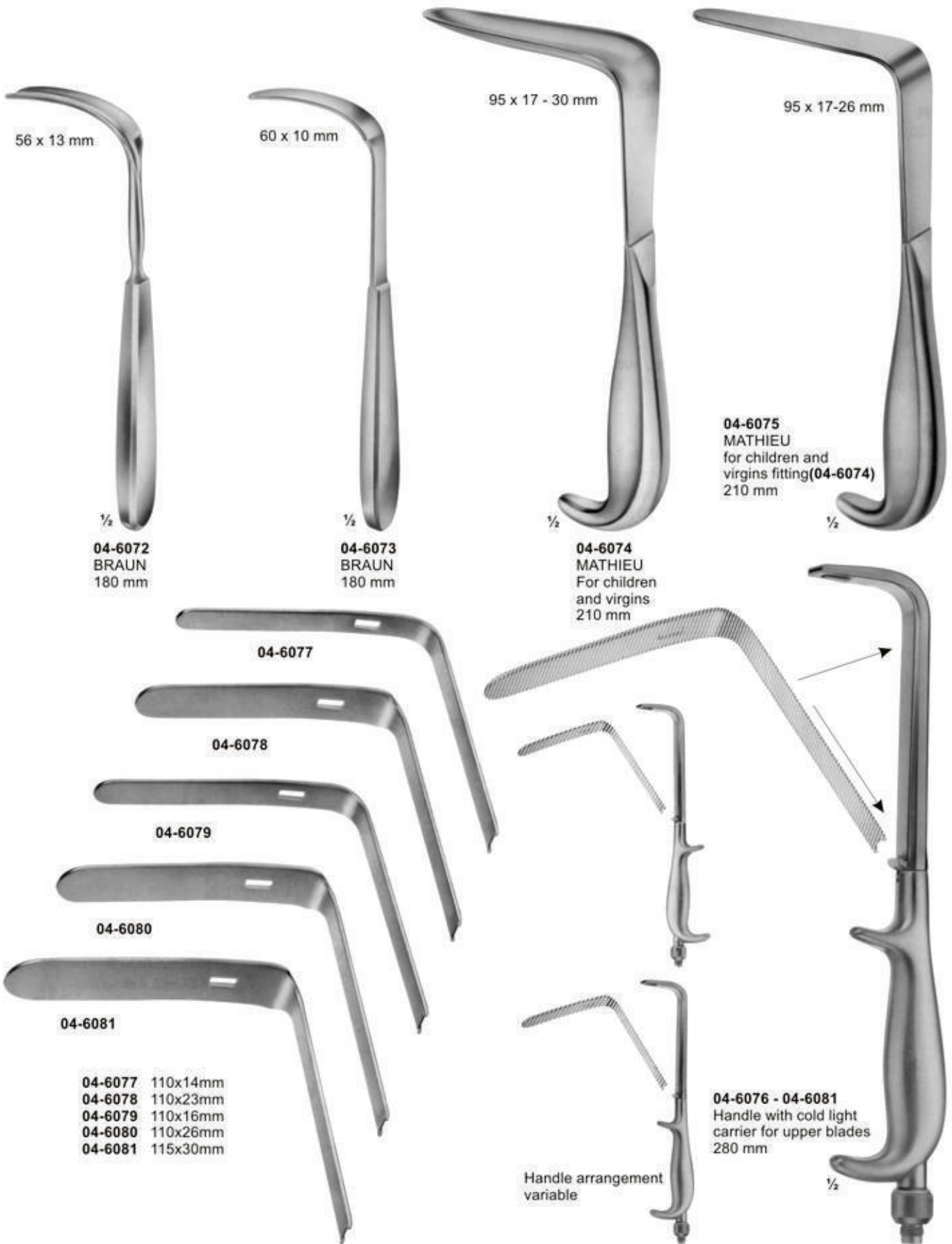

56 x 13 mm

60 x 10 mm

95 x 17 - 30 mm

95 x 17-26 mm

1/2  
**04-6072**  
BRAUN  
180 mm

1/2  
**04-6073**  
BRAUN  
180 mm

1/2  
**04-6074**  
MATHIEU  
For children  
and virgins  
210 mm

**04-6075**  
MATHIEU  
for children and  
virgins fitting(04-6074)  
210 mm

**04-6077**

**04-6078**

**04-6079**

**04-6080**

**04-6081**

**04-6077** 110x14mm  
**04-6078** 110x23mm  
**04-6079** 110x16mm  
**04-6080** 110x26mm  
**04-6081** 115x30mm

**04-6076 - 04-6081**  
Handle with cold light  
carrier for upper blades  
280 mm

Handle arrangement  
variable



# Vaginal Specula-for children and virgins

*Splenor Surgicals*



04-6082 - 04-6084  
DOYEN  
235 mm

Length of blades	Width of blades			DOYEN 240mm
	35 mm	45 mm	60 mm	
60 mm	04-6085	04-6088	04-6091	04-6085 - 04-6094
90 mm	04-6086	04-6089	04-6092	
120 mm	04-6087	04-6090	04-6093	
160 mm		04-6090A	04-6094	



# Vaginal Specula / Retractors

*Splenor Surgicals*



04-6095 - 04-6099  
BREISKY  
WIENER MODELL/  
VIENNA PATTERN  
04-6095 100 X 20 mm  
04-6096 100 X 25 mm  
04-6097 100 X 30 mm  
04-6098 100 X 35 mm  
04-6099 100 X 40 mm  
300 mm

04-6100 - 04-6104  
BREISKY  
WIENER MODELL/  
VIENNA PATTERN  
04-6100 130 X 20 mm  
04-6101 130 X 25 mm  
04-6102 130 X 30 mm  
04-6103 130 X 35 mm  
04-6104 130 X 40 mm  
320 mm

04-6107  
removable strainer only

04-6105 - 04-6106  
WEISSBARTH  
04-6105 80 X 28 mm  
04-6106 85 X 42 mm  
210 mm

04-6108  
DOYEN  
lateral speculum  
80 x 30 mm  
250 mm



# Vaginal & Wound Retractor / Vaginal Specula



**04-6110**  
115 X 26 mm  
275 mm

**04-6109 - 04-6110**  
SIMON  
115 X 22 mm  
275 mm

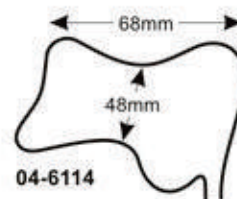

**04-6114**



**04-6115**

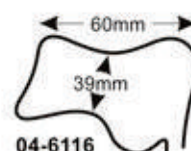

**04-6116**

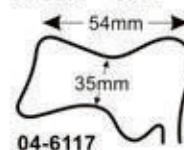

**04-6117**



**04-6111**  
AUVARD  
65 X 38 mm - 28 mm  
1,530 kg = 3 lbs  
with fixed weight  
230 mm

**04-6112 - 04-6113**  
AUVARD  
**04-6112** 75 X 42-40 mm  
**04-6113** 105 X 43-40 mm  
1,470 kg = 3 lbs  
with detachable weight  
230 mm



**04-6114 - 04-6117**  
MARTIN  
with hook shaped  
handle for hanging  
in weights  
270 mm





# Vaginal Speculas



**04-6118**  
80 X 30

**04-6119**  
85 X 35

**04-6120**  
85 X 40



**04-6121**  
55 X 40 - 60 mm



**04-6122**  
70 X 45 - 70 mm



**04-6123**

**04-6124**

The mentioned blades (**04-6118 - 04-6122** and **04-6125 - 04-6132**) can be exchanged. They fit handle (**04-6123**), as well as handles (**04-6133** and **04-6134**).

**04-6118 - 04-6124**  
SCHERBACK  
Set consisting of:  
handle **04-6123**  
weight **04-6124**  
4 blades **04-6118 - 04-6121**



**04-6125**  
80 X 30 mm

**04-6129**  
65 X 30 mm

**04-6126**  
85 X 33 mm

**04-6130**  
75 X 35 mm

**04-6127**  
100 X 38 mm

**04-6131**  
85 X 35 mm

**04-6128**  
110 X 42 mm

**04-6132**  
95 X 35 mm

**04-6133**  
BOZEMANN  
Set consisting of:  
2 handle (**04-6133 - 04-6134**)  
8 blades (**04-6125 - 04-6132**)

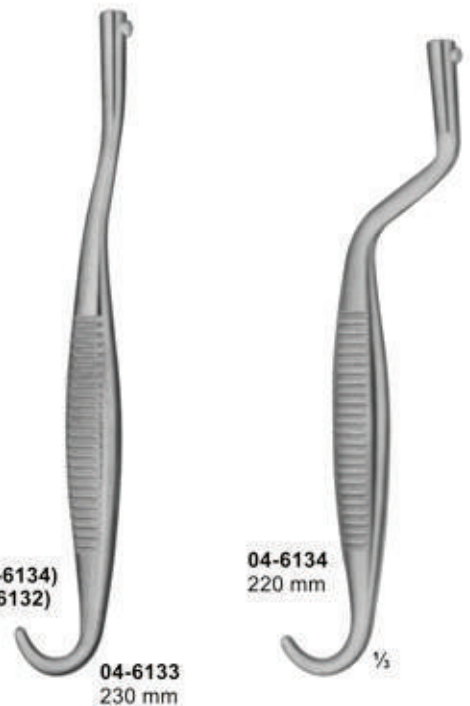

**04-6133**  
230 mm

**04-6134**  
220 mm



# Vaginal Retractors

*Splenor Surgicals*



1/2  
**04-6135**  
JOLL (FRIEDMAN)  
155 mm



1/2  
**04-6136**  
RICHTER  
170 mm



1/2  
**04-6137**  
GELPI  
135 mm



1/2  
**04-6138**  
GELPI  
175 mm



# Section - 05

  
*Splenor Surgicals*



**Pages 255-318**

- ★ Tracheotomy, Cardiovascular & Thoracic Surgery
- ★ Bone Punches & Rongeurs



# Tracheal Tubes with inner tubes

*Splenor Surgicals*

Fig.	0	1	2	3	4	5	6	7	8	9	10
$\varnothing$ mm	4	5	6	7	8	9	10	11	12	13	14
Charr./Fr.	12	15	18	21	24	27	30	33	36	39	42



**05-7001**  
UECKERMANN-DENKER  
Cryothyrotomy trocar  
with silver cannula  
130mm

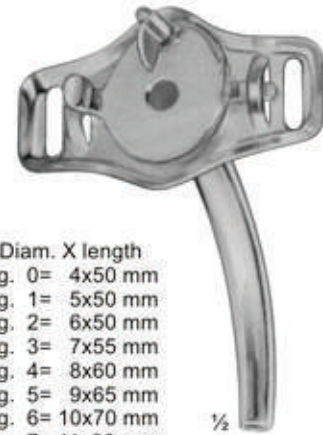

Diam. X length  
**05-7002** Fig. 0= 4x50 mm  
**05-7003** Fig. 1= 5x50 mm  
**05-7004** Fig. 2= 6x50 mm  
**05-7005** Fig. 3= 7x55 mm  
**05-7006** Fig. 4= 8x60 mm  
**05-7007** Fig. 5= 9x65 mm  
**05-7008** Fig. 6= 10x70 mm  
**05-7009** Fig. 7= 11x80 mm  
**05-7010** Fig. 8= 12x85 mm  
**05-7011** Fig. 9= 13x90 mm  
**05-7012** Fig. 10=14x90 mm

**05-7002 - 05-7012**  
LUER  
German silver



**05-7013 - 05-7022**  
JACKSON  
German Silver

Diam. X length  
**05-7013** Fig. 0= 4x50 mm  
**05-7014** Fig. 1= 5x48 mm  
**05-7015** Fig. 2= 6x58 mm  
**05-7016** Fig. 3= 7x70 mm  
**05-7017** Fig. 4= 8x78 mm  
**05-7018** Fig. 5= 9x84 mm  
**05-7019** Fig. 6= 10x84 mm  
**05-7020** Fig. 7= 11x86 mm  
**05-7021** Fig. 8= 12x88 mm  
**05-7022** Fig. 9= 13x90 mm



Diam. X length **05-7023 - 05-7032**  
**05-7023** Fig. 1= 5x48 mm JACKSON  
**05-7024** Fig. 2= 6x58 mm Stainless Steel  
**05-7025** Fig. 3= 7x70 mm  
**05-7026** Fig. 4= 8x78 mm  
**05-7027** Fig. 5= 9x84 mm  
**05-7028** Fig. 6= 10x84 mm  
**05-7029** Fig. 7= 11x86 mm  
**05-7030** Fig. 8= 12x88 mm  
**05-7031** Fig. 9= 13x90 mm  
**05-7032** Fig. 10= 14x90 mm



05-7033  
BOSE  
165 mm



05-7034  
BOSE  
165 mm



05-7035 - 05-7037  
180 mm



05-7035  
sharp



05-7036  
blunt



05-7037  
blunt



05-7038  
FINSEN  
50 mm



05-7039  
FINSEN  
70 mm



05-7040  
TROUSSEAU  
120 mm



05-7041  
LABORDE  
125 mm



05-7042  
LABORDE  
strong pattern  
135 mm



05-7043  
Cleaning Brush  
for tracheal tubes  
285 mm



# Irrigating Cannulae, Embolus Grasping Forceps, Dilators

*Splenor Surgicals*



**05-7044 - 05-7047**  
**SCHMID**  
 Vessel irrigating cannulae,  
 malleable, silver plated  
 150 mm



**05-7048**  
**BLAKE**  
 Embolus grasping  
 forceps  
 205 mm

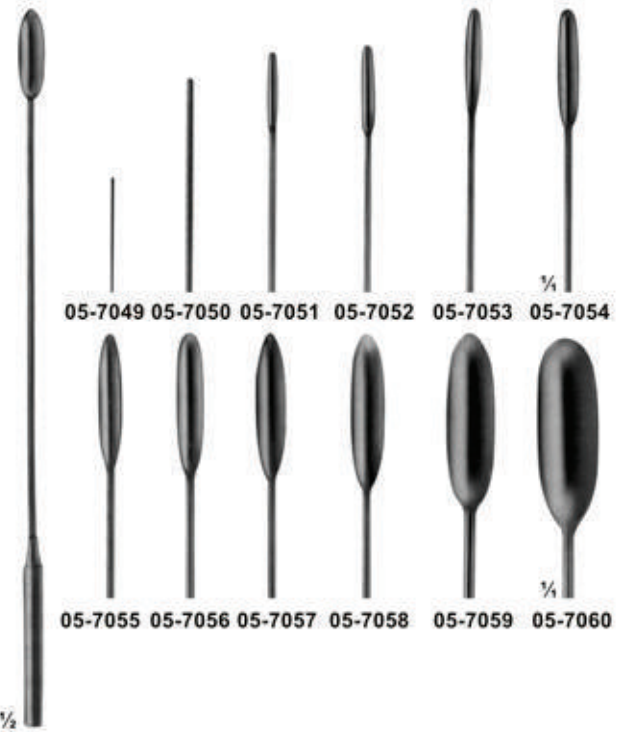

**05-7049 - 05-7060**  
**DE BAKELY**  
 Vascular dilators,  
 malleable  
 190 mm

<b>05-7049</b>	0,5 mm Ø	<b>05-7055</b>	3,5 mm Ø
<b>05-7050</b>	1,0 mm Ø	<b>05-7056</b>	4,0 mm Ø
<b>05-7051</b>	1,5 mm Ø	<b>05-7057</b>	4,5 mm Ø
<b>05-7052</b>	2,0 mm Ø	<b>05-7058</b>	5,0 mm Ø
<b>05-7053</b>	2,5 mm Ø	<b>05-7059</b>	7,0 mm Ø
<b>05-7054</b>	3,0 mm Ø	<b>05-7060</b>	9,0 mm Ø

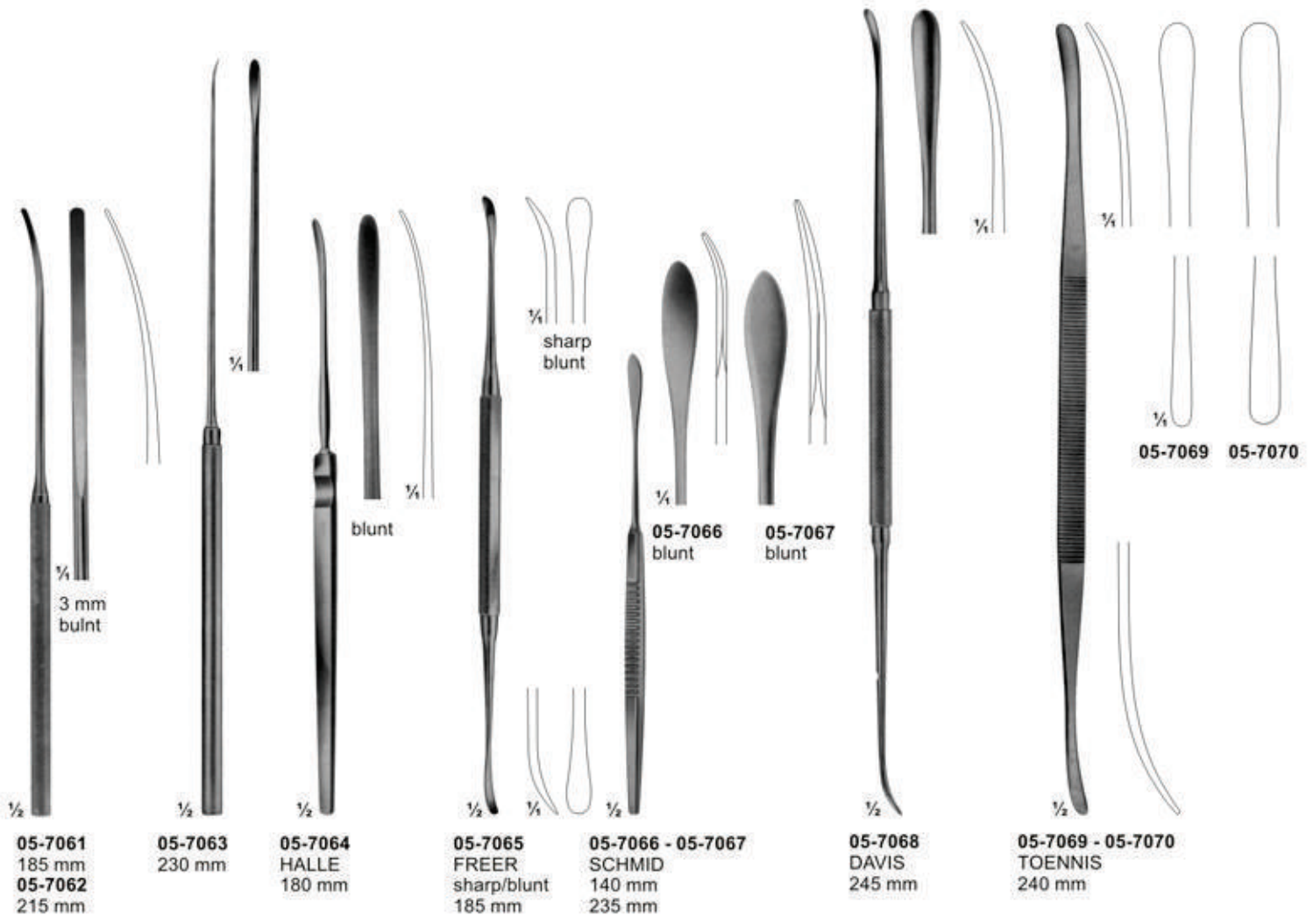



# Endarterectomy Strippers, Tourniquets

*Splenor Surgicals*

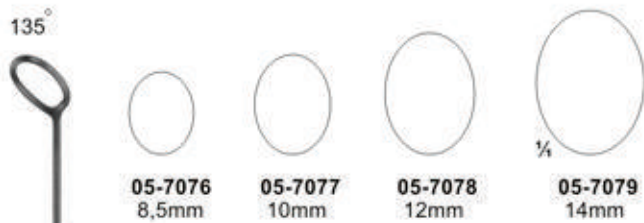
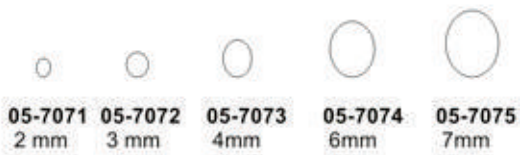



# Bioptome and Aortic Dilators

*Splenor Surgicals*

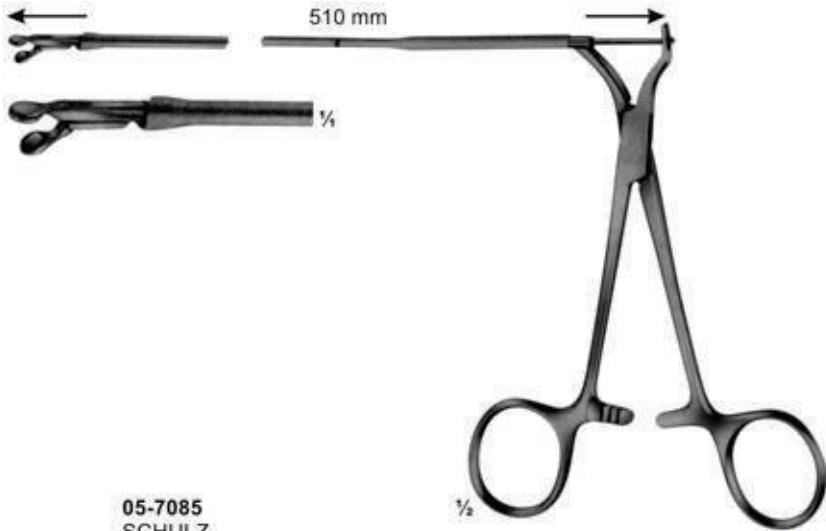

**05-7085  
SCHULZ**  
Bioptome, with flexible Shaft, 510 mm long,  
with round jaws 3 mm diam.  
  
Biopsy forceps, for biopsy from the right atrium  
through cava jugularis, prior to heart implantations.

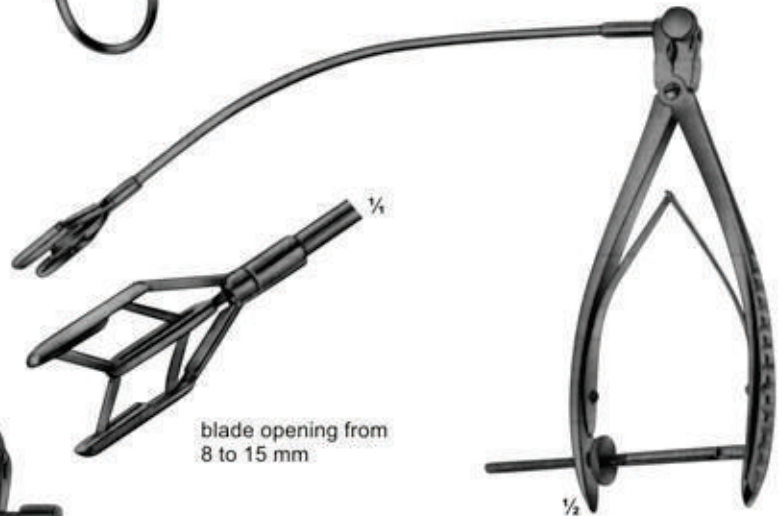

**05-7087  
COOLEY**  
Dilator for  
mitral valve  
for children

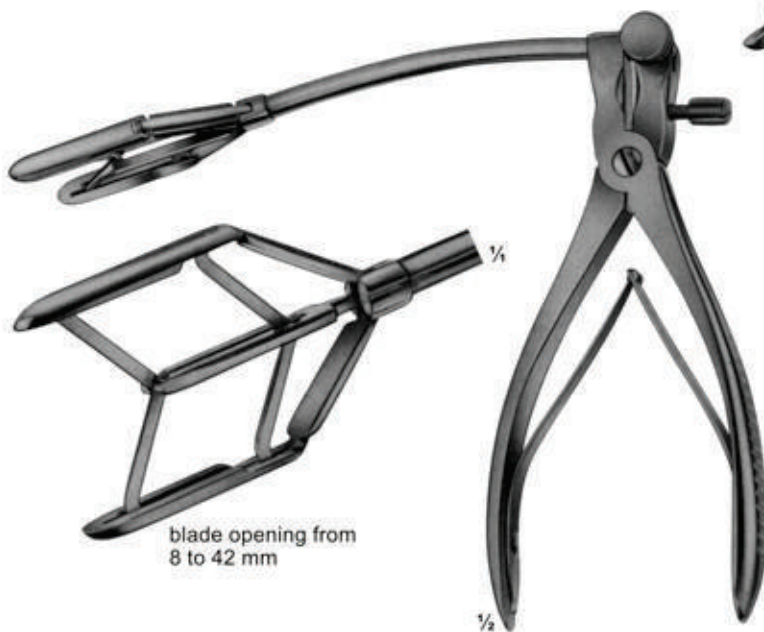

**05-7086  
TUBBS**  
Dilator for  
mitral valve

blade opening from  
8 to 15 mm

blade opening from  
8 to 42 mm



# JENKER Instrument Set For Tunnelling And Pulling-Through Vascular Grafts Toothings

*Splenor Surgicals*

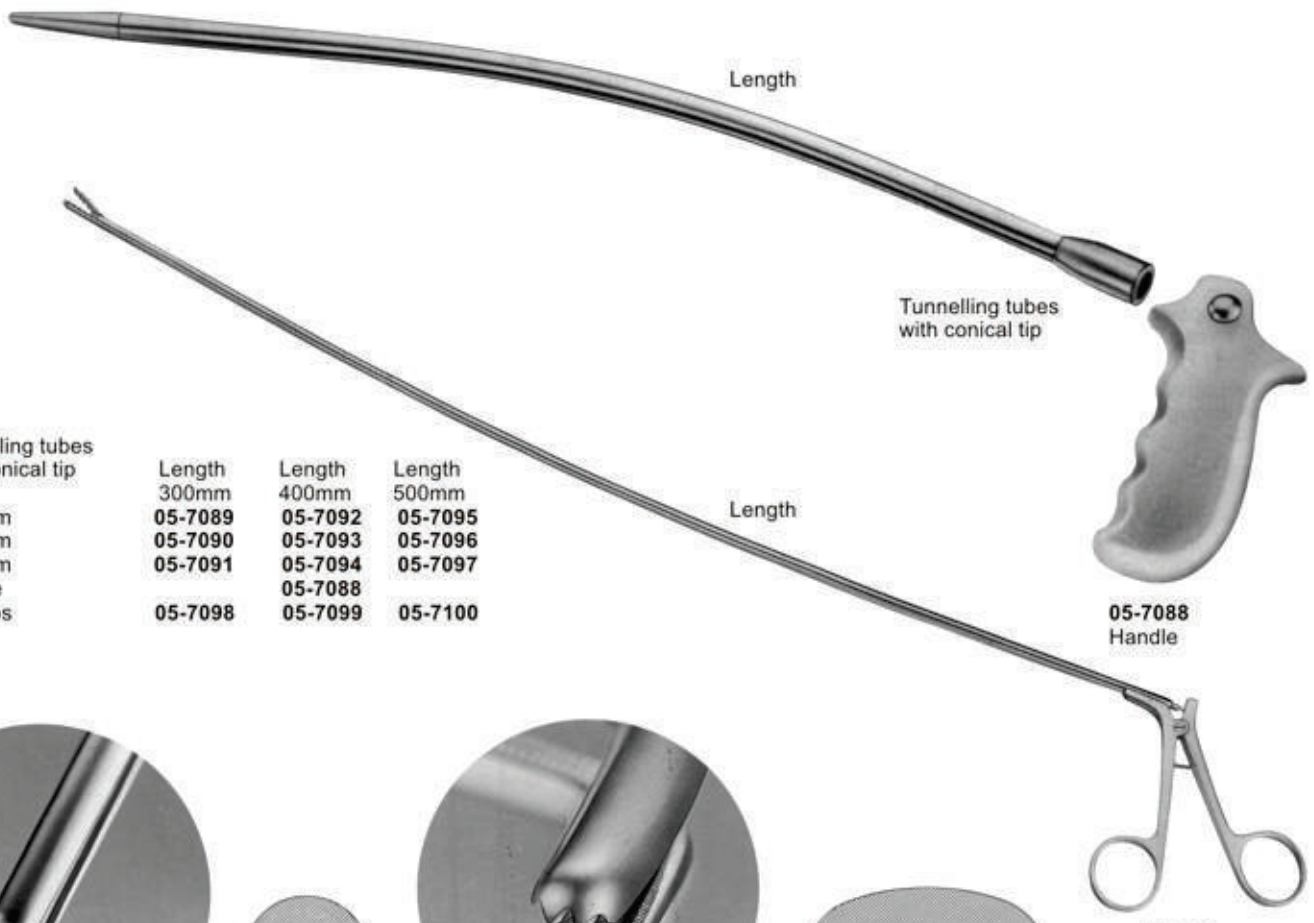

Tunnelling tubes with conical tip

	Length 300mm	Length 400mm	Length 500mm
∅ 12mm	05-7089	05-7092	05-7095
∅ 14mm	05-7090	05-7093	05-7096
∅ 17mm	05-7091	05-7094	05-7097
Handle	05-7098	05-7099	05-7100

Tunnelling tubes with conical tip

05-7088 Handle

05-7098 Forceps



**DE BAKEY**  
05-7101  
1 : 2 rows of teeth

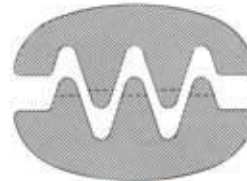

**DE BAKEY**  
05-7102  
2 : 3 rows of teeth

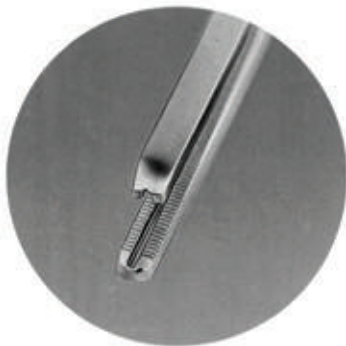

**COOLEY**  
05-7103  
2 : 2 rows of teeth

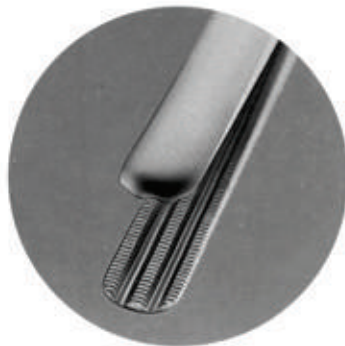

**DARDIK**  
05-7104  
2 : 3 rows of teeth





**05-7105**  
Width of jaws 1.2 mm  
Length 150mm

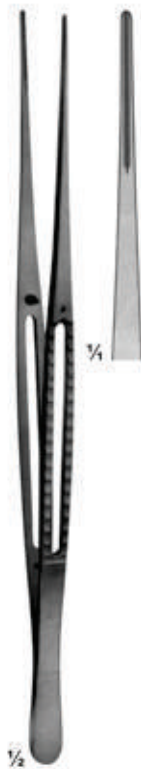

**05-7106**  
Width 1,5 mm  
Lenght 200 mm



**05-7107**  
Width 1,5 mm  
Lenght 240 mm



**05-7108**  
Width 1,5 mm  
Lenght 300 mm



# Atraumata Dissecting Forceps

Splenor Surgicals

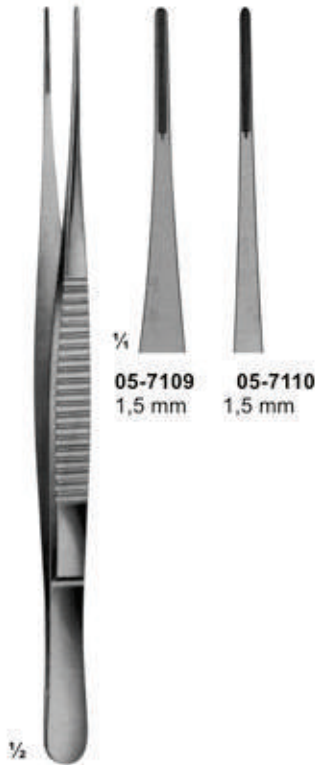

¼  
05-7109 1,5 mm  
05-7110 1,5 mm

½  
05-7109 - 05-7110  
DE BAKEY  
150 mm  
300 mm

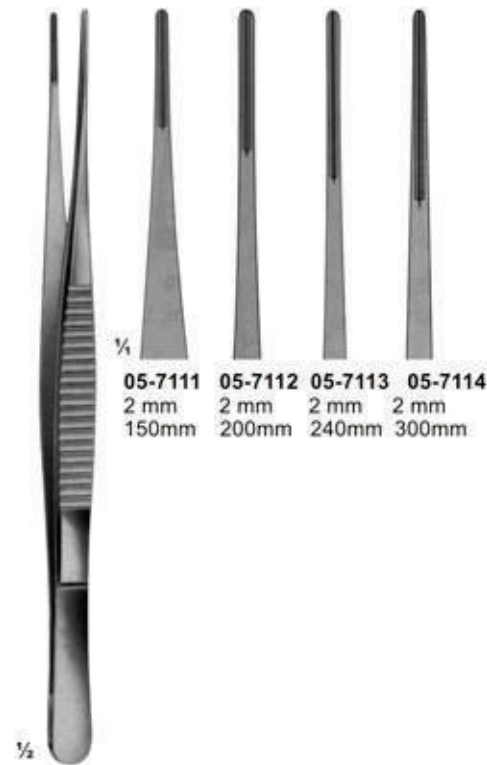

¼  
05-7111 2 mm  
05-7112 2 mm  
05-7113 2 mm  
05-7114 2 mm  
150mm 200mm 240mm 300mm

½  
05-7111 - 05-7114  
DE BAKEY

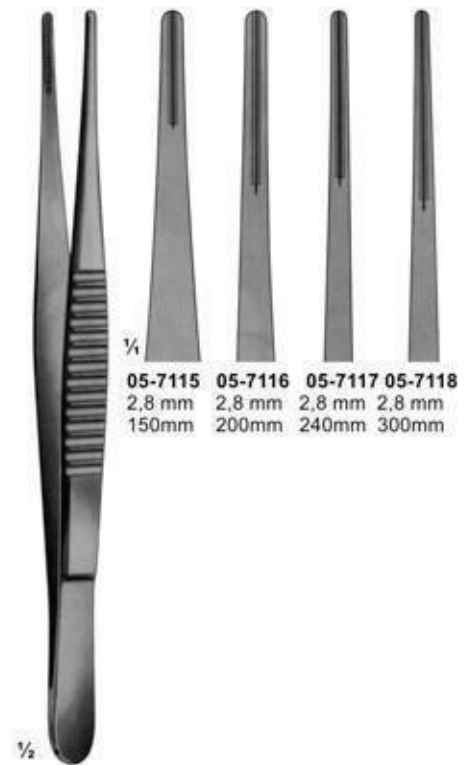

¼  
05-7115 2,8 mm  
05-7116 2,8 mm  
05-7117 2,8 mm  
05-7118 2,8 mm  
150mm 200mm 240mm 300mm

½  
05-7115 - 05-7118  
DE BAKEY

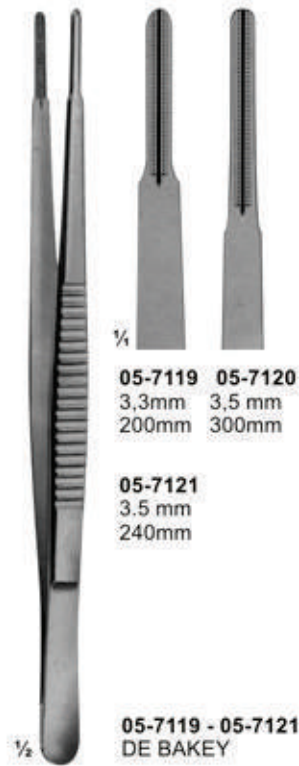

¼  
05-7119 3,3mm  
05-7120 3,5 mm  
200mm 300mm

05-7121  
3,5 mm  
240mm

½  
05-7119 - 05-7121  
DE BAKEY



¼  
05-7122  
2 mm  
40°

½  
05-7122  
DE BAKEY  
150 mm



¼  
05-7123  
2 mm  
40°

½  
05-7123  
DE BAKEY  
200 mm



# Atraumata Ring Handle Bulldog Clamps

*Splenor Surgicals*

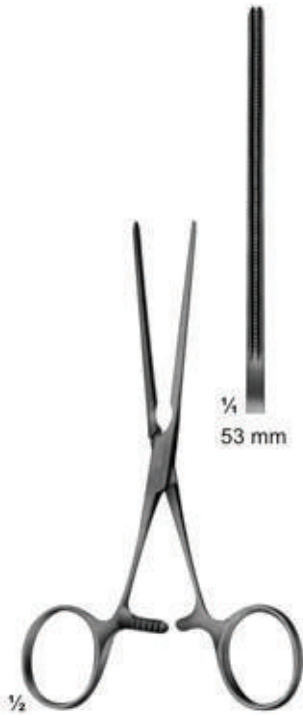

**05-7124**  
DE-BAKEY  
straight  
130 mm



**05-7125**  
DE-BAKEY  
curved jaws  
125 mm

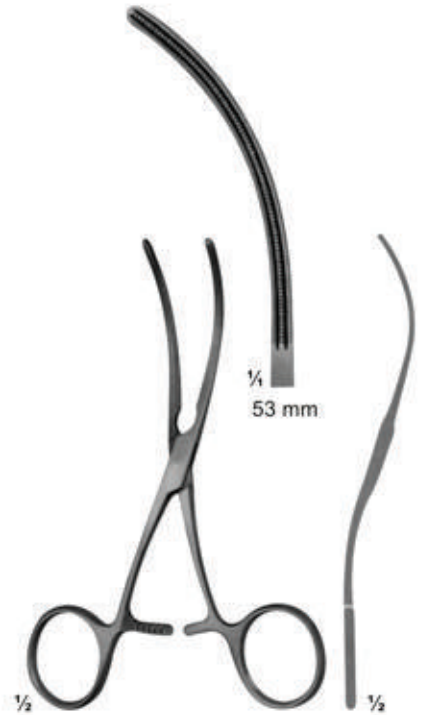

**05-7126**  
DE-BAKEY  
S-shaped curved  
125 mm

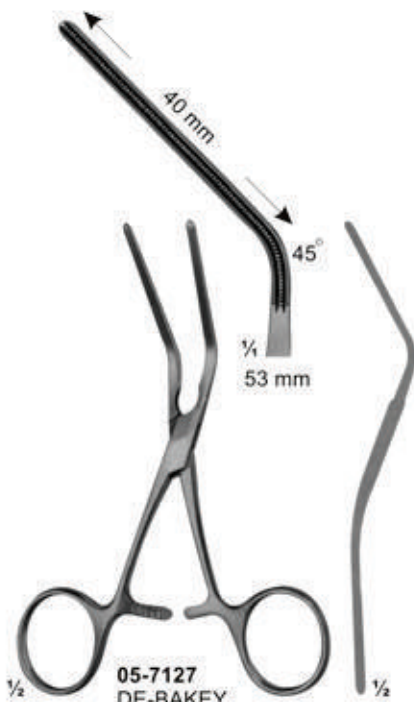

**05-7127**  
DE-BAKEY  
angled 45  
125 mm



**05-7128**  
DE-BAKEY  
angled 90  
105 mm



# Atraumata Anastomosis and Multi-Purpose-Clamps for Neonatales

*Splenor Surgicals*

graduated



05-7129 - 05-7132  
CASTANEDA



90°  
¼  
48 mm  
05-7129  
Length 105 mm

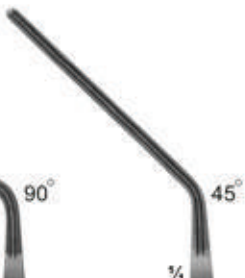

45°  
¼  
48 mm  
05-7130  
Length 120 mm



30°  
¼  
48 mm  
05-7131  
Length 120 mm



¼  
48 mm  
05-7132  
Length 125 mm

graduated



05-7133 - 05-7136  
CASTANEDA



15 mm  
¼  
48 mm  
05-7133  
Length 155 mm

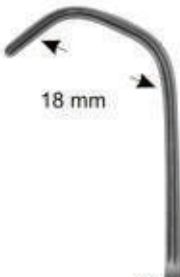

18 mm  
¼  
52 mm  
05-7134  
Length 155 mm



23 mm  
¼  
56 mm  
05-7135  
Length 155 mm

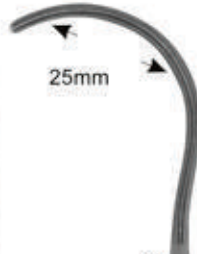

25 mm  
¼  
50 mm  
05-7136  
Length 155 mm



# Atraumata Anastomosis-and Multi-Purpose Clamps-Pediatric types

*Splenor Surgicals*

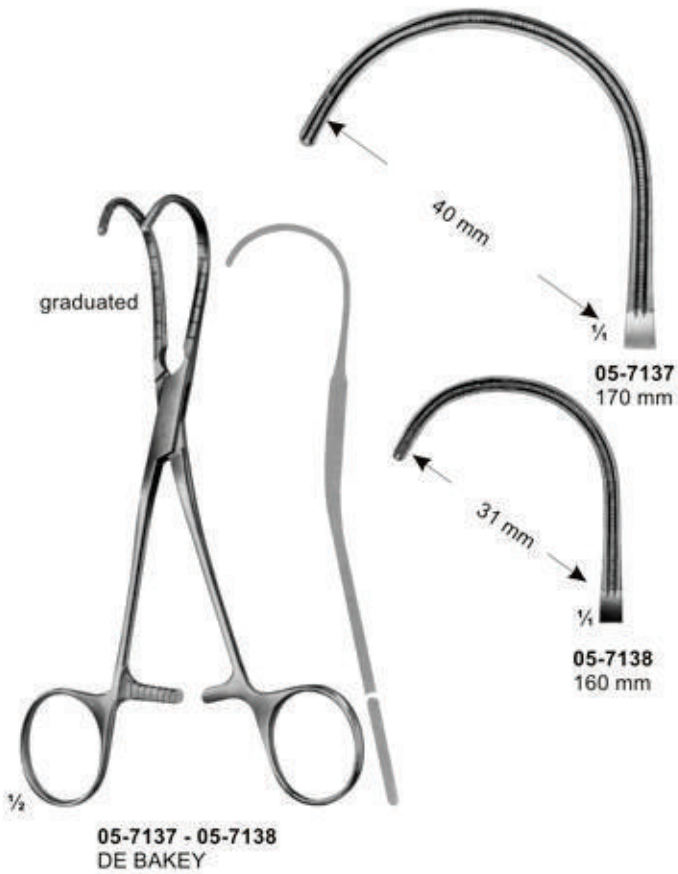

# Atraumata Non-traumatic Haemostatic Forceps

## Mosquito Forceps

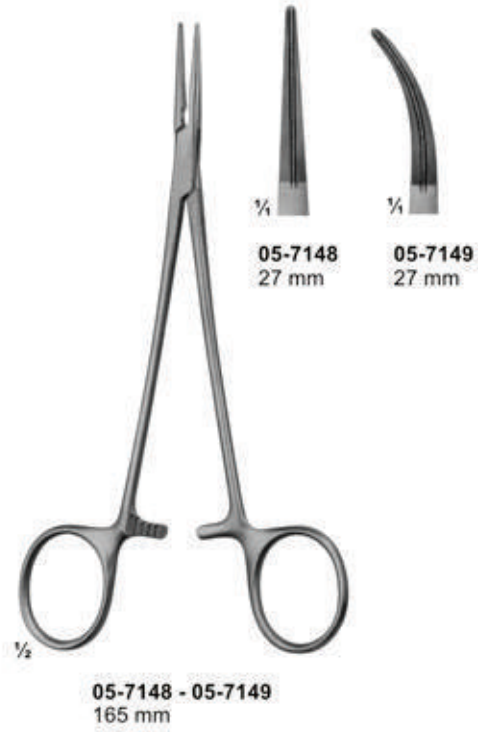



# Atraumata Non-traumatic Haemostatic Forceps

Splenor Surgicals

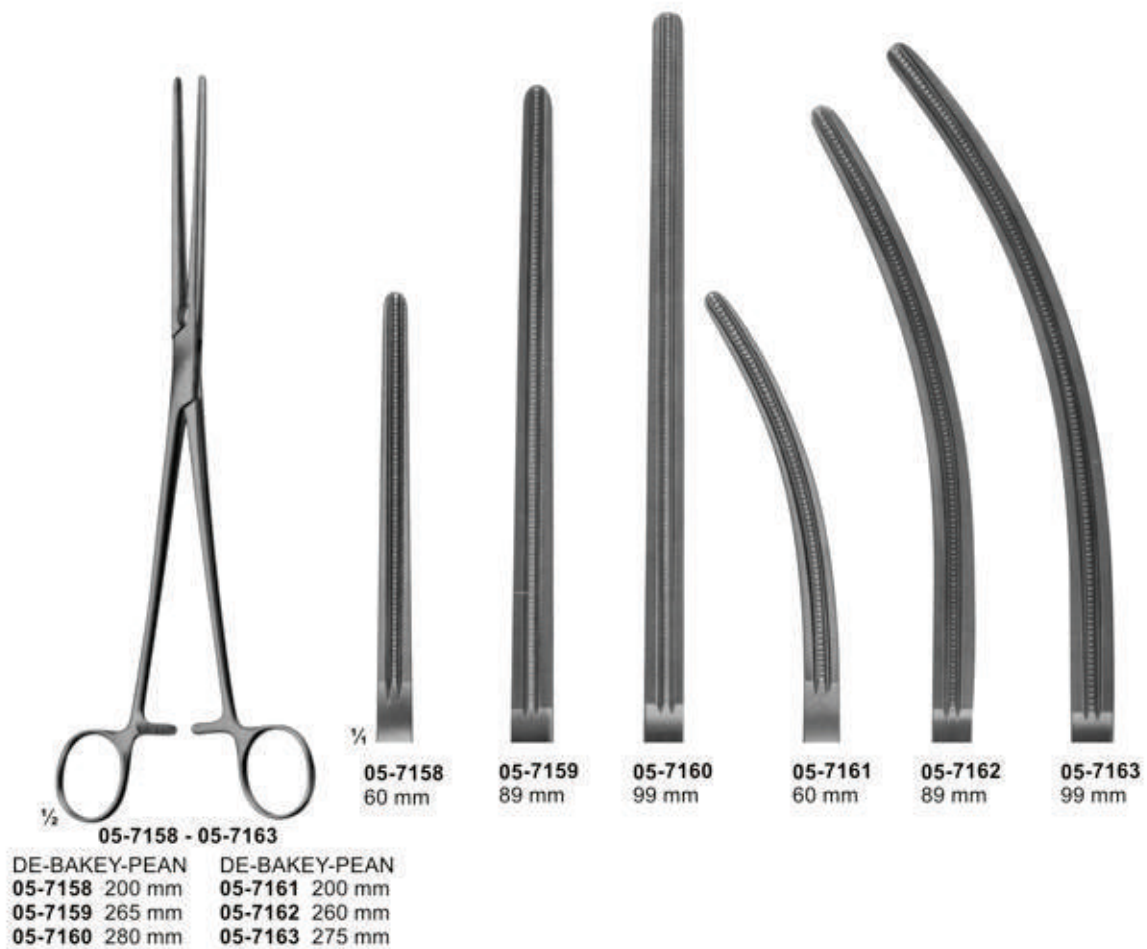



# Atraumata Dissecting And Ligature Forceps Anastomosis Clamps

*Splenor Surgicals*

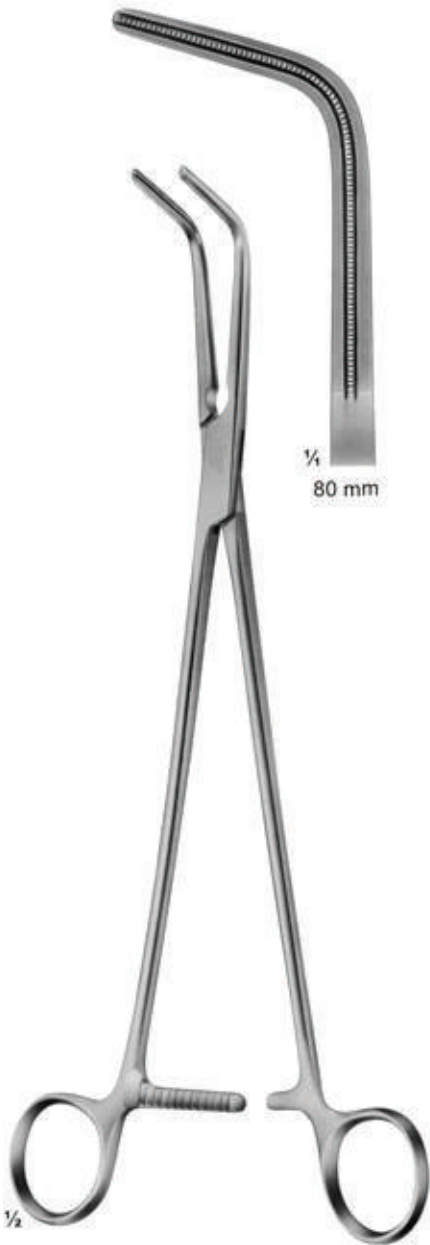

**05-7164**  
DE-BAKEY-MIXTER  
285 mm

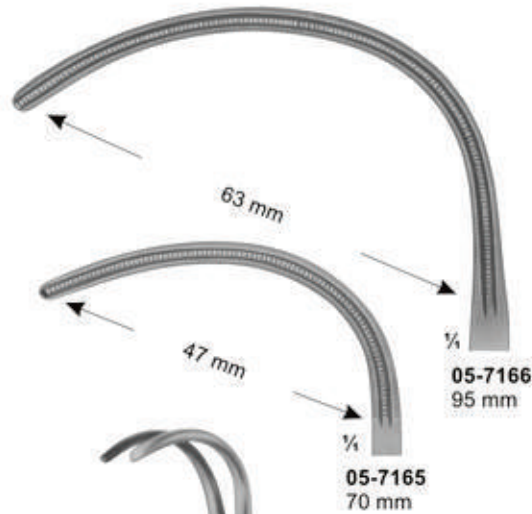

**05-7165 - 05-7166**  
GLOVER  
05-7165 195mm  
05-7166 210mm



**05-7167**  
GLOVER  
220 mm





# Atraumata Anastomosis, Vena-Cava Clamps

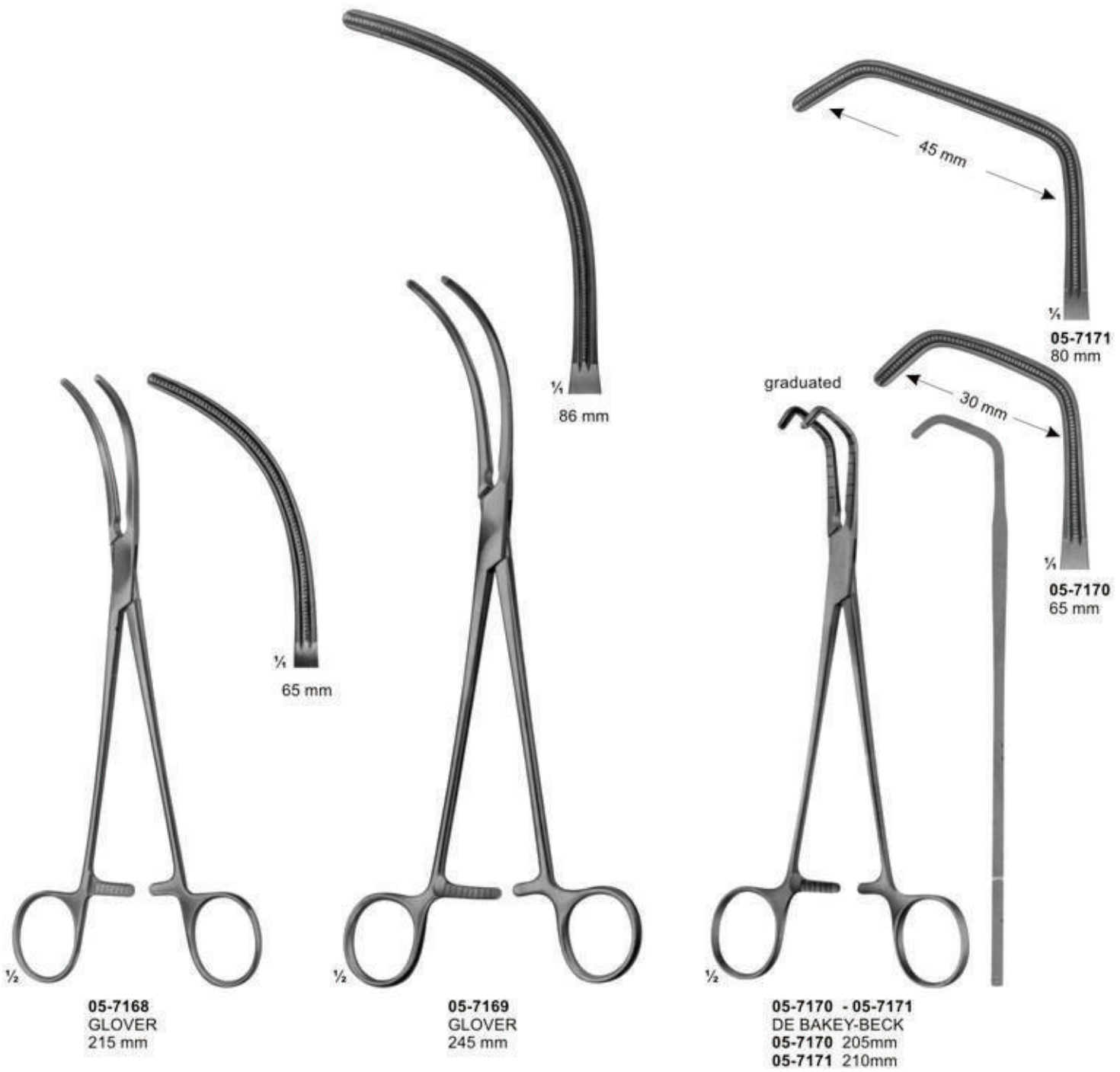



# Atraumata Vena-Cava Clamps And Tangential Occlusion Clamps

*Splenor Surgicals*



05-7172 - 05-7175  
DE BAKY-HARKEN  
05-7172 - 255 mm  
05-7173 - 245 mm  
05-7174 - 245 mm  
05-7175 - 245 mm



Total Length: 220 mm  
Length of jaws: 85 mm

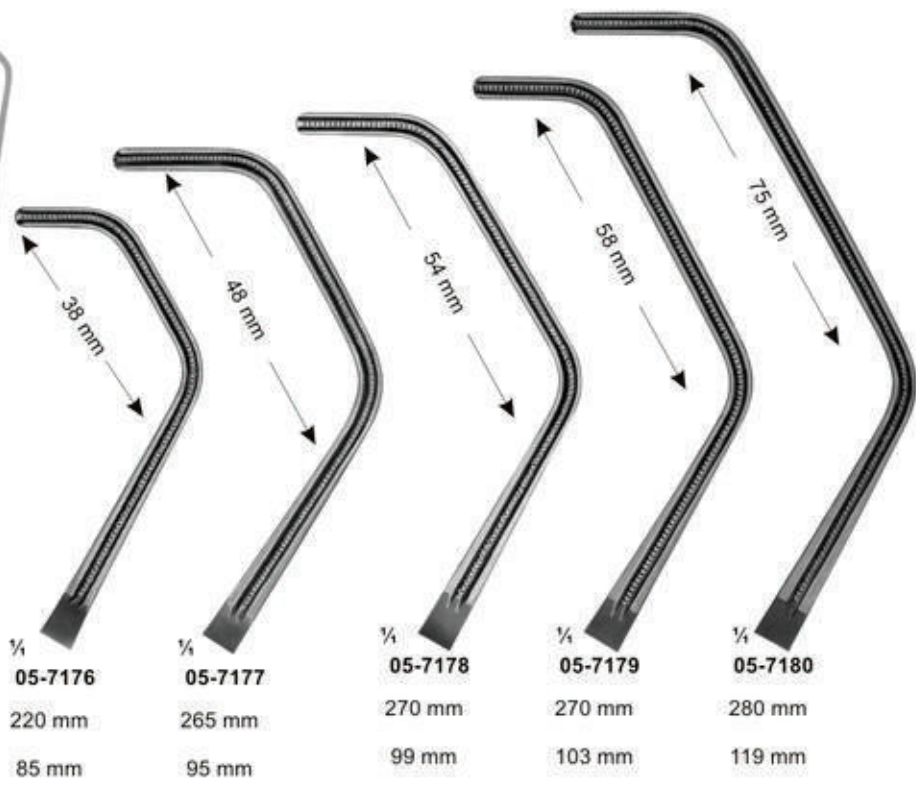



# Atraumata Tangential Occlusion And Coarctation Clamps

*Splenor Surgicals*



graduated

1/2

**05-7181 - 05-7183**  
DE BAKEY-SATINSKY

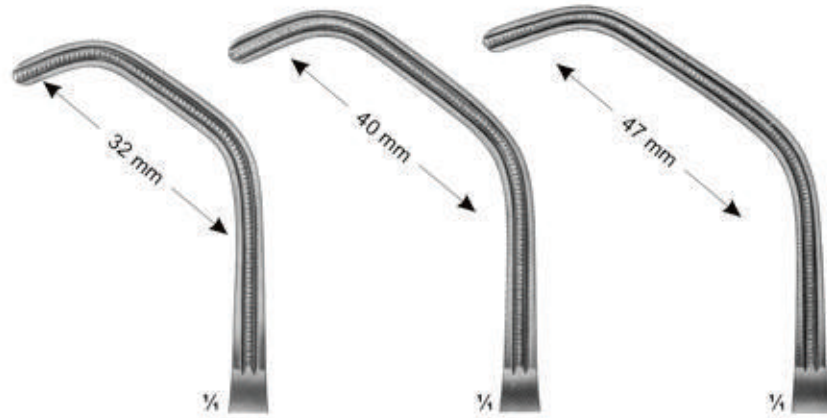

32 mm

40 mm

47 mm

1/4

1/4

1/4

**05-7181**  
68 mm  
Length 235mm

**05-7182**  
76 mm  
Length 240mm

**05-7183**  
84 mm  
Length 245mm



1/2

**05-7184 - 05-7185**  
DE BAKEY  
05-7184 170mm  
05-7185 165mm



1/4

1/4

**05-7184**  
50 mm

**05-7185**  
50 mm

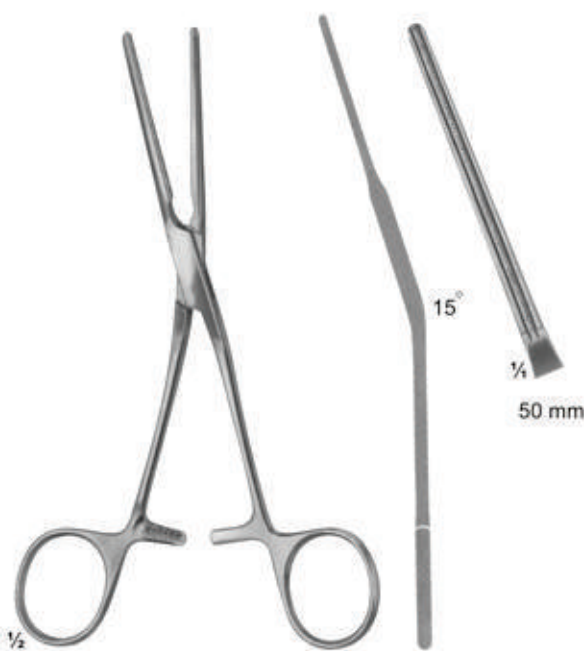

1/2

**05-7186**  
DE BAKEY  
165 mm

15°

1/4

50 mm



# Atraumata Coarctation Clamps, Patent-Ducts Clamps

*Splenor Surgicals*





# Atraumata Peripheral-Vascular Clamps

## Splenor Surgicals

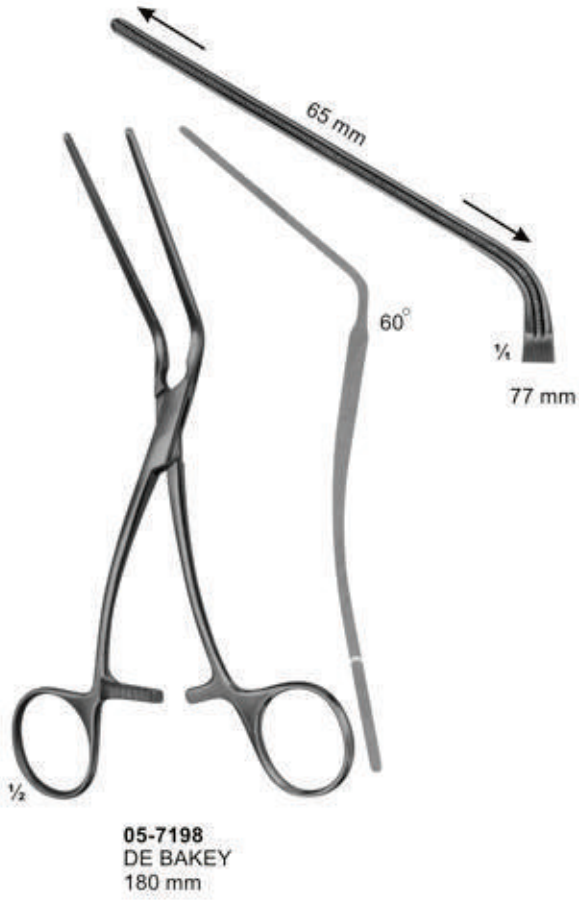

# Atraumata Peripheral Vascular And Anastomosis Clamps



# Atraumata Anastomosis And Ascending Aorta Cross Clamps



05-7204 - 05-7206  
DICK  
05-7204 255mm  
05-7205 265mm  
05-7206 275mm



05-7207  
MORRIS  
175 mm



# Atraumata Ascending Aorta Cross, Bronchus Clamps

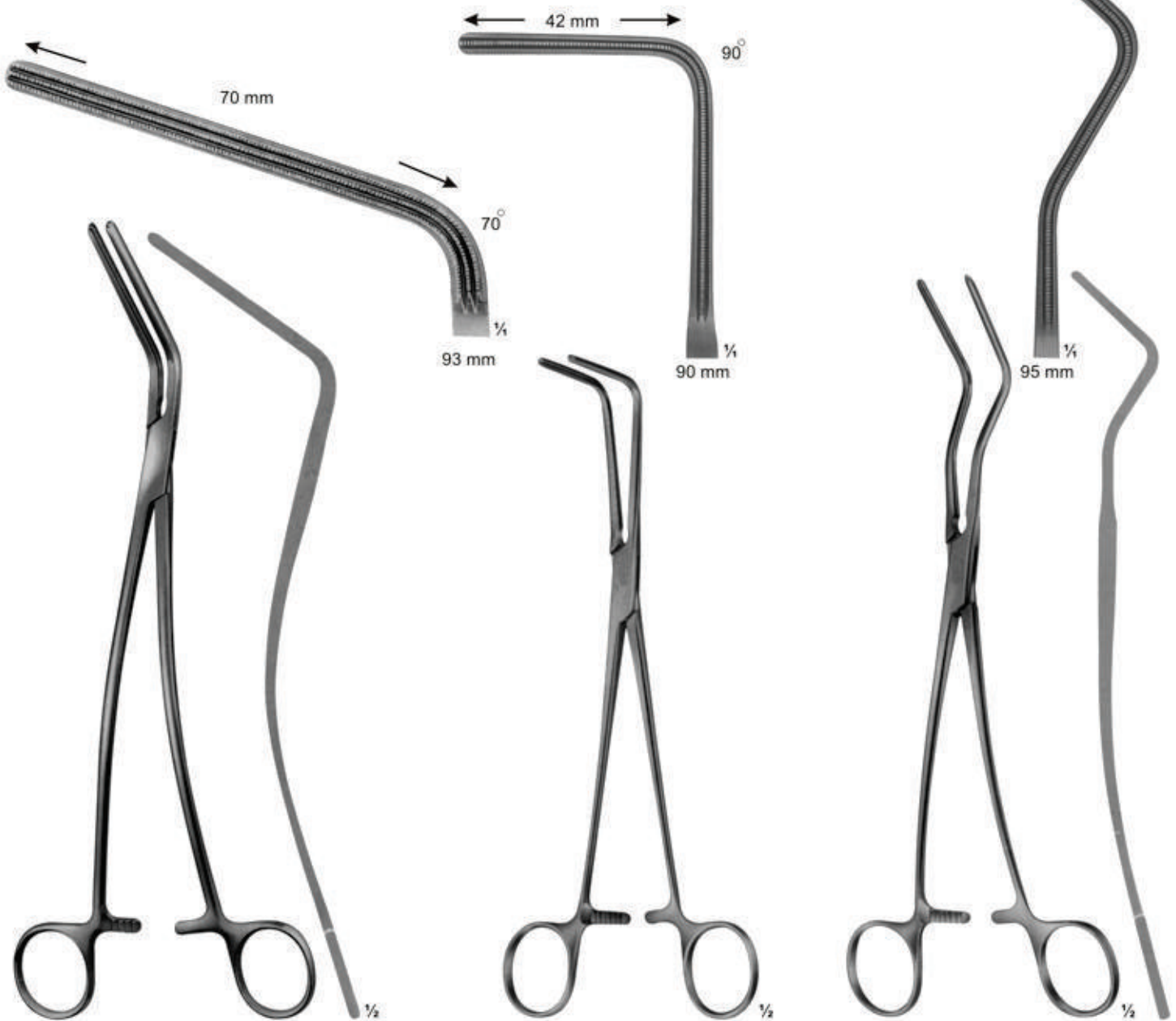

05-7208  
DE BAKEY(Morris Modif)  
240 mm

05-7209  
LEES  
220 mm

05-7210  
LEES  
245 mm



# Atraumata Aorta-Aneurysm Clamps

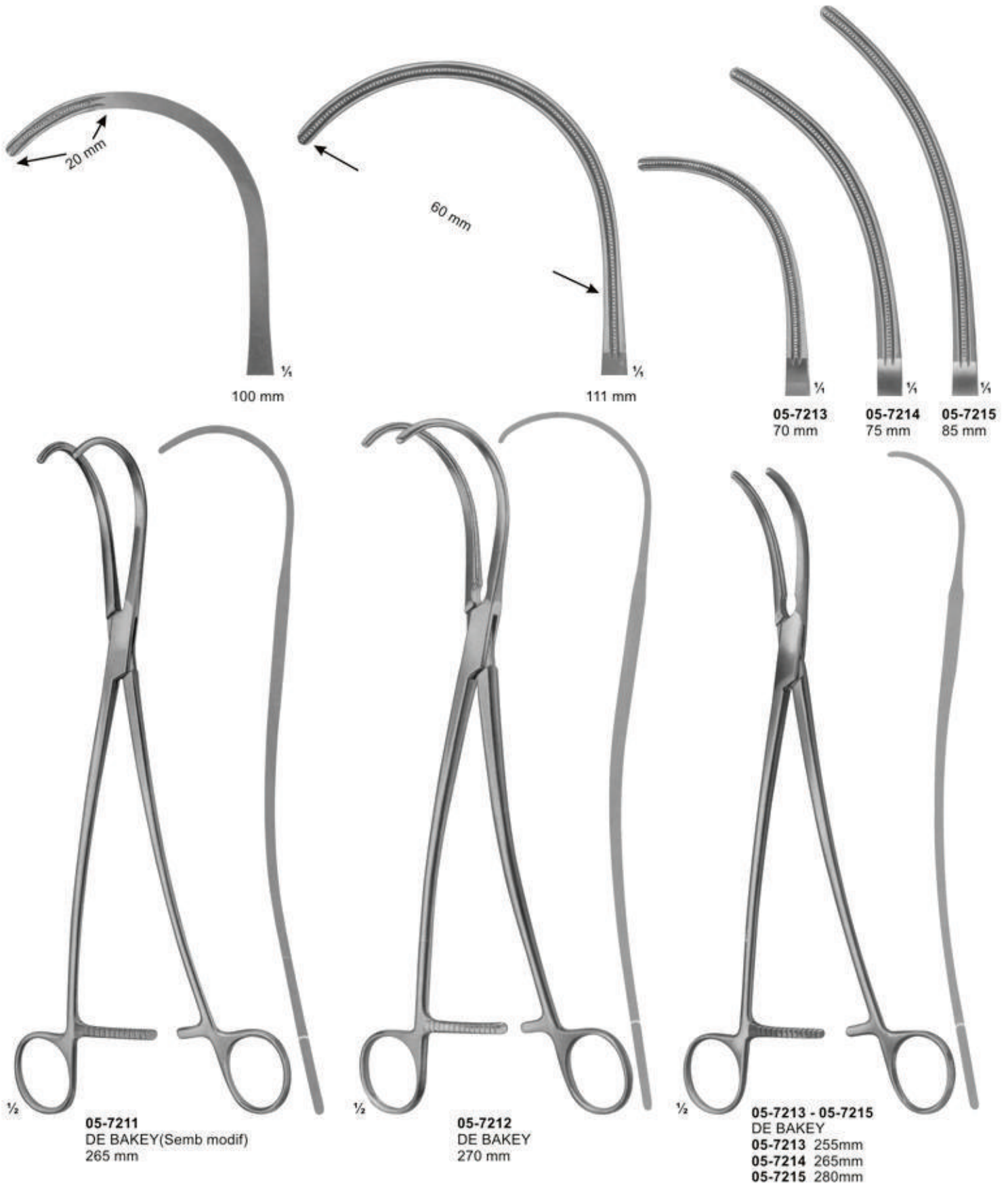

# Atraumata Aorta-Aneurysm Clamps



2.3 Teeth Rows



05-7216 05-7217 05-7218 05-7219  
95 mm 110 mm 130 mm 140 mm

05-7216 - 05-7219  
DE BAKY  
05-7216 250mm  
05-7217 300mm  
07-7218 315mm  
07-7219 330mm



05-7220  
DE BAKY  
300 mm



# Atraumata Aorta Clamps

*Splenor Surgicals*

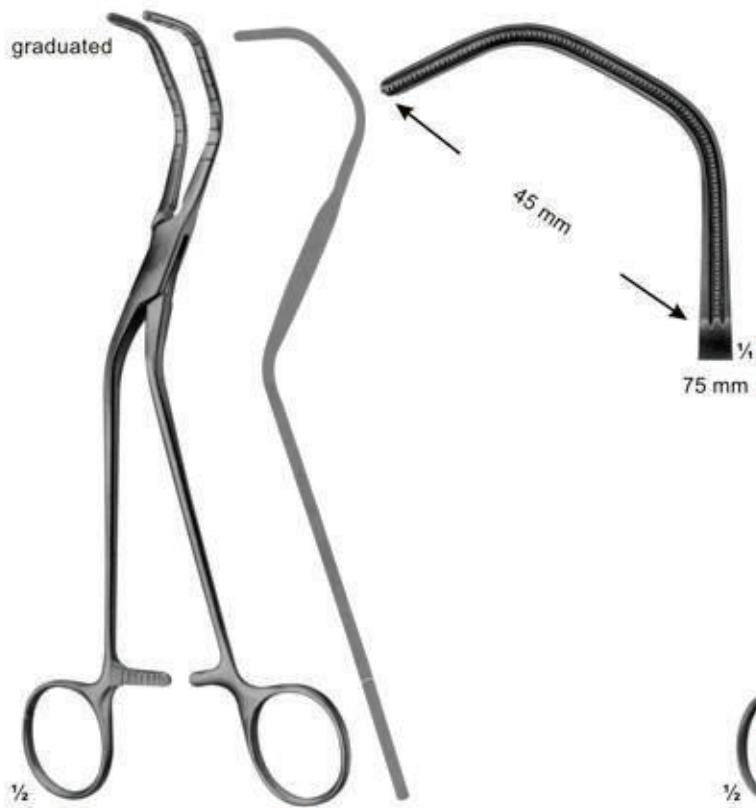

**05-7221**  
DIETRICH  
210 mm

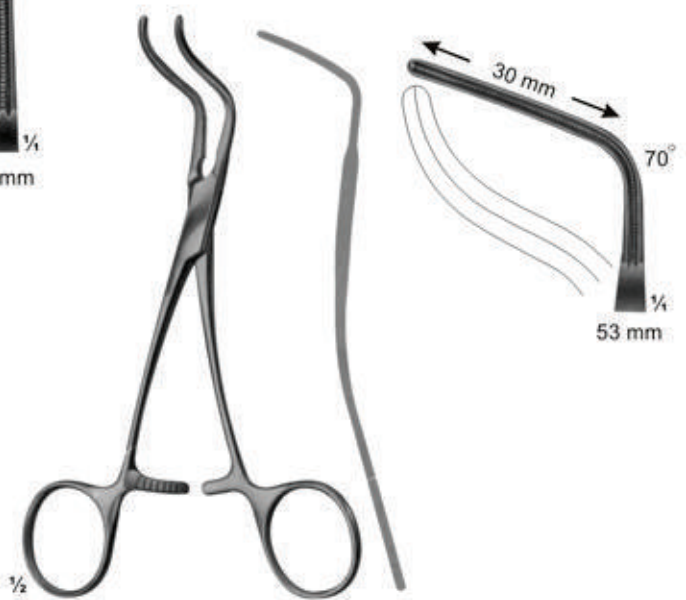

**05-7222**  
SUBRAMANIAN (Modif)  
155 mm



# Atraumata Aorta Clamps

*Splenor Surgicals*

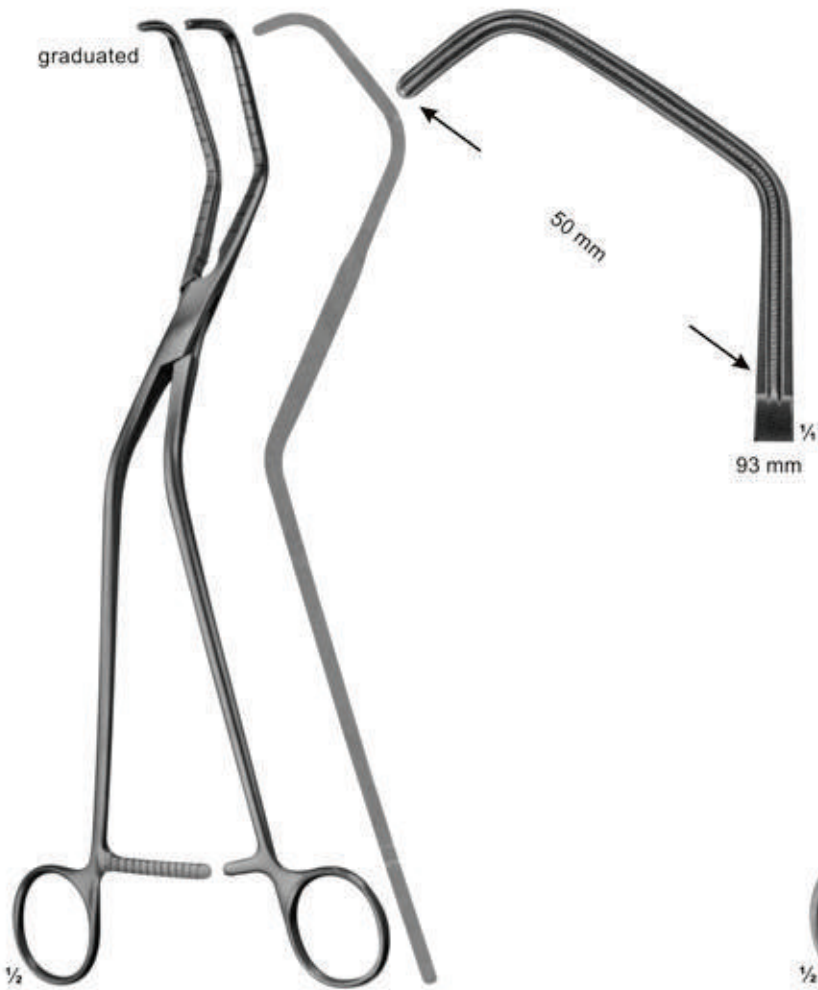

**05-7223**  
OCHSNER  
260 mm



**05-7224**  
DE BAKAY  
265 mm



L  
05-7225  
WEBER  
260 mm



R  
05-7226  
WEBER  
260 mm



# Multi-Purpose Clamps

*Splenor Surgicals*



½ 05-7227 - 05-7230  
DE BAKEY

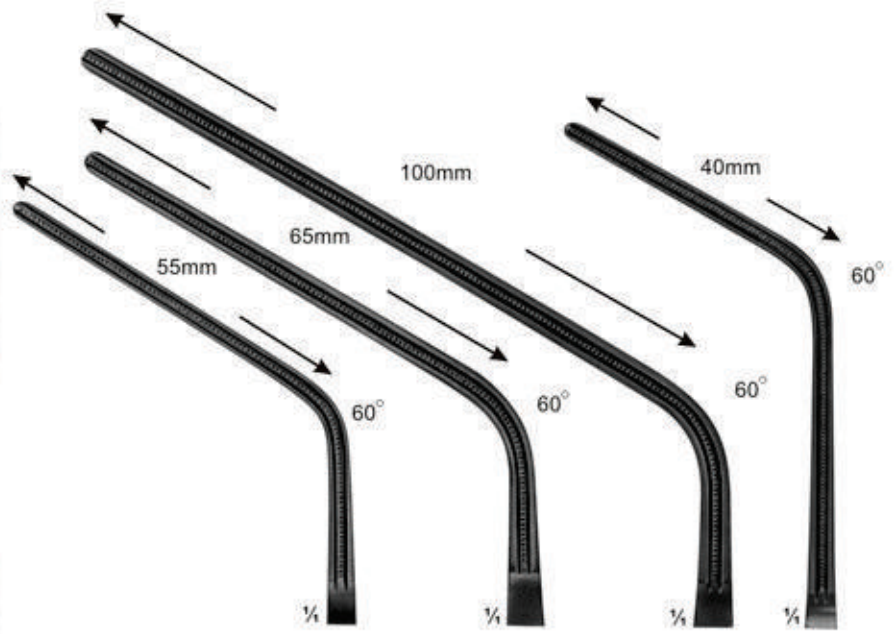

05-7227      05-7228      05-7229      05-7230

Total Length:	230 mm	280 mm	305 mm	240 mm
Length of jaws:	85 mm	100 mm	135 mm	93 mm



½ 05-7231 - 05-7234  
DE BAKEY

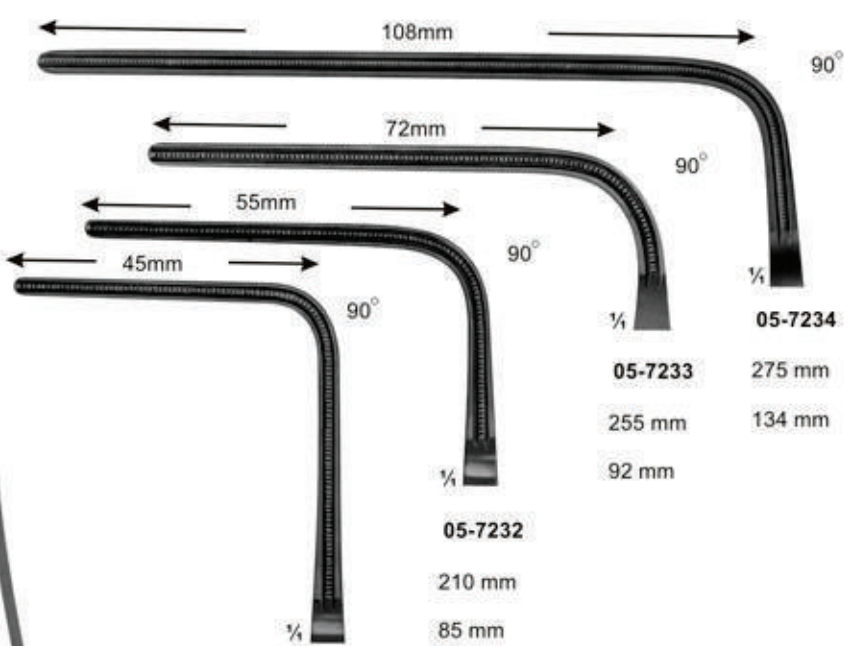

05-7231      05-7232      05-7233      05-7234

Total Length:	225 mm	210 mm	255 mm	275 mm
Length of jaws:	93 mm	85 mm	92 mm	134 mm



# Ring Handle Bulldog Clamps Anastomosis Clamps, Pediatric Types

*Splenor Surgicals*



05-7235  
50mm



05-7236  
50mm

05-7235 - 05-7236  
COOLEY  
125 mm, 115 mm



05-7237  
COOLEY  
100 mm



05-7238  
COOLEY  
125 mm

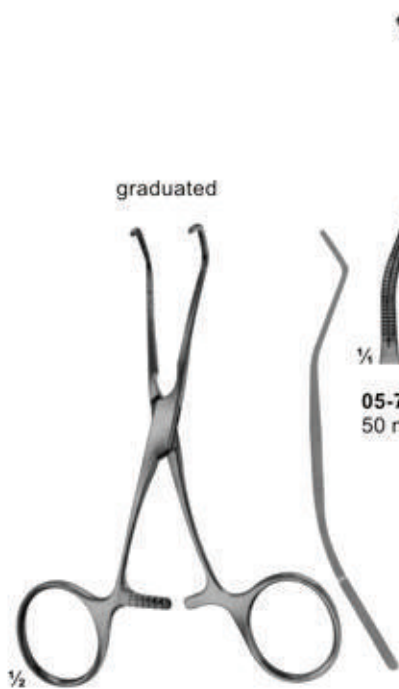

05-7239 - 05-7240  
COOLEY  
120 mm, 115 mm

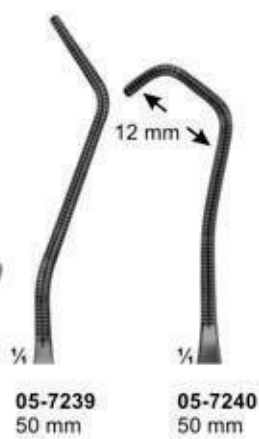

05-7239  
50 mm



05-7241 - 05-7242  
COOLEY-BECK  
150 mm, 155 mm

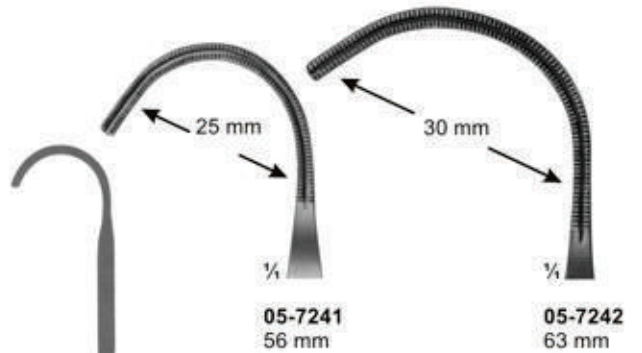

05-7241  
56 mm

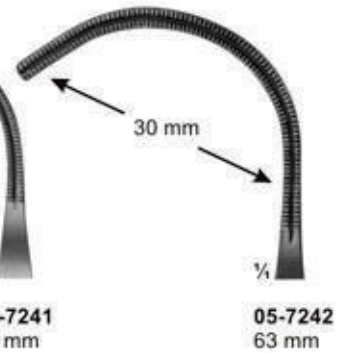

05-7242  
63 mm



# Anastomosis Clamps, Pediatric Types

*Splenor Surgicals*

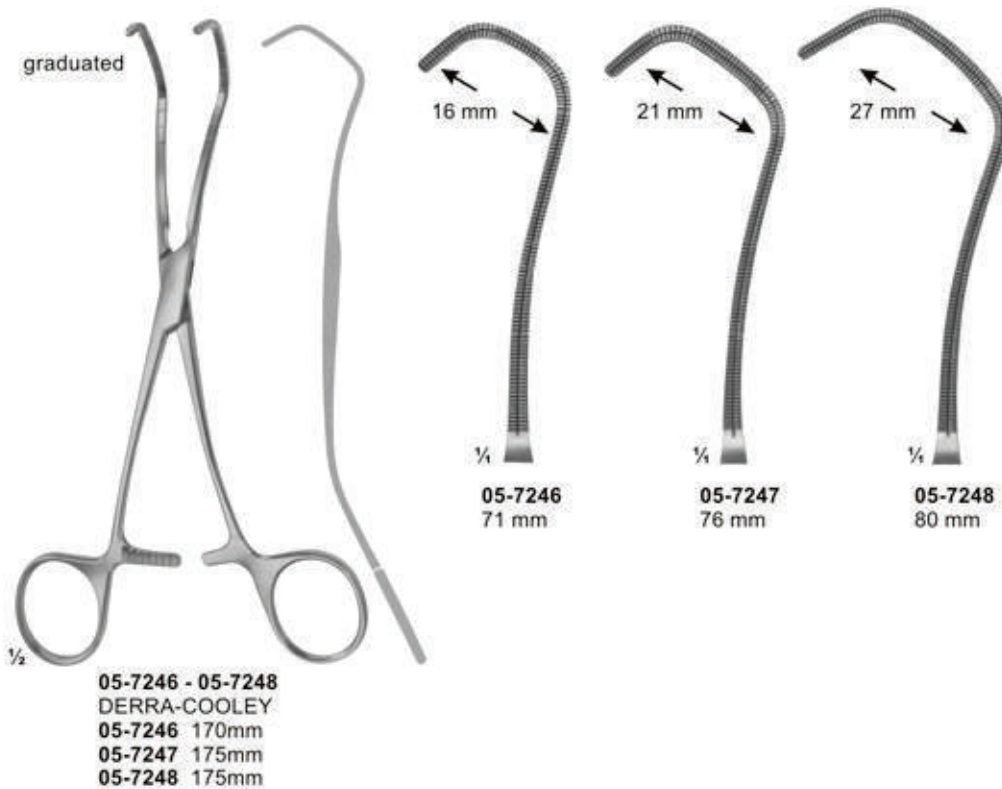
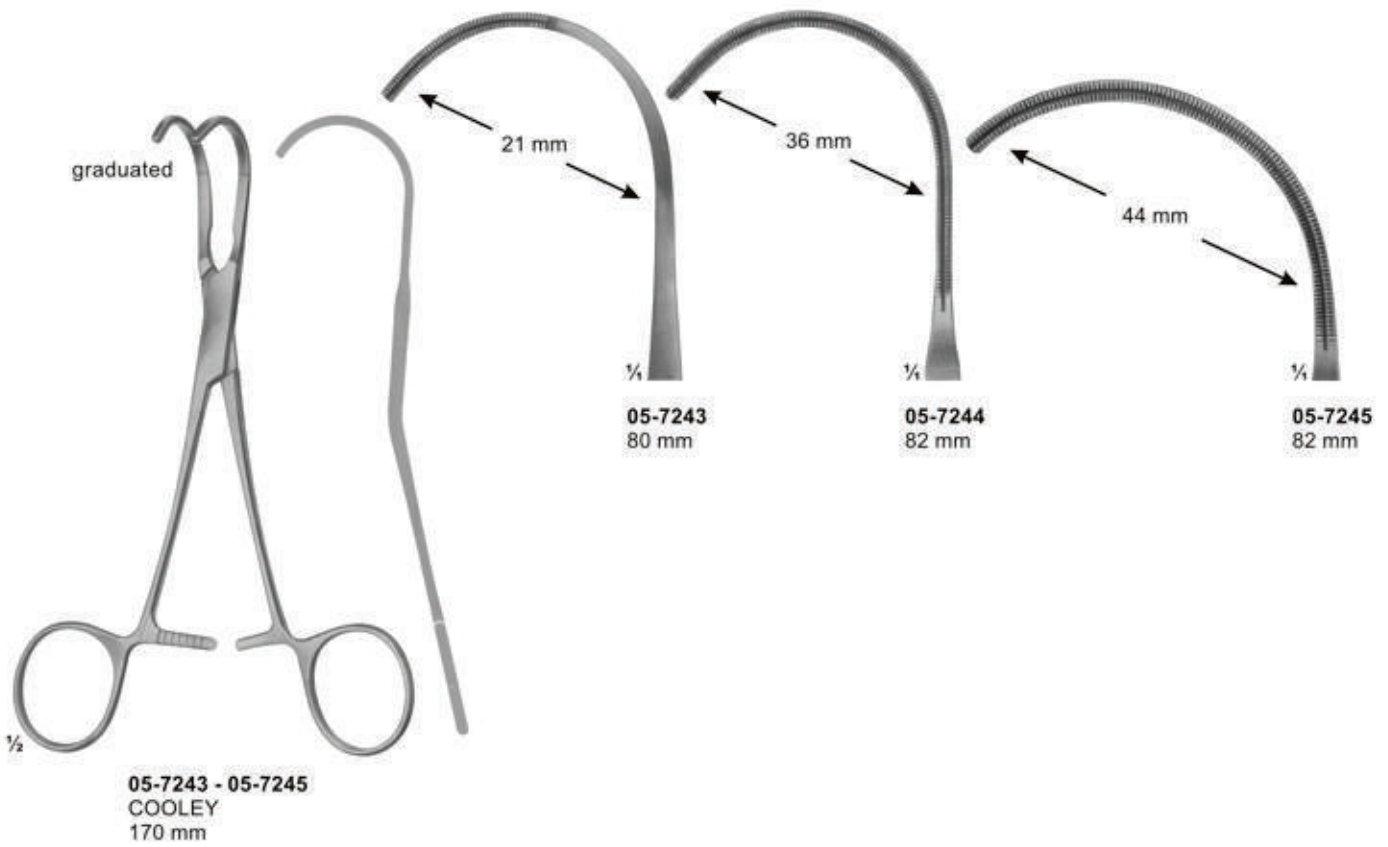





# Anastomosis Clamps Multi-Purpose Clamps Pediatric Types

*Splenor Surgicals*

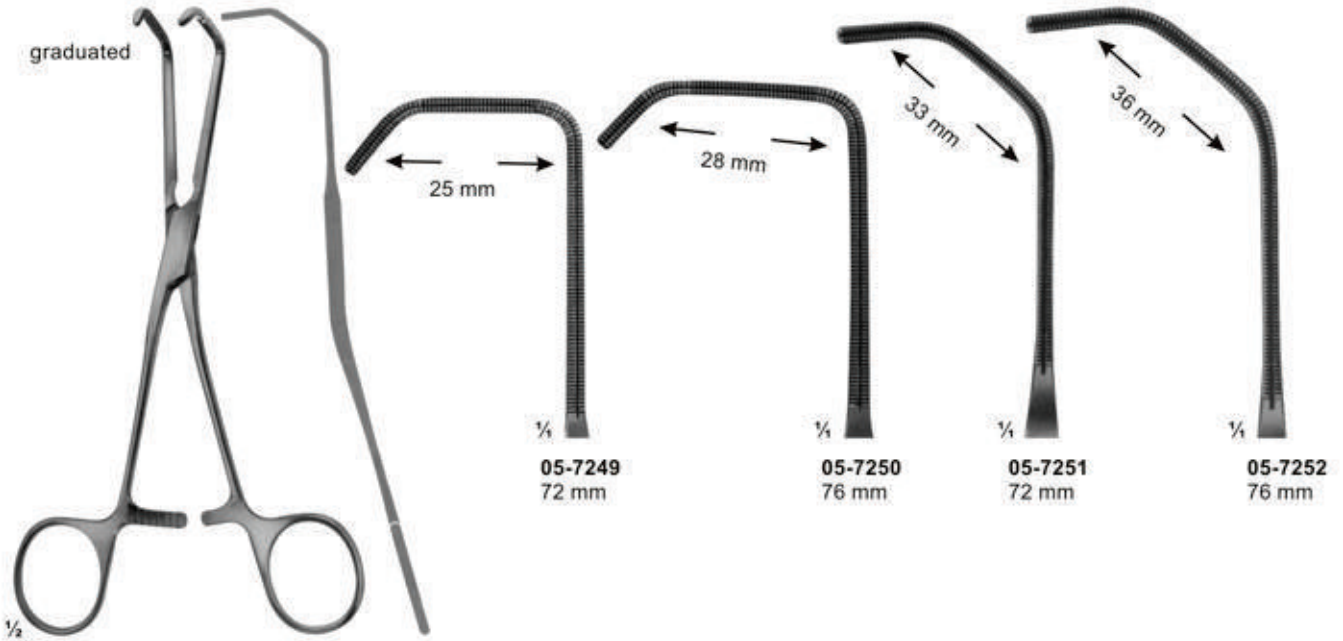

05-7249 - 05-7252  
COOLEY  
05-7249 165mm  
05-7250 165mm  
05-7251 175mm  
05-7252 180mm

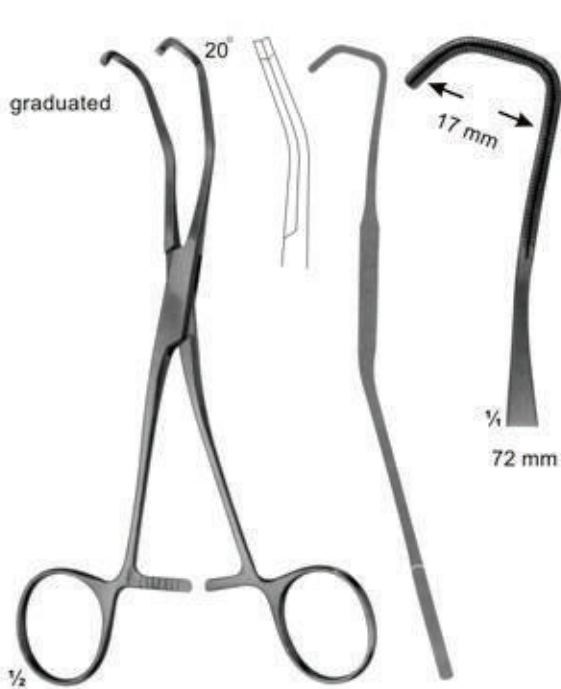

05-7253  
COOLEY  
170 mm

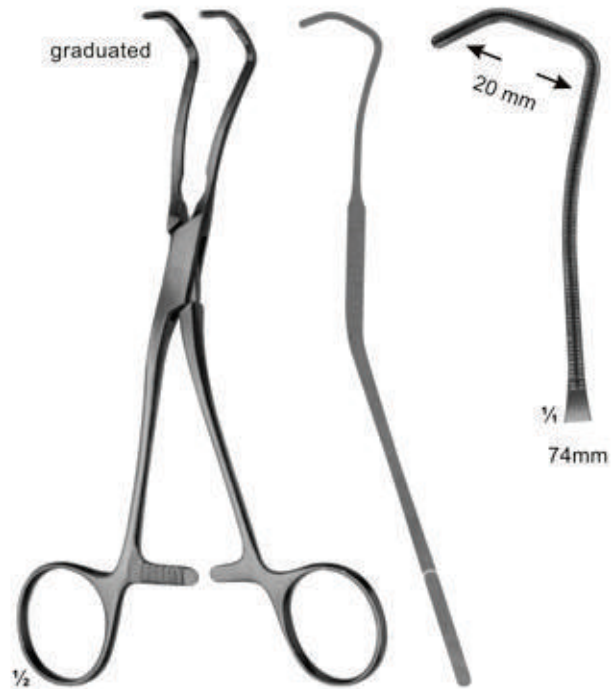

05-7254  
COOLEY  
175 mm



# Multi-Purpose Clamps, Pediatric Types

# Splenor Surgicals

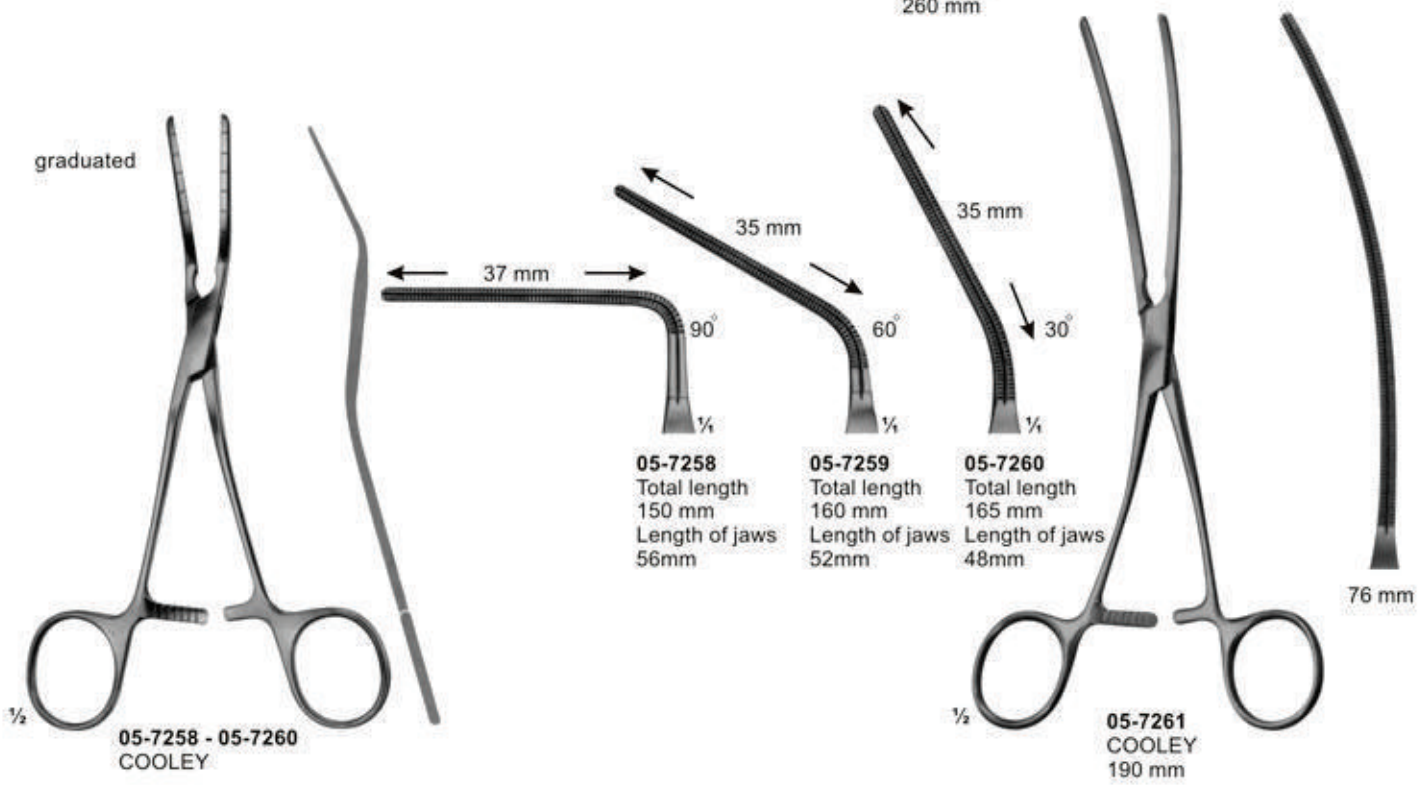
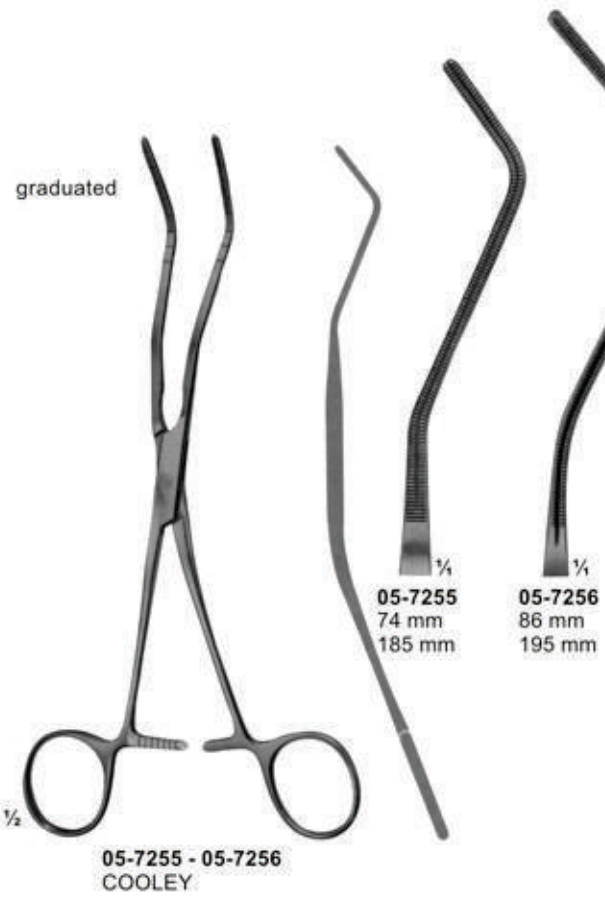



**Atraumata Aorta Clamps, Patent-Ductus  
Clamps, Coarctation Clamps Pediatric Types**

*Splenor Surgicals*

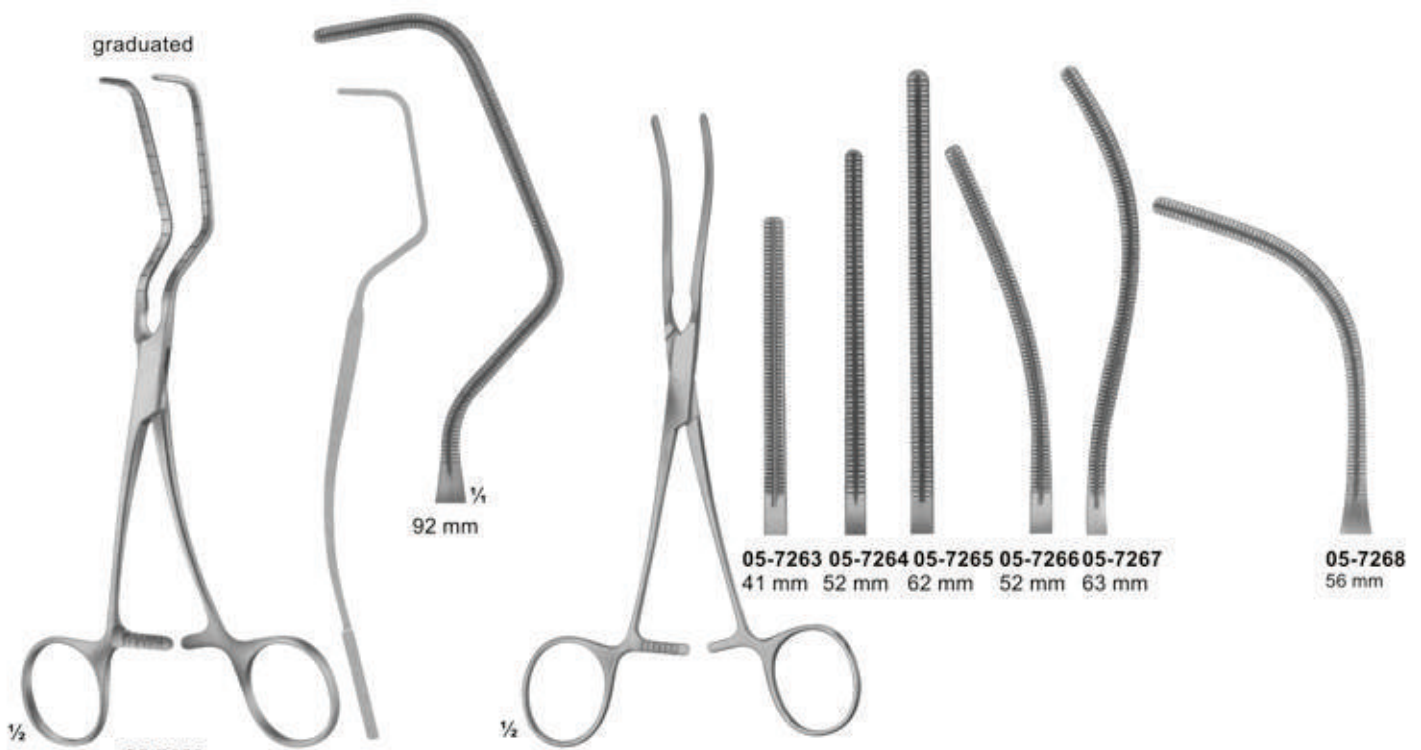

- 05-7263 - 05-7268**  
COOLEY
- 05-7263 160mm
  - 05-7264 170mm
  - 05-7265 180mm
  - 05-7266 180mm
  - 05-7267 180mm
  - 05-7268 160mm

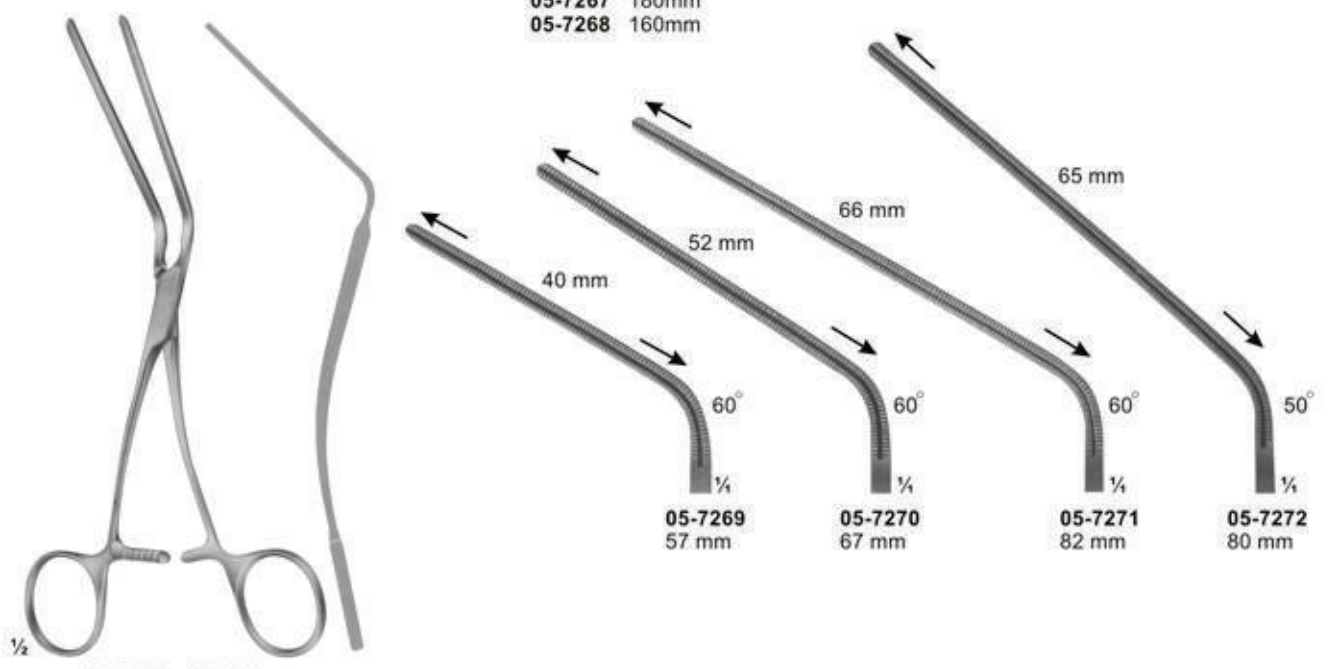

- 05-7269 - 05-7272**
- 05-7269 165mm
  - 05-7270 170mm
  - 05-7271 185mm
  - 05-7272 185mm

# Multi-Purpose Clamps



05-7273 - 05-7282

DARDIK

05-7273	150 mm	05-7278	170 mm
05-7274	150 mm	05-7279	170 mm
05-7275	150 mm	05-7280	170 mm
05-7276	145 mm	05-7281	160 mm
05-7277	130 mm	05-7282	135 mm



Length of jaws	05-7273 38mm	05-7274 38mm	05-7275 38mm	05-7276 38mm	05-7277 38mm
----------------	-----------------	-----------------	-----------------	-----------------	-----------------

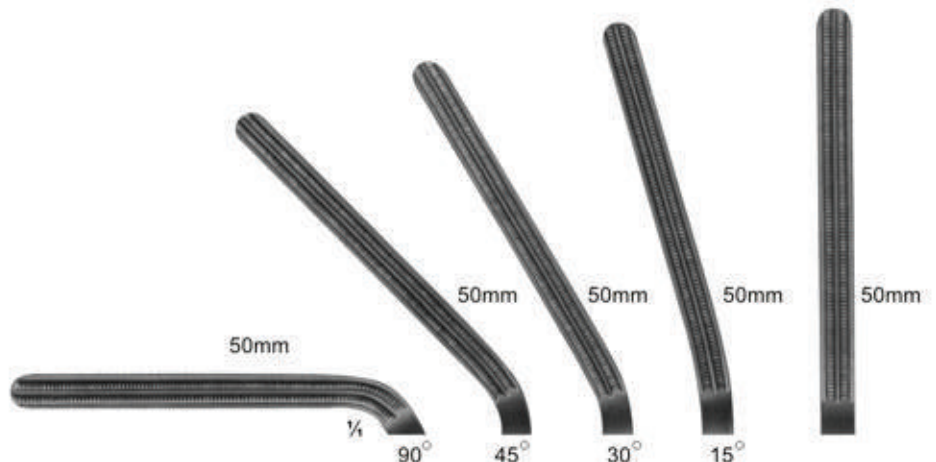

Length of jaws	05-7278 58mm	05-7279 58mm	05-7280 58mm	05-7281 58mm	05-7282 58mm
----------------	-----------------	-----------------	-----------------	-----------------	-----------------



# Lung Grasping Forceps

*Splenor Surgicals*



05-7283  
WILLIAMS  
160 mm



05-7284  
TUTTLE  
230 mm



05-7285  
NELSON  
230 mm



05-7286  
DUVAL  
230 mm



05-7287 - 05-7289  
BABCOCK  
05-7287 170 mm  
05-7288 215 mm  
05-7289 220 mm



05-7290  
ALLIS  
220 mm



05-7291  
FINOCHIETTO  
245 mm



05-7292



05-7293

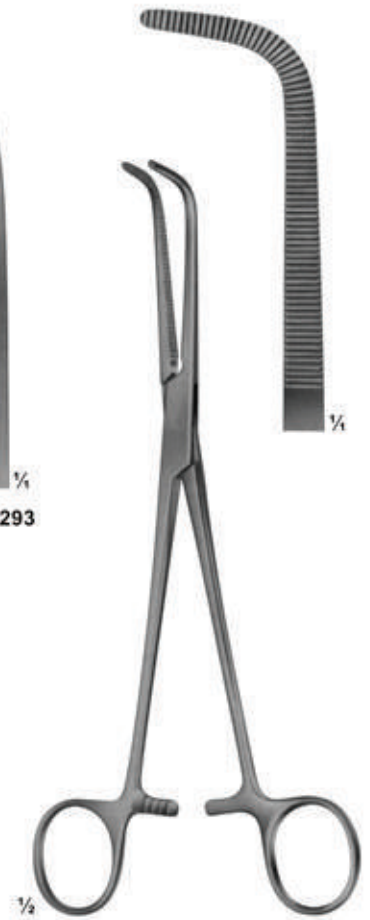

05-7294  
WIKSTROEM  
205 mm

Dissecting And Ligature Forceps,  
Vessel Clamps



05-7295  
MIXTER  
230 mm



05-7296 220 mm  
05-7297 250 mm

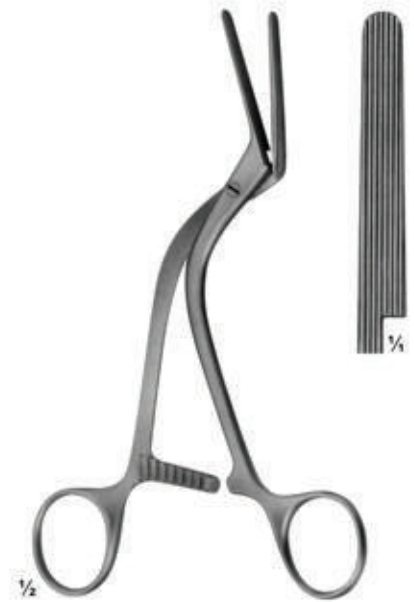

05-7298  
HOEPFNER  
Vessel clamp  
160 mm



**05-7299**  
SATINSKY  
Anastomosis clamps  
265 mm

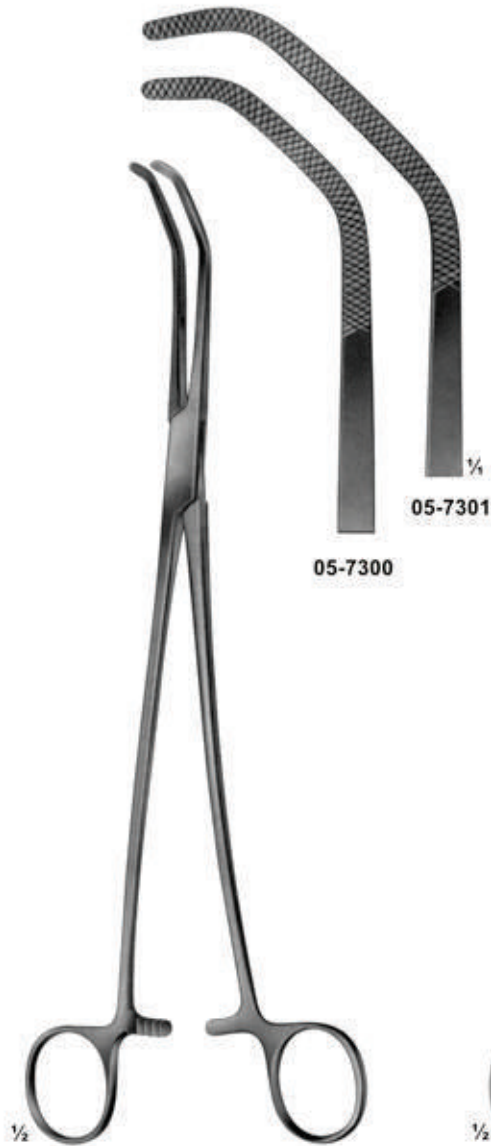

**05-7300 - 05-7301**  
SATINSKY  
Anastomosis clamps  
265 mm



**05-7302**  
HARKEN  
240 mm





# Carotid Clamps, Auricle Clamps

*Splenor Surgicals*



**05-7303**  
PERTUISET  
Carotid Clamp  
90 mm

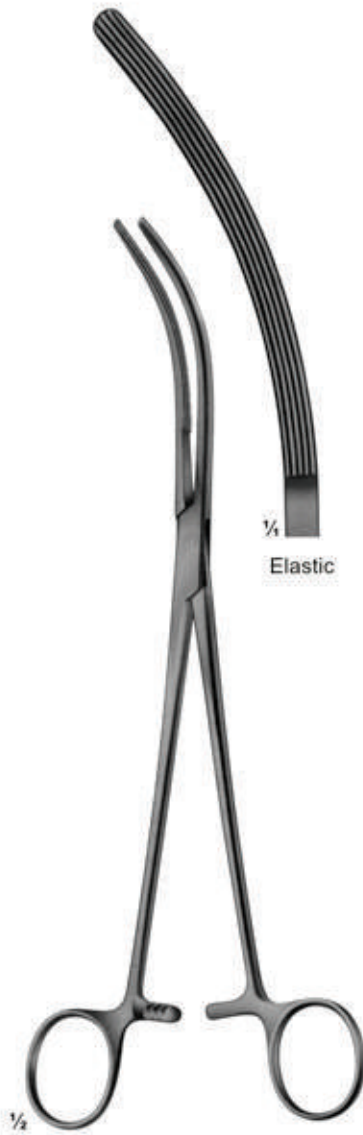

**05-7304**  
CRAFOORD-SELLORS  
240 mm

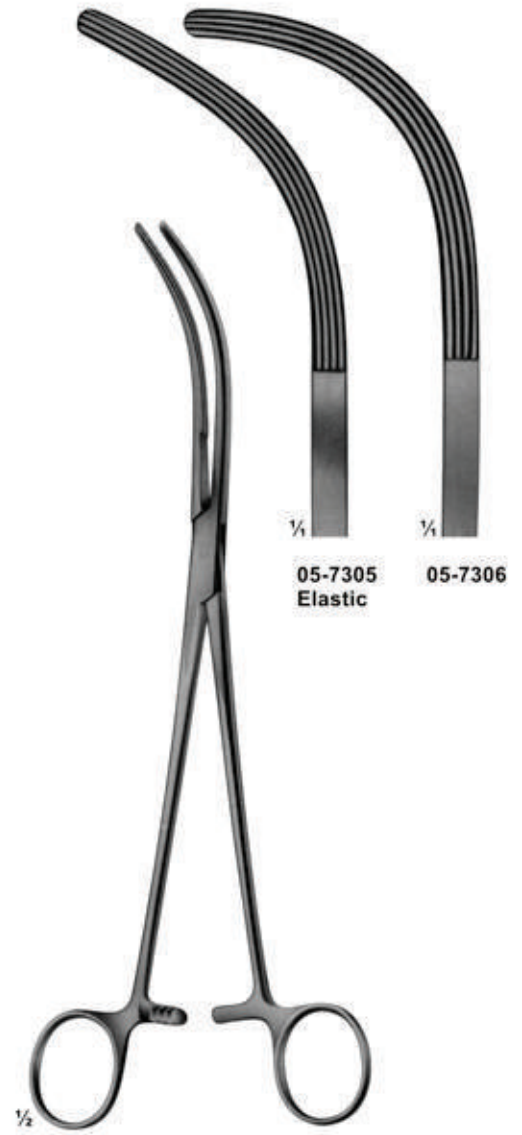

**05-7305 - 05-7306**  
CRAFOORD  
240 mm

# Bronchus Forceps



**05-7307**  
PRICE THOMAS  
225 mm



**05-7308 - 05-7309**  
PRICE THOMAS  
225 mm



**05-7308**  
jaws with pins

**05-7309**  
jaws with pins



# Sternum Instruments And Rib Shears

*Splenor Surgicals*



**05-7310**  
SCHUMACHER  
Sternum shears  
210 mm



**05-7311**  
LEBSCHÉ  
Sternum chisel  
200 mm



**05-7312**  
230 mm



**05-7313**  
COLLIN  
195 mm



**05-7314**  
GLUCK  
190 mm



**05-7315**  
BETHUNE  
340 mm



**05-7316**  
BRUNNER  
Universal Pattern  
340 mm



**05-7317**  
GIERTZ-STILLÉ  
250 mm



# Rib Holding Forceps, Bone Cutting Forceps, Rib Rongeurs

*Splenor Surgicals*



05-7318  
SEM B  
Rib-and Bone  
Holding forceps  
190 mm



05-7319  
SEM B  
Rib-and Bone  
Holding forceps  
190 mm



05-7320  
LISTON-STILLE  
265 mm

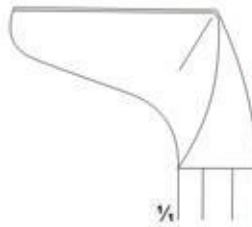

05-7321  
LISTON-KEY-HORSLEY  
(Tudor Edwards)  
255 mm



S-shaped for posterior  
rib ends.



05-7323



05-7324



05-7322  
SEM B  
Rib Rongeur to shorten  
the rib stumps  
240 mm



05-7323 - 05-7324  
SAUERBRUCH-CORYLLOS  
Rib rongeurs to shorten  
the rib stumps  
310 mm



05-7325  
MARKWALDER  
Rib Rongeur to Round  
the rib stumps  
190 mm

# Rib Raspatories



05-7326 - 05-7327  
DOYEN  
for children  
175 mm



05-7328 - 05-7329  
DOYEN  
for adults  
175 mm



05-7330 - 05-7331  
DOYEN  
240 mm



# Rib Raspatories

*Splenor Surgicals*



1/2  
**05-7332 - 05-7336**  
SEMB  
230 mm



12 mm  
1/4  
**05-7332**  
190 mm



12 mm  
1/4  
**05-7333**  
230mm



13 mm  
1/4  
**05-7334**  
230mm



13 mm  
1/4  
**05-7335**  
230mm



15 mm  
1/4  
**05-7336**  
230mm



1/2  
**05-7337**  
LANGENBECK  
190 mm



1/2  
**05-7338 - 05-7342**  
LAMBOTTE  
215 mm

- 05-7338** 5 mm
- 05-7339** 10 mm
- 05-7340** 15 mm
- 05-7341** 20 mm
- 05-7342** 25 mm

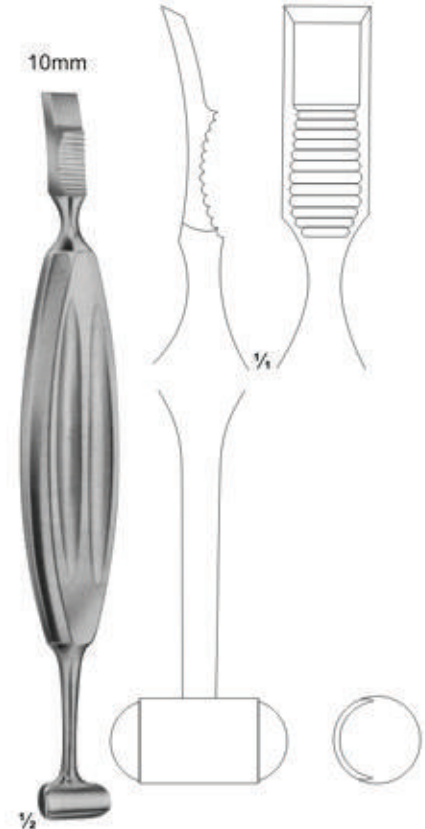

10mm  
1/4  
**05-7343**  
ALEXANDER  
210 mm



# Rib Spreaders

*Splenor Surgicals*

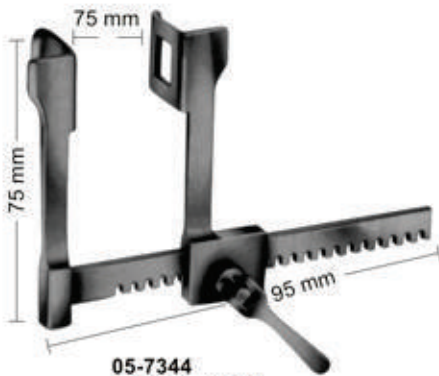

**05-7344**  
FINOCHIETTO  
Blades  
18X21 mm



**05-7345**  
HERTZLER  
Blades  
20X25 mm

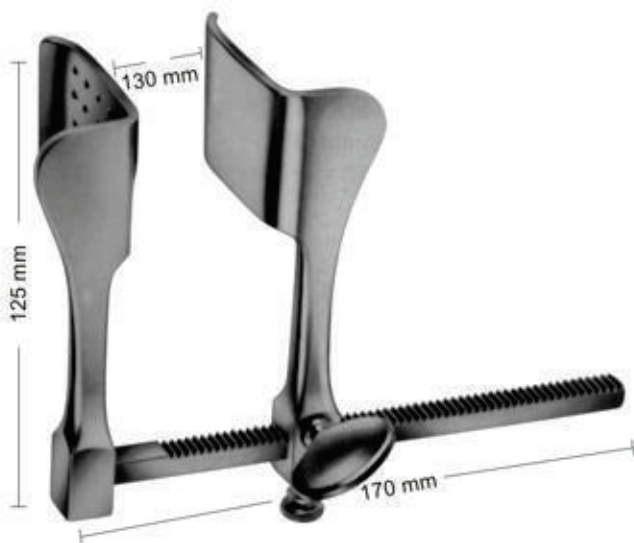

**05-7346**  
TUFFIER  
Blades  
43X53 mm

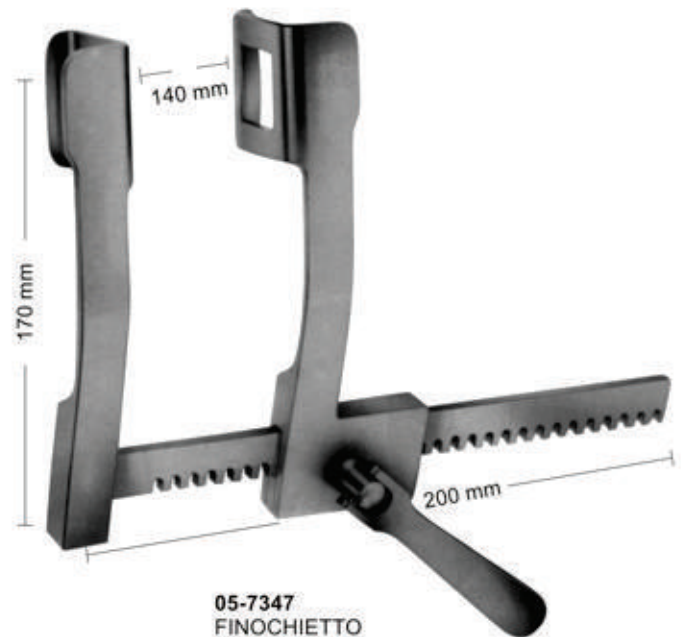

**05-7347**  
FINOCHIETTO  
Blades  
36X45 mm



# Rib Spreaders

*Splenor Surgicals*

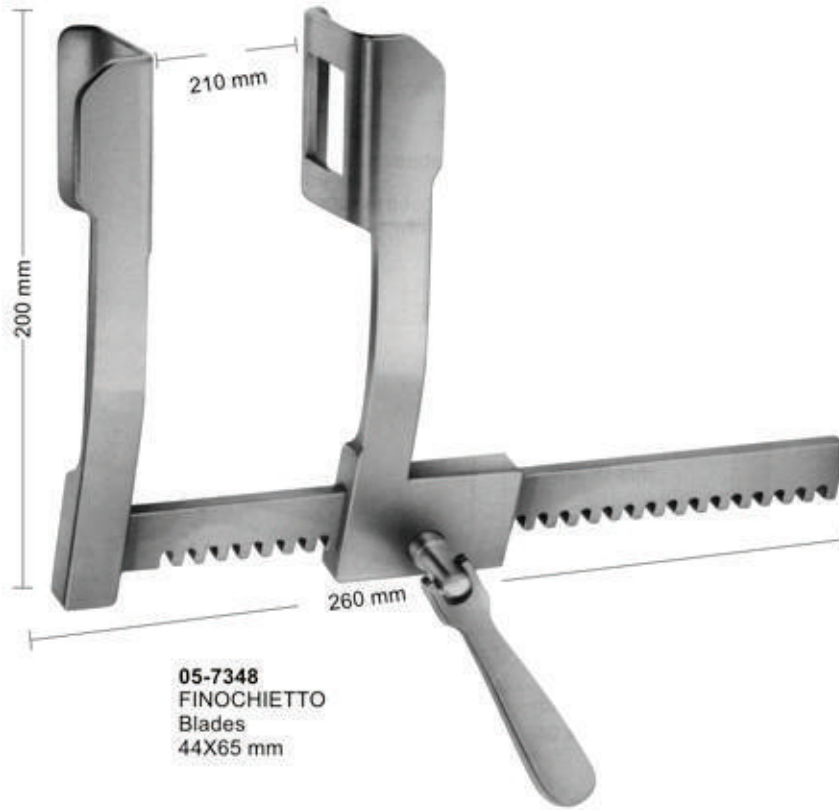

**05-7348**  
FINOCHIETTO  
Blades  
44X65 mm

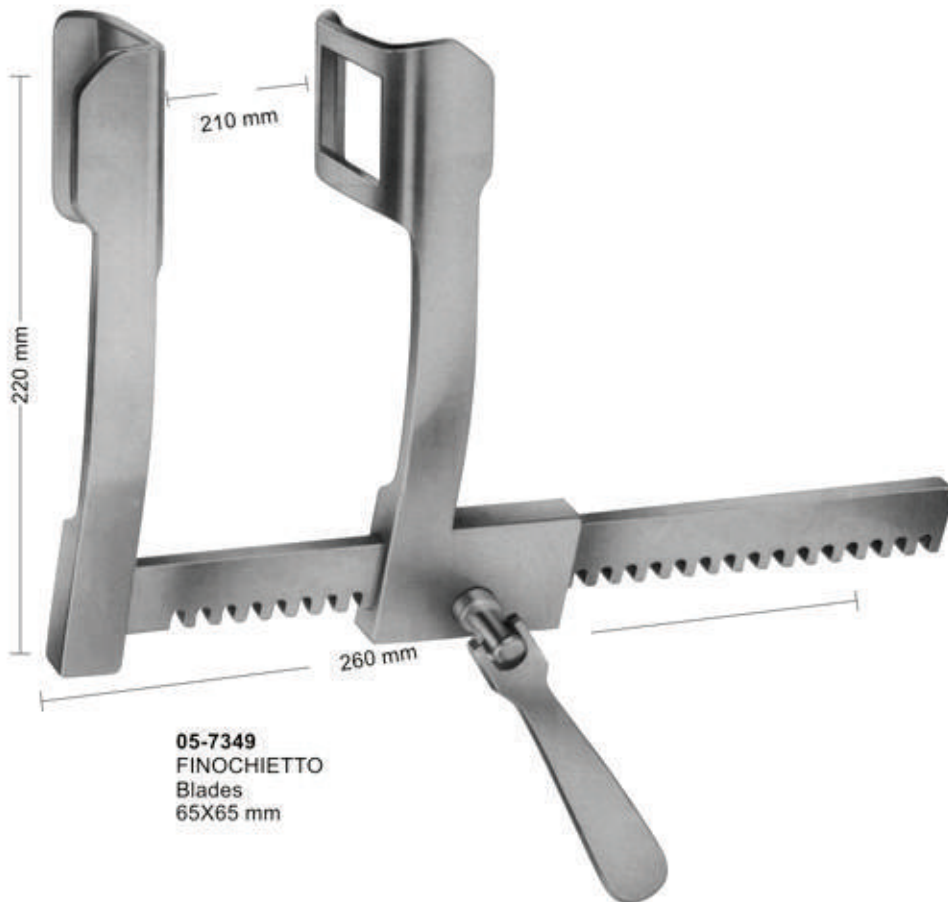

**05-7349**  
FINOCHIETTO  
Blades  
65X65 mm



**05-7351**  
Blades  
30x80 mm



**05-7352**  
Blades  
40x67 mm



**05-7353**  
Blades  
80x67 mm



220 mm

220 mm

**05-7354**  
Blade, Only, for preparation  
of a. Mammaria, 25.5x80mm

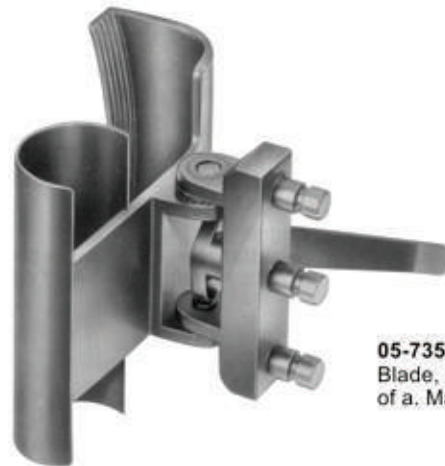

300 mm

**05-7350**  
FINOCHIETTO-BURFORD  
with 2 pairs of blades  
(05-7352 - 05-7353)

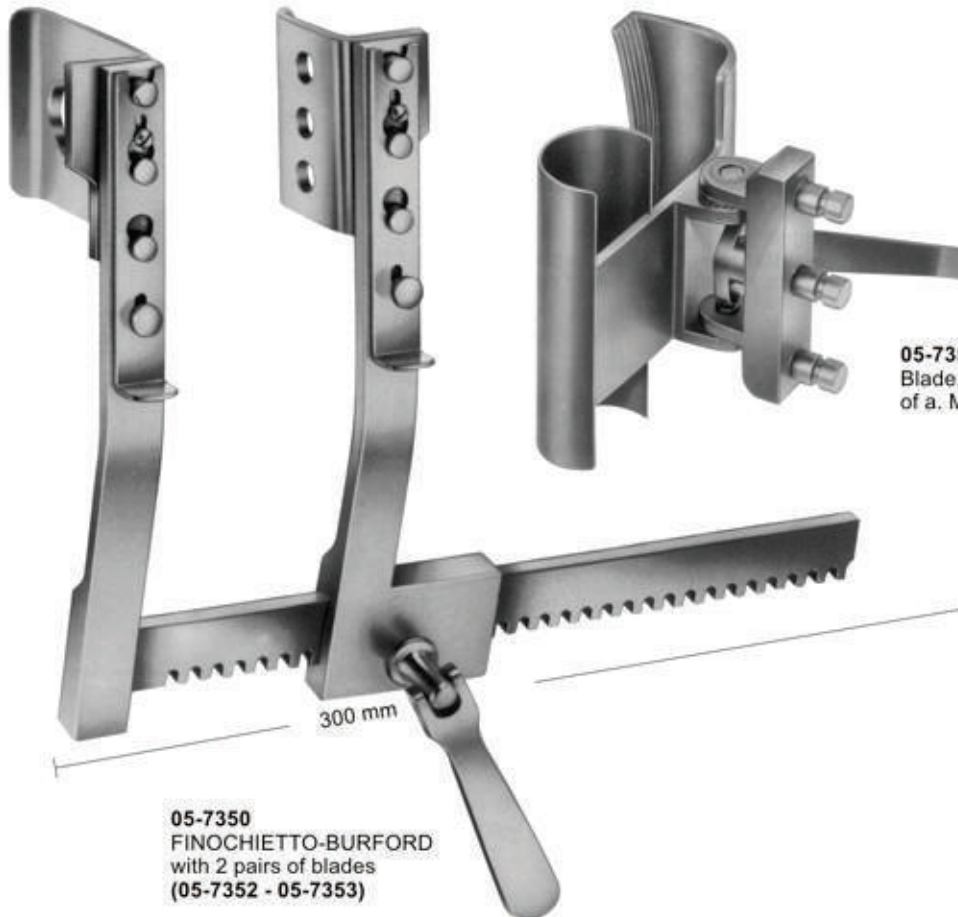



# Rib Spreaders

*Splenor Surgicals*

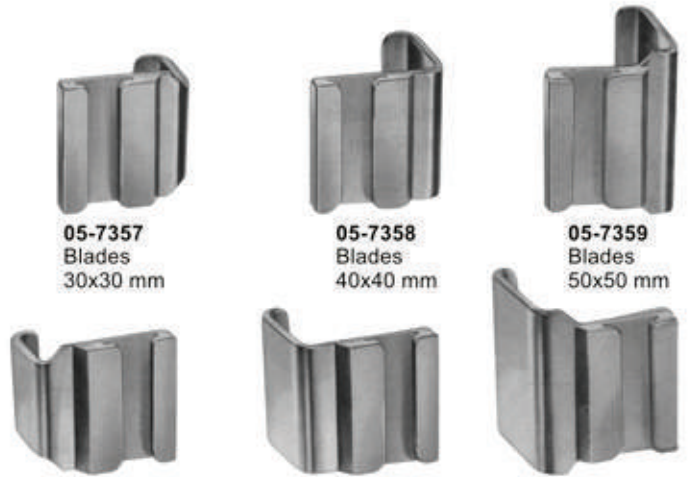
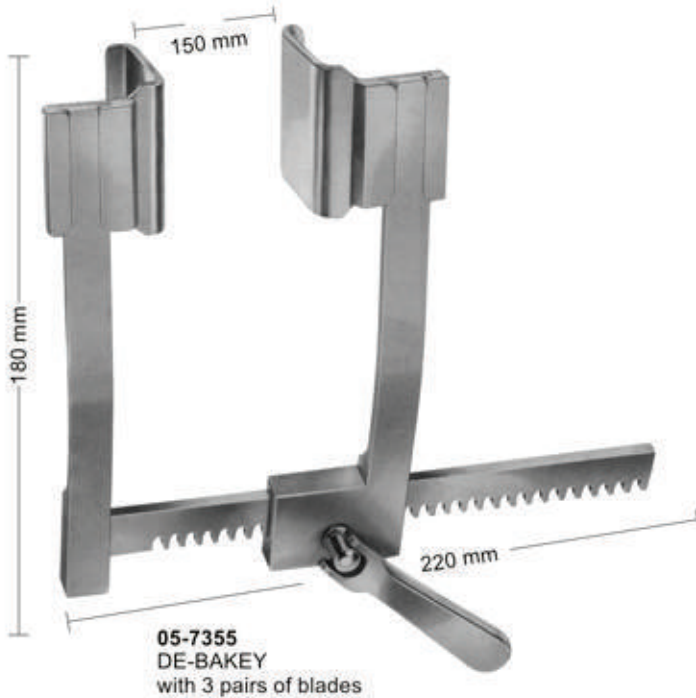

Components for **05-7355**  
 Spreader only      Blades only  
**05-7356**      **05-7357** 30x30mm  
                   **05-7358** 40x40mm  
                   **05-7359** 50x50mm  
 The Blades are delivered in Pairs.

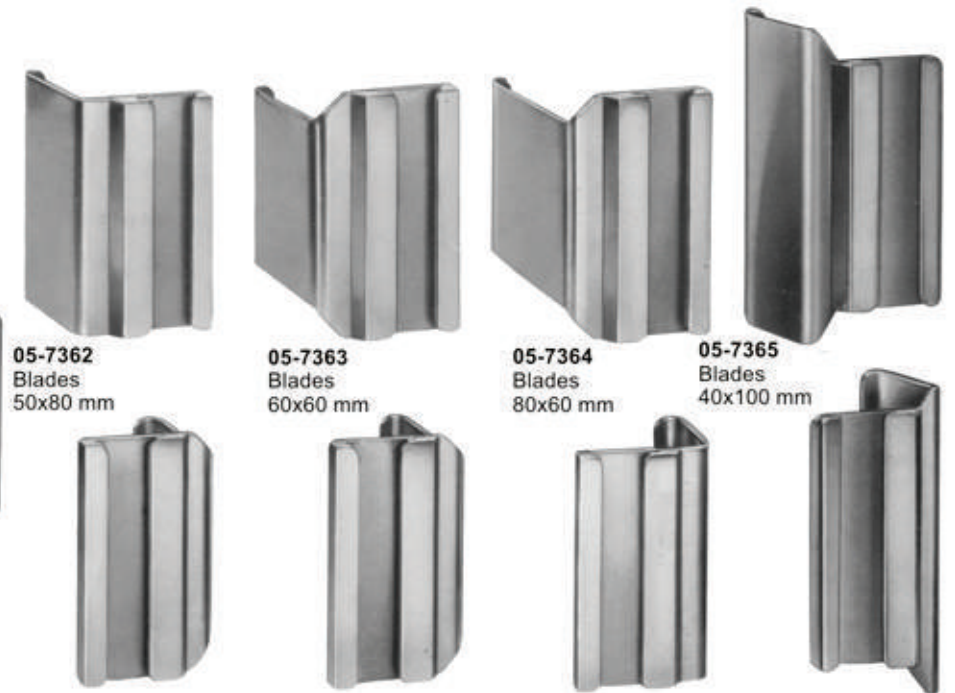
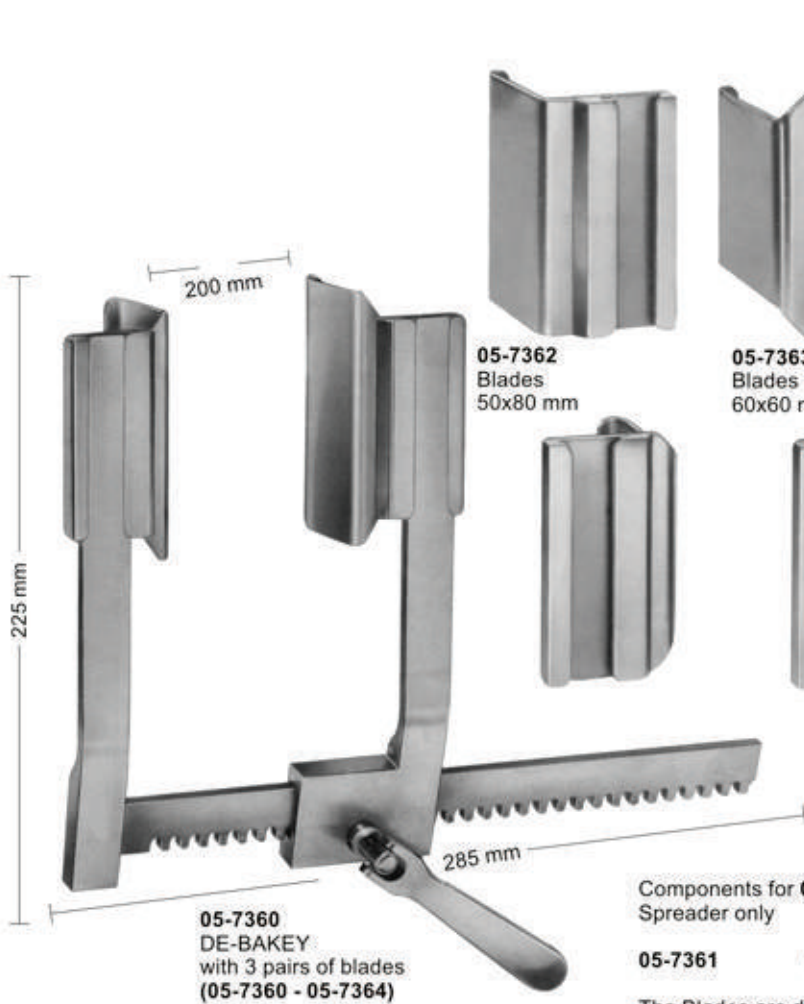

Components for **05-7360**  
 Spreader only      Blades only  
**05-7361**      **05-7362** 50x80mm  
                   **05-7363** 60x60mm  
                   **05-7364** 40x100mm  
 The Blades are delivered in Pairs.





## Sternotomy Spreaders

*Splenor Surgicals*

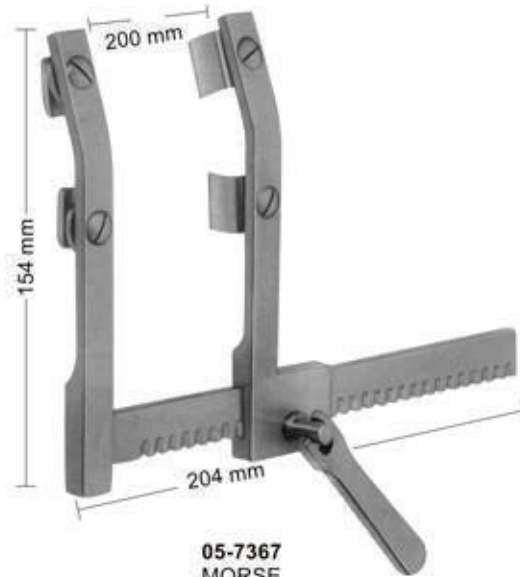

**05-7367**  
**MORSE**  
Sternotomy spreader  
for children, with moveable  
double, blades each blade  
12x20 mm

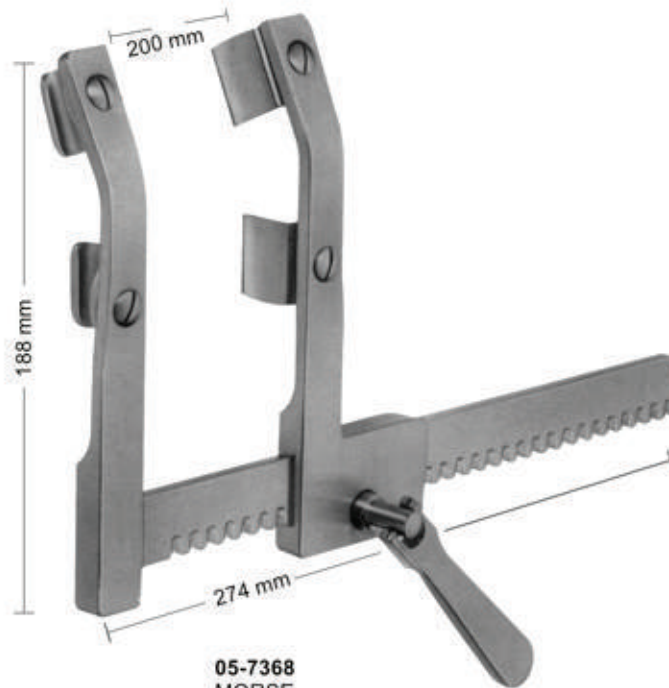

**05-7368**  
**MORSE**  
Sternotomy spreader  
for adults, with moveable  
double, blades each blade  
19x19 mm



# Sternotomy- Spreaders

*Splenor Surgicals*

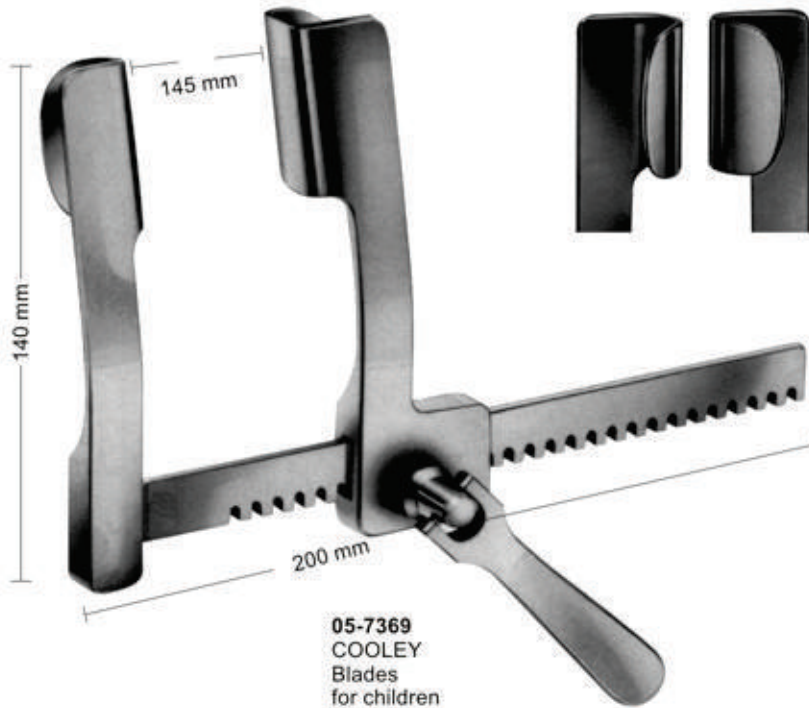

**05-7369**  
COOLEY  
Blades  
for children  
21x45mm

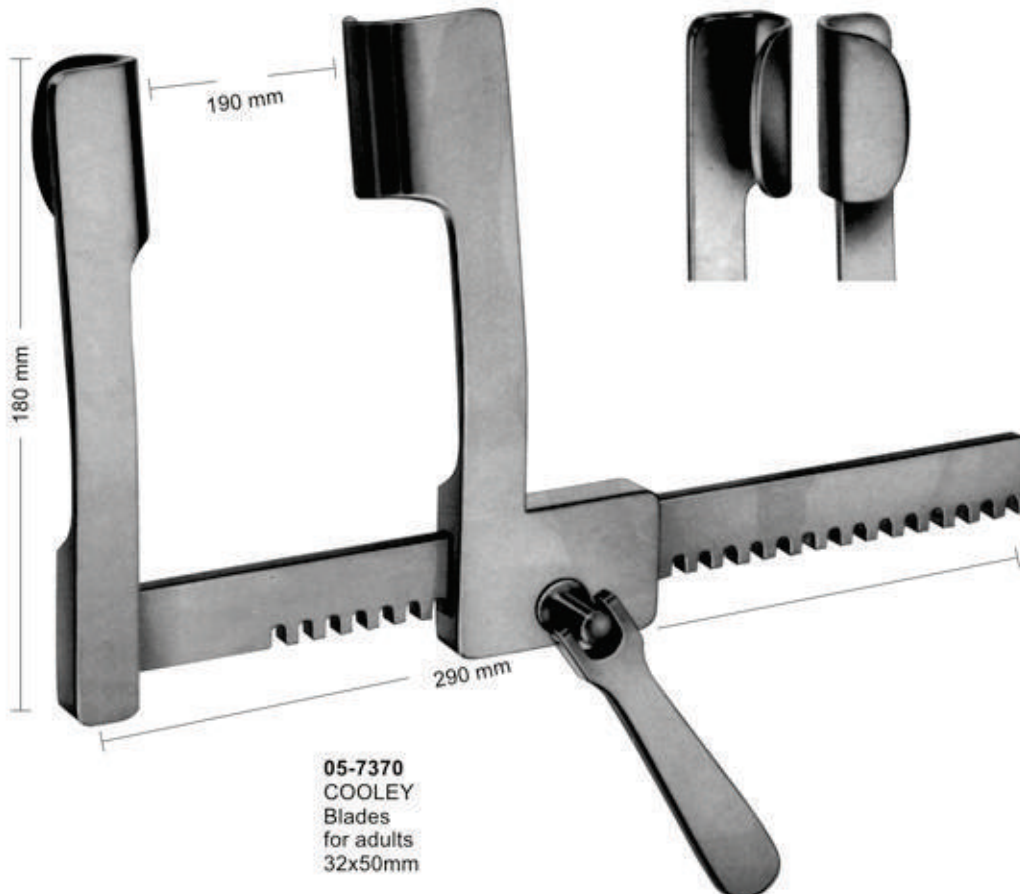

**05-7370**  
COOLEY  
Blades  
for adults  
32x50mm



# Thoracic Retractors

*Splenor Surgicals*



**05-7371**  
Blades  
75x75 mm



**05-7373**  
Blades  
42x65 mm

Blades with Ball Snap System  
Delivery: in Pairs

- 05-7371 - 05-7373**  
Thoracic Retractor (Mercedes-Retractor)  
complete consisting of:  
**05-7371** Retractor only  
**05-7372** 1 Pair of blades 75x75 mm  
**05-7373** 1 Pair of blades 42x65 mm



**05-7374**  
**SELLORS**  
 Rib spreader-and contractor  
 with swivel blades  
 200 mm



**05-7375**  
**BAILEY**  
 150 mm



**05-7376**  
 for children

**05-7377**  
 for adults

**05-7376 - 05-7377**  
**BAILEY**  
 200 mm



# Retractors, Lung Spatulas

*Splenor Surgicals*

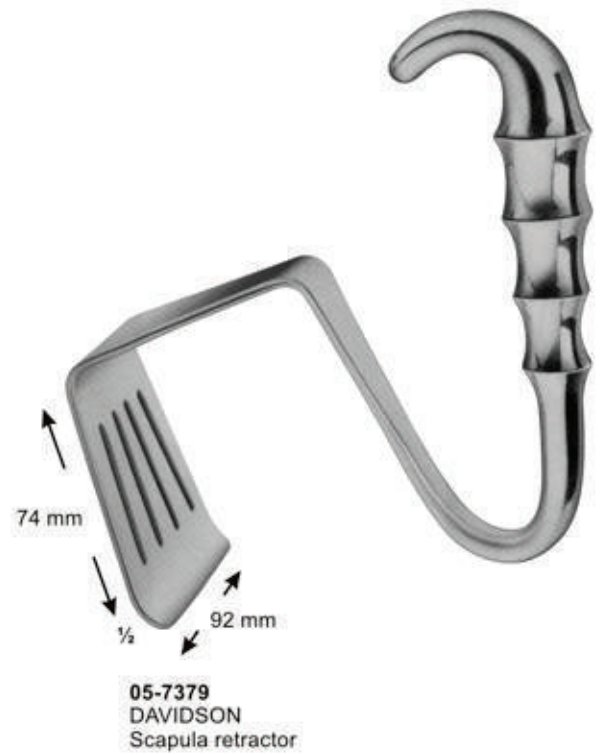
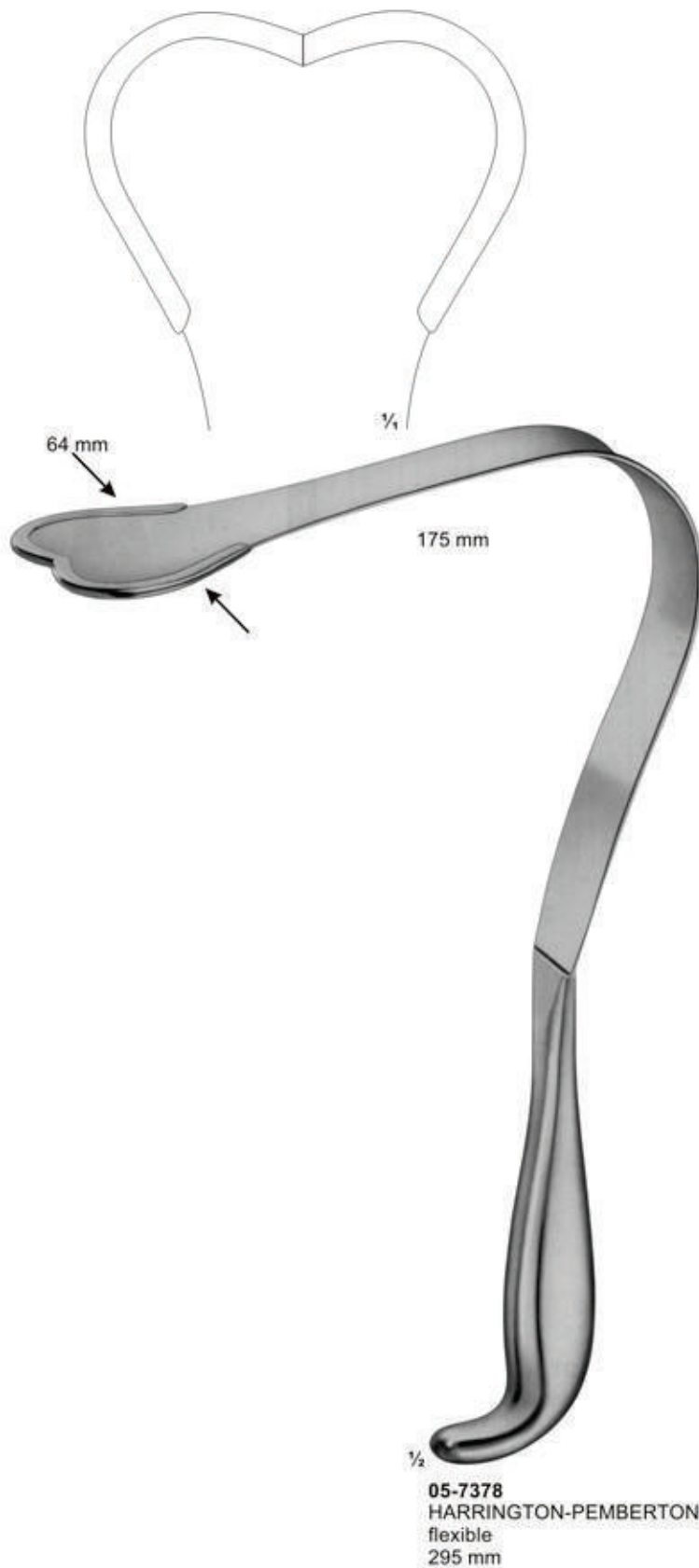



# Lung Spatulas, Suction Cannulae

*Splenor Surgicals*



**05-7380**  
ALLISON  
255 mm



**05-7381**  
ALLISON  
320 mm



**05-7382**  
DE BAKEY  
With central bore,  
3.0mm diam.  
with lateral slots  
275 mm



**05-7383**  
YANKAUER  
With central bore,  
2.0mm diam.  
285 mm





# Uterine Dilators



1/2

04-6139	1	mm	04-6161	23	mm
04-6140	2	mm	04-6162	24	mm
04-6141	3	mm	04-6163	25	mm
04-6142	4	mm	04-6164	26	mm
04-6143	5	mm	04-6165	1	1/2mm
04-6144	6	mm	04-6166	2	1/2mm
04-6145	7	mm	04-6167	3	1/2mm
04-6146	8	mm	04-6168	4	1/2mm
04-6147	9	mm	04-6169	5	1/2mm
04-6148	10	mm	04-6170	6	1/2mm
04-6149	11	mm	04-6171	7	1/2mm
04-6150	12	mm	04-6172	8	1/2mm
04-6151	13	mm	04-6173	9	1/2mm
04-6152	14	mm	04-6174	10	1/2mm
04-6153	15	mm	04-6175	11	1/2mm
04-6154	16	mm	04-6176	12	1/2mm
04-6155	17	mm	04-6177	13	1/2mm
04-6156	18	mm	04-6178	14	1/2mm
04-6157	19	mm	04-6179	15	1/2mm
04-6158	20	mm	04-6180	16	1/2mm
04-6159	21	mm	04-6181	17	1/2mm
04-6160	22	mm			

04-6139 - 04-6181  
HEGAR  
with very conical point  
185 mm



1/2

04-6182	1+2	mm
04-6183	3+4	mm
04-6184	5+6	mm
04-6185	7+8	mm
04-6186	9+10	mm
04-6187	11+12	mm
04-6188	13+14	mm
04-6189	15+16	mm
04-6190	17+18	mm

04-6182 - 04-6190  
HEGAR  
205 mm



1/4

04-6191  
HEGAR  
Uterine dilator set, in canvas roll  
with 8 dilators.



## Uterine Dilators - Complete Sets

*Splenor Surgicals*



**04-6192**  
HEGAR  
Dilator set consisting of:  
14 Dilators,  
(04-6193) 1 Rack for dilators ( 4 - 12 mm )  
(04-6194) 1 Rack for Dilators ( 13 - 17 mm )  
(04-6195) 1 Metal case only,  
with hinged lid, stainless 200 X 100 X 35 mm



**04-6196**  
HEGAR  
Dilator set consisting of:  
26 Dilators,  
(04-6197) 1 Rack for dilators ( 1 - 17 mm )  
(04-6198) 1 Rack for Dilators ( 18 - 26 mm )  
(04-6199) 1 Metal case only,  
with hinged lid, of aluminium 330 X 220 X 80 mm



**04-6200**  
KOGAN  
Endospecula for cervix  
and urethra, without ratchet  
240 mm



**04-6201**  
KOGAN  
Endospecula for cervix  
and urethra, with  
scale-ratchet and fixing screws  
240 mm



# Uterine Probes



**04-6202**  
MAYO  
malleable  
330 mm



**04-6203**  
SIMS  
malleable  
330 mm  
**04-6204**  
SIMS  
330mm



**04-6205**  
MARTIN  
330 mm



**04-6206**  
SIMPSON  
malleable  
silver-plated  
290 mm



**04-6207**  
BRAUN  
Uterine  
depressor  
270 mm



**04-6208**  
Cotton  
applicator  
270 mm



# Uterine Dressing Forceps

*Splenor Surgicals*



Jaws with longitudinal groove



# Uterine Dressing Forceps

*Splenor Surgicals*



Standard



04-6216  
BRAUN  
slender type  
250 mm



04-6217  
SCHROEDER  
250 mm



04-6218  
POZZI  
heavy type  
255 mm



# Uterine Tenaculum Forceps

Splenor Surgicals



04-6219  
MARTIN  
265 mm



04-6220  
DUPLAY  
250 mm

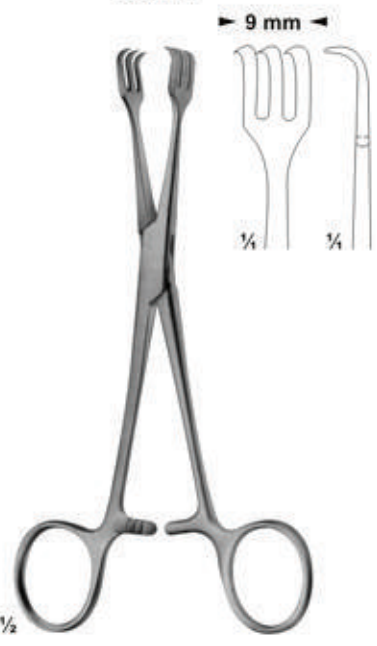

04-6221  
LAHEY  
155 mm



04-6222 - 04-6224  
SCHROEDER  
250 mm





# Uterine Tenaculum Forceps

*Splenor Surgicals*

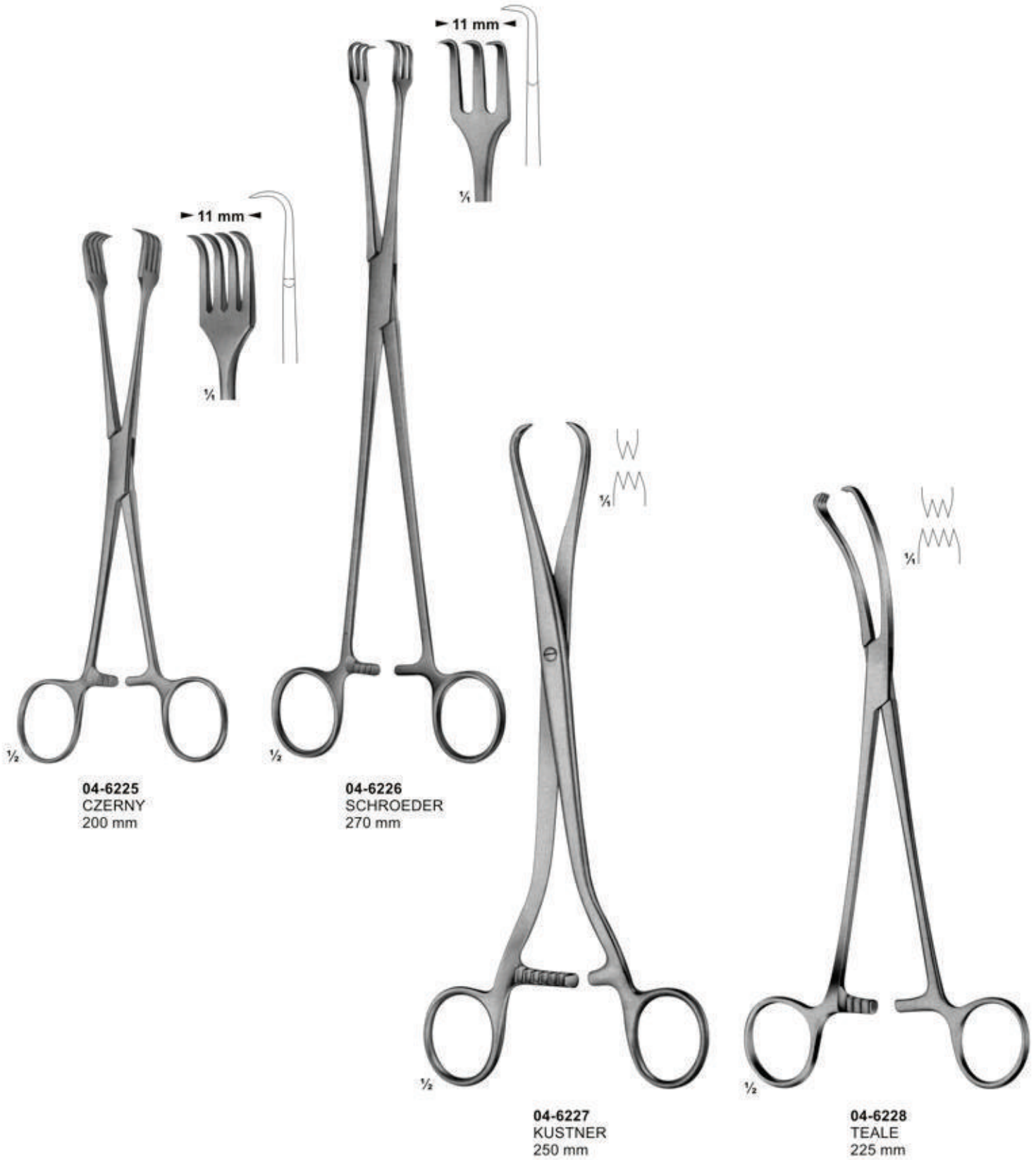

1/2

**04-6225**  
CZERNY  
200 mm

1/2

**04-6226**  
SCHROEDER  
270 mm

1/2

**04-6227**  
KUSTNER  
250 mm

1/2

**04-6228**  
TEALE  
225 mm



# Uterine Tenaculum Forceps

*Splenor Surgicals*

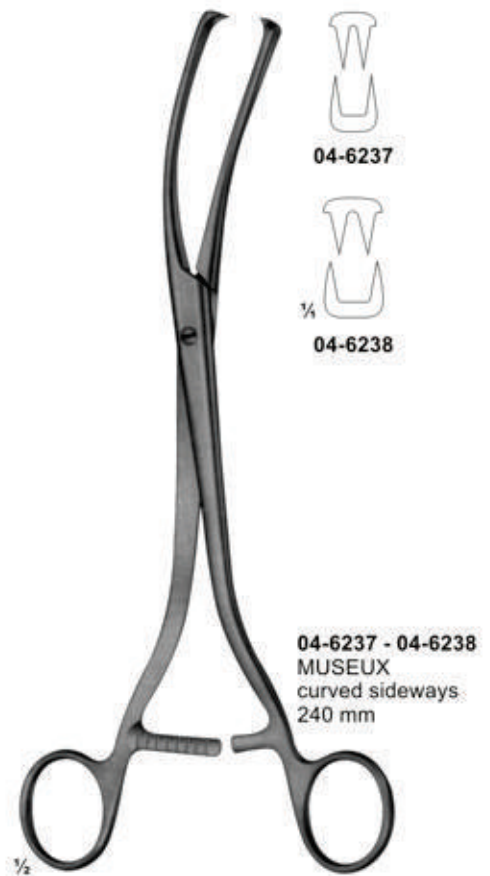
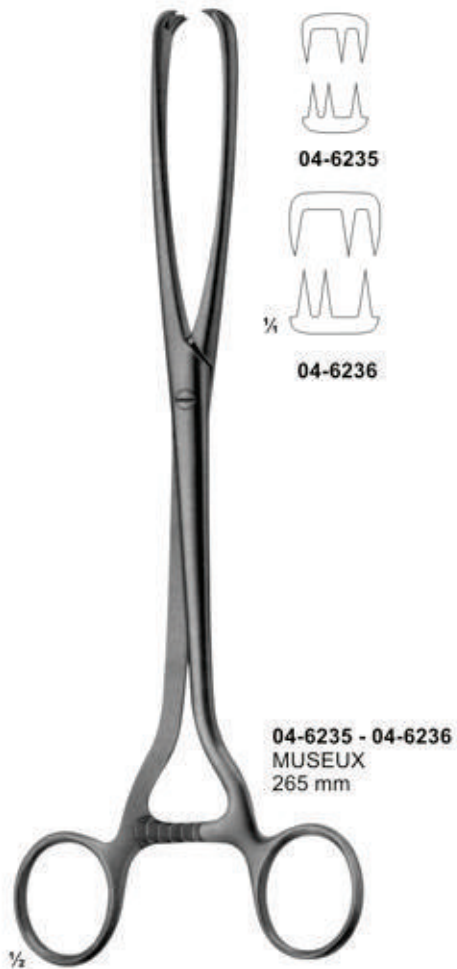



**04-6239**  
HEYWOOD-SMITH  
200 mm

**04-6240**  
KELLY  
320 mm

**04-6241**  
HEYWOOD-SMITH  
250 mm

**04-6242**  
NOTO  
280 mm



# Polypus and Ovum Forceps

*Splenor Surgicals*

## Atraumata



¼



¼



¼



¼

**04-6244**  
250mm

**04-6245**  
270mm



½

**04-6243**  
DOYEN  
185 mm



½

**04-6244 - 04-6245**



½

**04-6246**  
BUMM  
280 mm

# Uterine Elevating Forceps



04-6247  
COLLIN  
250 mm



04-6248  
COLLIN  
285 mm



04-6249  
DARTIGUES  
255 mm



04-6250  
SOMER  
235 mm



04-6251  
STRASSMANN  
265 mm



# Uterine Elevating Forceps

*Splenor Surgicals*

With movable jaws



04-6252  
COLLIN  
265 mm

With movable jaws



04-6253  
APPREX  
approx. 260 mm

# Myoma Instruments, Instruments For Micro Tubal Operations



**04-6254**  
SEGOND  
Myomatome  
270 mm



**04-6255**  
DOYEN  
Myoma screw  
150 mm



**04-6256**  
DOYEN  
Myoma screw  
190 mm



**04-6257** **04-6258** **04-6259**  
∅ 6mm ∅ 8mm ∅ 10mm

**04-6257 - 04-6259**  
NEUBUSER  
Tubal seizing forceps  
200 mm

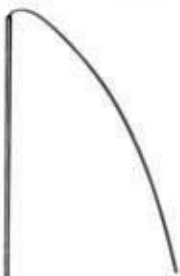

**04-6260**  
Splint guide  
with thread



**04-6261**  
Splint guide with  
round handle  
180 mm



**04-6262**  
Angled glass rods  
Set . 3 pieces

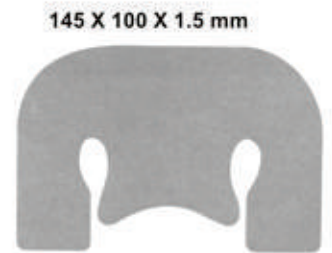

**04-6263**  
Silicon operating pad  
pre-cut



**04-6264**  
Polyaethylen splint material  
soft-sterile  
0.45 mm



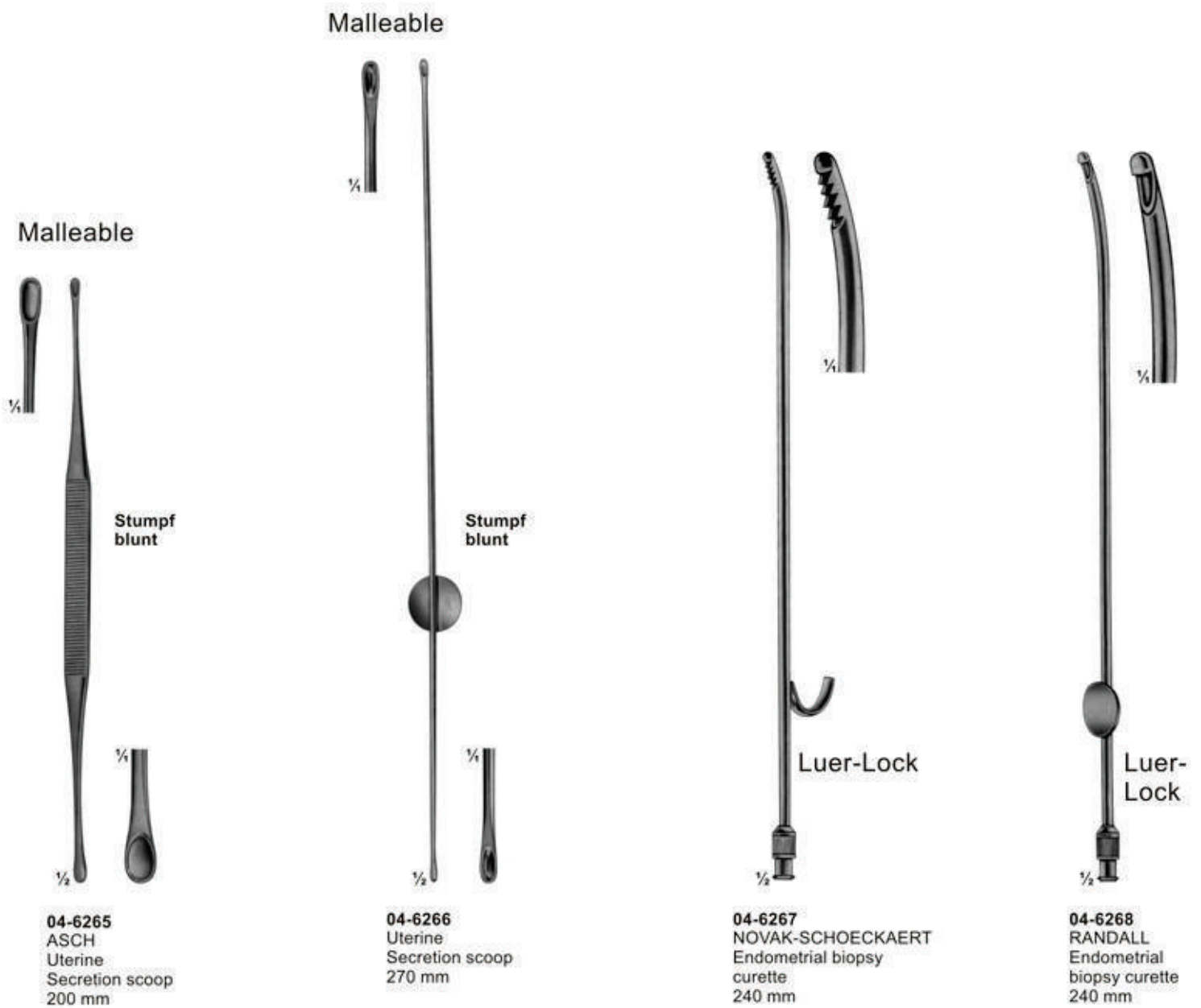



# Biopsy Forceps

*Splenor Surgicals*





# Biopsy Forceps

## Splenor Surgicals

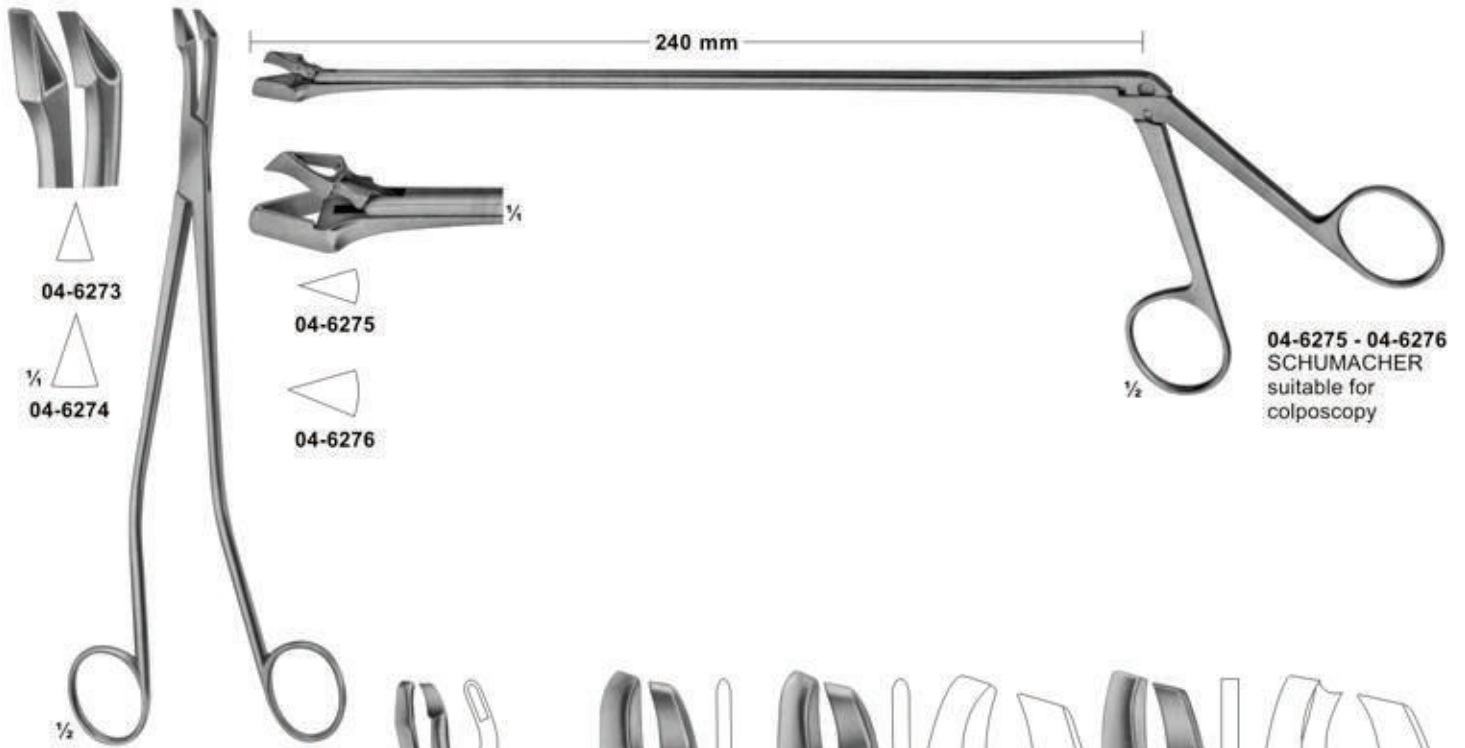

04-6275 - 04-6276  
SCHUMACHER  
suitable for  
colposcopy

04-6273 - 04-6274  
SCHUMACHER  
240mm

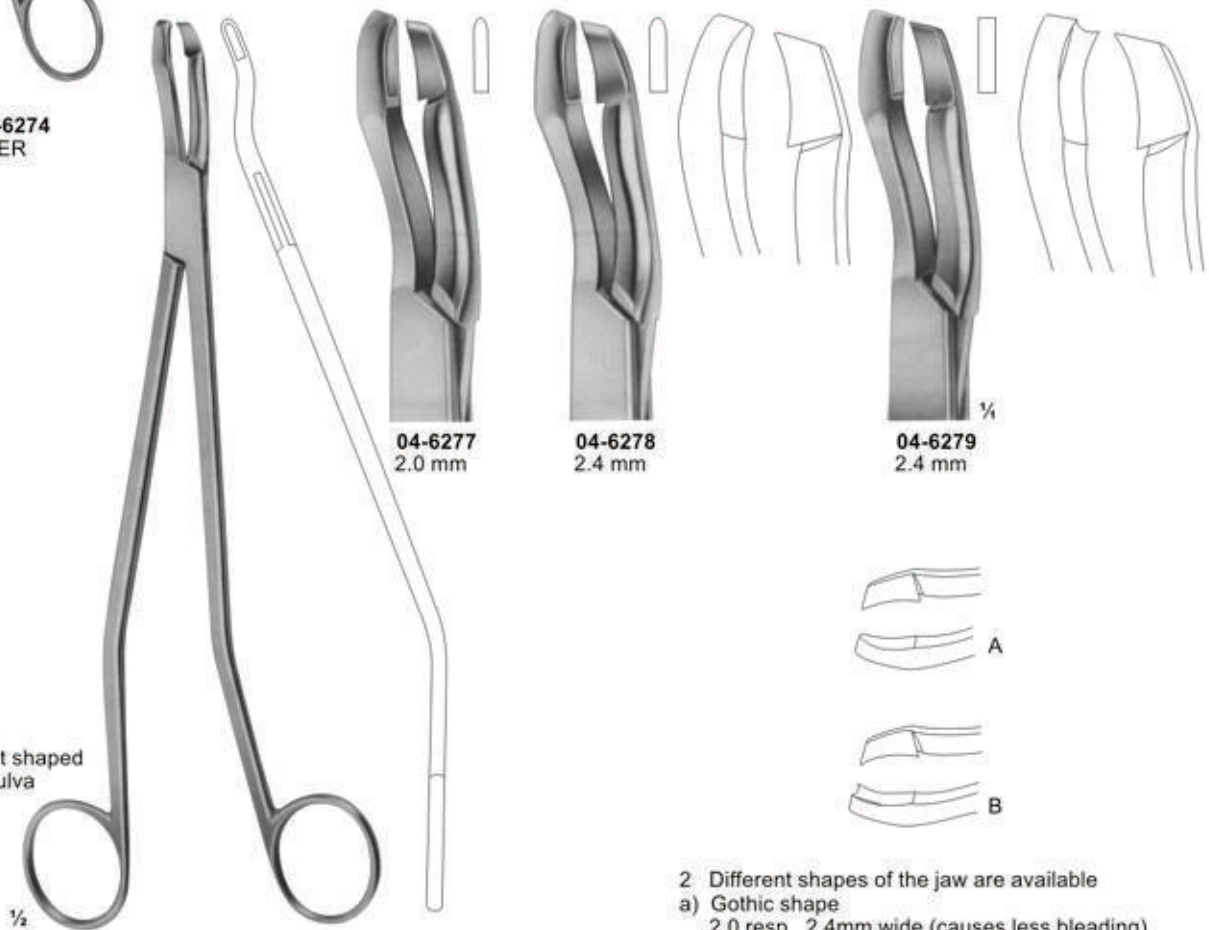

04-6277 - 04-6279  
SEIDL DBP  
Biopsy forceps, bayonet shaped  
for portio, vagina and vulva  
240mm

- 2 Different shapes of the jaw are available
- a) Gothic shape  
2.0 resp 2.4mm wide (causes less bleeding)
- b) Rectangular shape, 2.4mm wide



# Biopsy Forceps

## Splenor Surgicals

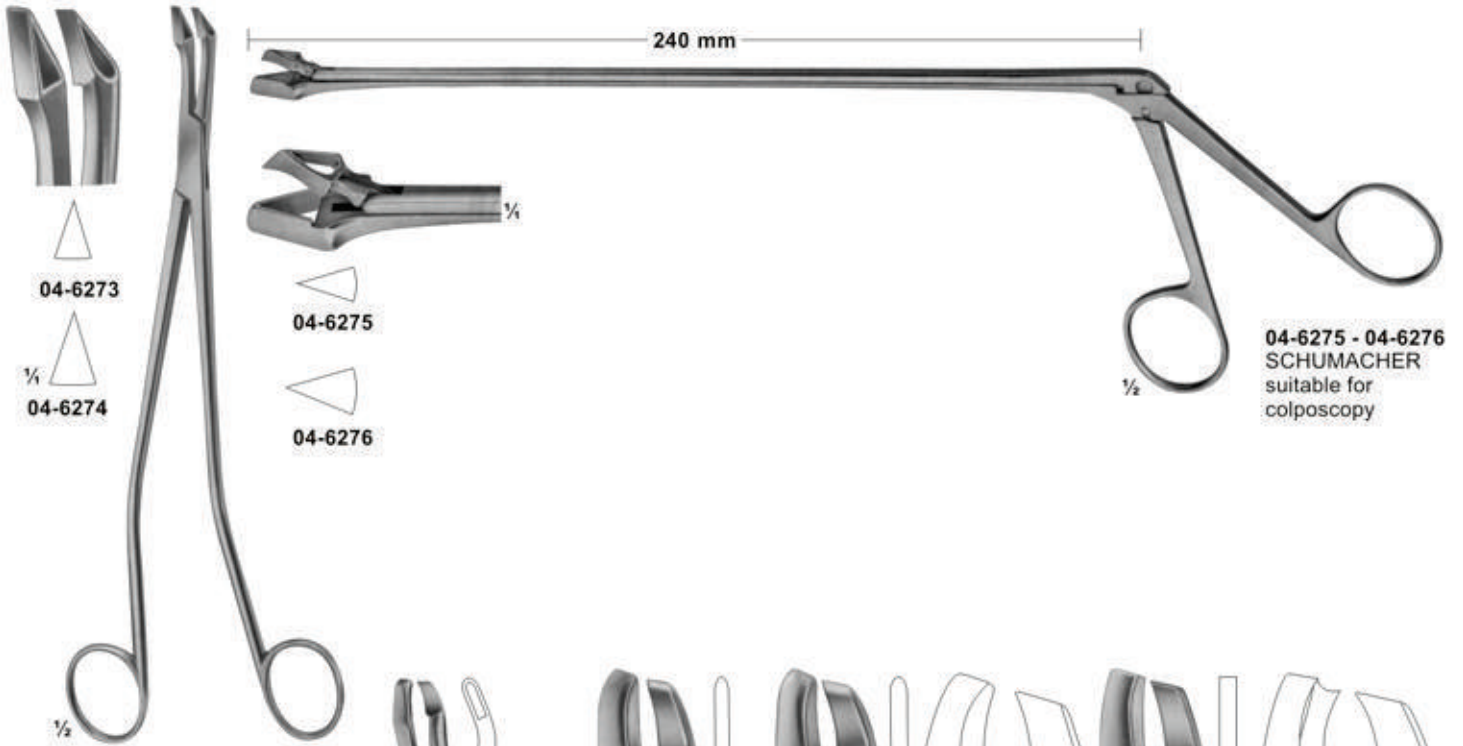

04-6273 - 04-6274  
SCHUMACHER  
240mm

04-6275 - 04-6276  
SCHUMACHER  
suitable for  
colposcopy

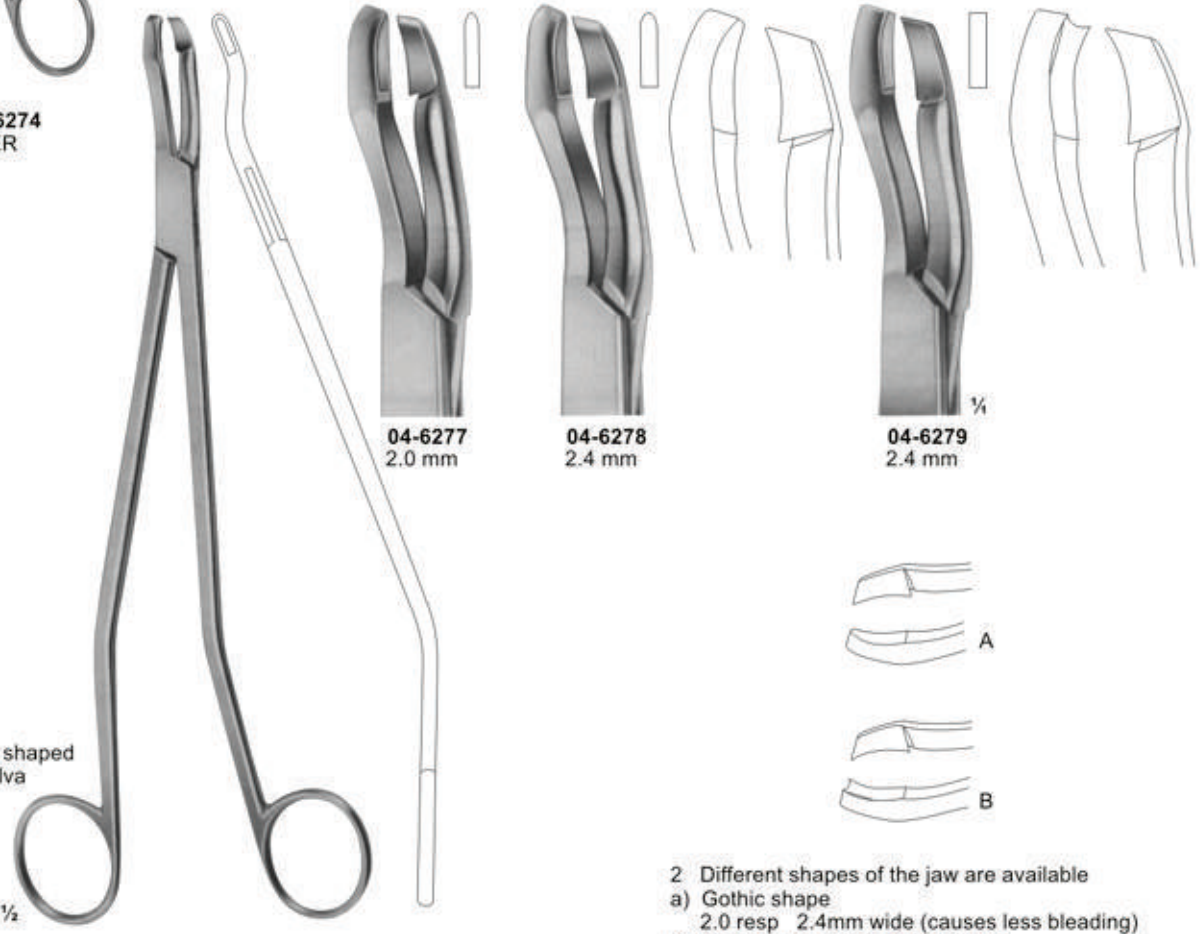

04-6277 - 04-6279  
SEIDL DBP  
Biopsy forceps, bayonet shaped  
for portio, vagina and vulva  
240mm

04-6277  
2.0 mm

04-6278  
2.4 mm

04-6279  
2.4 mm

- 2 Different shapes of the jaw are available
- a) Gothic shape  
2.0 resp 2.4mm wide (causes less bleeding)
- b) Rectangular shape, 2.4mm wide



# Biopsy Forceps

## Splenor Surgicals

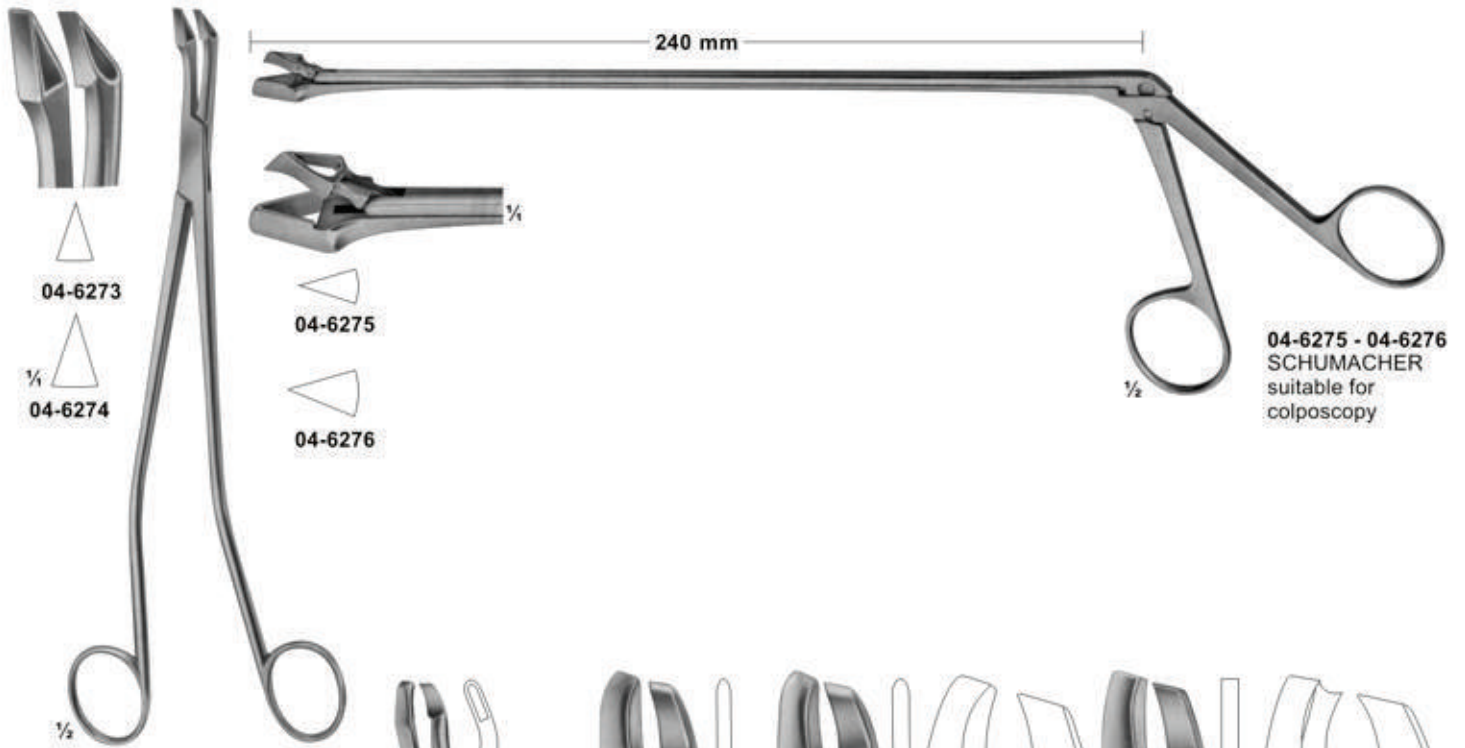

04-6273

04-6274

04-6275

04-6276

04-6275 - 04-6276  
SCHUMACHER  
suitable for  
colposcopy

04-6273 - 04-6274  
SCHUMACHER  
240mm

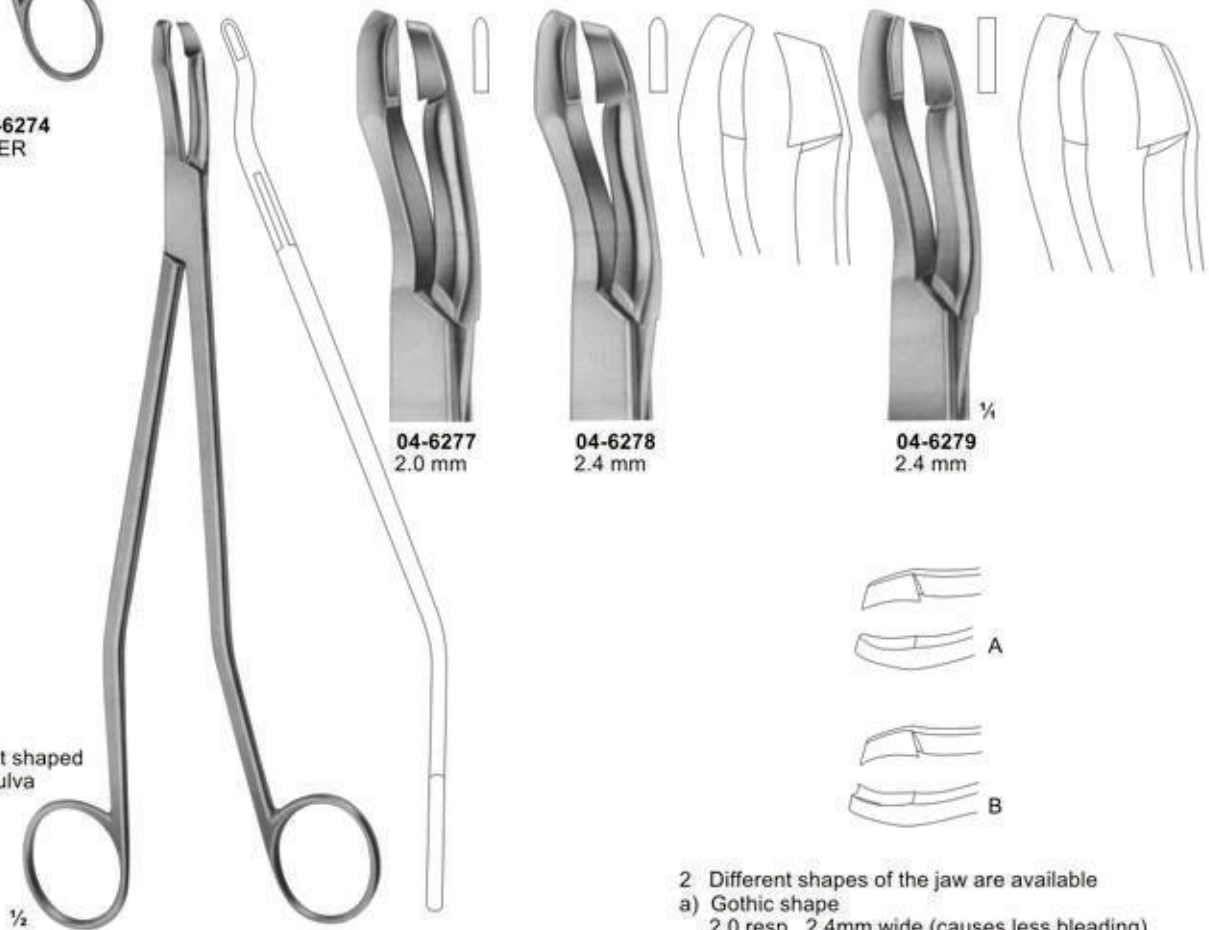

04-6277 - 04-6279  
SEIDL DBP  
Biopsy forceps, bayonet shaped  
for portio, vagina and vulva  
240mm

04-6277  
2.0 mm

04-6278  
2.4 mm

04-6279  
2.4 mm

- 2 Different shapes of the jaw are available
- a) Gothic shape  
2.0 resp 2.4mm wide (causes less bleeding)
- b) Rectangular shape, 2.4mm wide



# Uterine Curettes

*Splenor Surgicals*

Fig	Width	Sharp		Blunt
		Rigid	Malleable	Rigid
1	7.5mm	04-6325	04-6331	04-6337
2	8.5mm	04-6326	04-6332	04-6338
3	10.5mm	04-6327	04-6333	04-6339
4	12.0mm	04-6328	04-6334	04-6340
5	14.0mm	04-6329	04-6335	04-6341
6	15.0mm	04-6330	04-6336	04-6342

04-6325 - 04-6330 Sharp - Rigid  
 04-6331 - 04-6336 Sharp - Malleable  
 04-6337 - 04-6342 Blunt - Rigid

Fig	Width	Blunt - Malleable
0	16.5mm	04-6343
1	18.5mm	04-6344
2	19.5mm	04-6345
3	21.5mm	04-6346
4	23.5mm	04-6347
5	26.0mm	04-6348
6	28.5mm	04-6349

**BUMM**

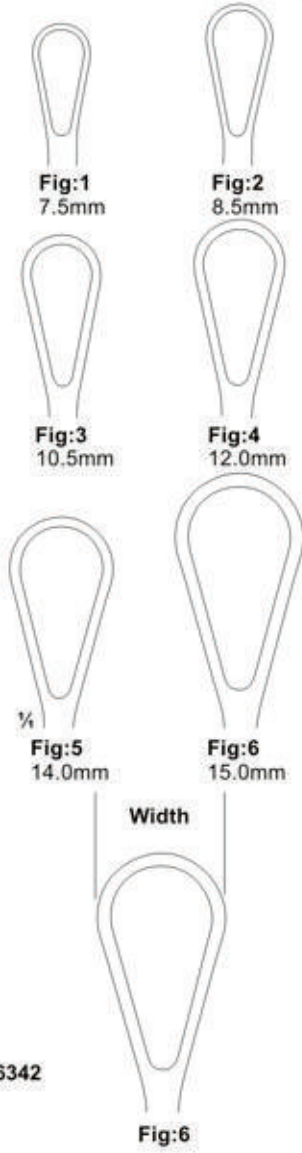
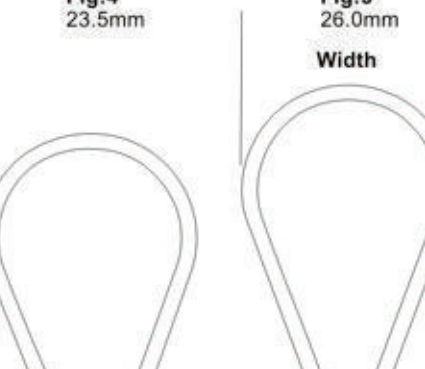
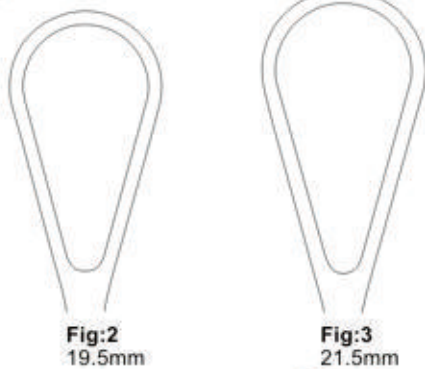
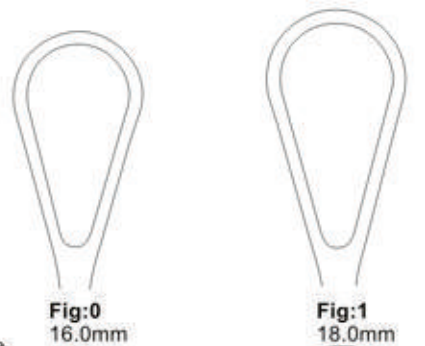



# Uterine Curettes

*Splenor Surgicals*

Fig	Width	Sharp		Blunt
		Rigid	Malleable	Rigid
1	7.5mm	04-6325	04-6331	04-6337
2	8.5mm	04-6326	04-6332	04-6338
3	10.5mm	04-6327	04-6333	04-6339
4	12.0mm	04-6328	04-6334	04-6340
5	14.0mm	04-6329	04-6335	04-6341
6	15.0mm	04-6330	04-6336	04-6342

04-6325 - 04-6330 Sharp - Rigid  
 04-6331 - 04-6336 Sharp - Malleable  
 04-6337 - 04-6342 Blunt - Rigid

Fig	Width	Blunt - Malleable
0	16.5mm	04-6343
1	18.5mm	04-6344
2	19.5mm	04-6345
3	21.5mm	04-6346
4	23.5mm	04-6347
5	26.0mm	04-6348
6	28.5mm	04-6349

**BUMM**

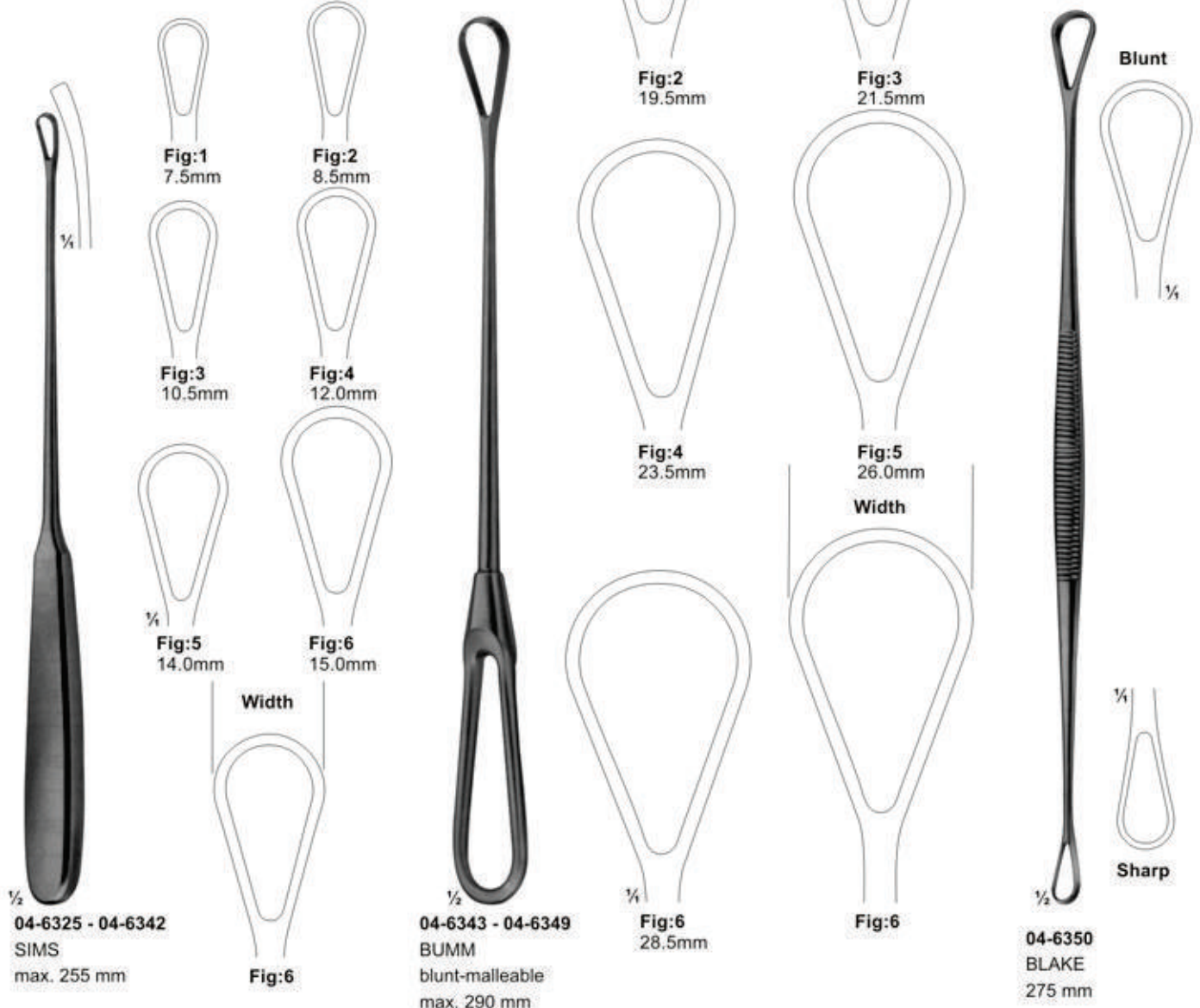



## Vacuum Curettes

**04-6359 - 04-6364**

Suction curettes, stainless steel, fitting hose connection.

Working tips are smoothly rounded off, therefore no danger of perforation.



( suitable for suction biopsy )

**04-6359:** diam 4 mm

**04-6360:** diam 6 mm

**04-6361:** diam 8 mm

**04-6362:** diam 10 mm

**04-6363:** diam 12 mm

**04-6364:** diam 14 mm

**04-6365**

Hose connection inside diam. 11 mm, curved, stainless steel.



**OLIVE**  
∅ 11.15mm



04-6365

04-6366

The new connection between suction curette and hose connection, (**04-6365**) Guarantees quick changing and free turning of the suction curettes on the hose connection.

**04-6366**

Transparent suction hose 1.8 mm long, inside diam 11 mm, outside diam 16.5 mm can be sterilized in an autoclave at 1 bar overpressure ( 120° C )



04-6367

**04-6367**

Strainer for tissues, plastic, for single use only, to be used for histopathological examination.





**04-6368** diam 8 mm  
**04-6369** diam 10 mm  
 BOZEMANN-FRITSCH  
 Uterine Flushing Tube  
 350 mm

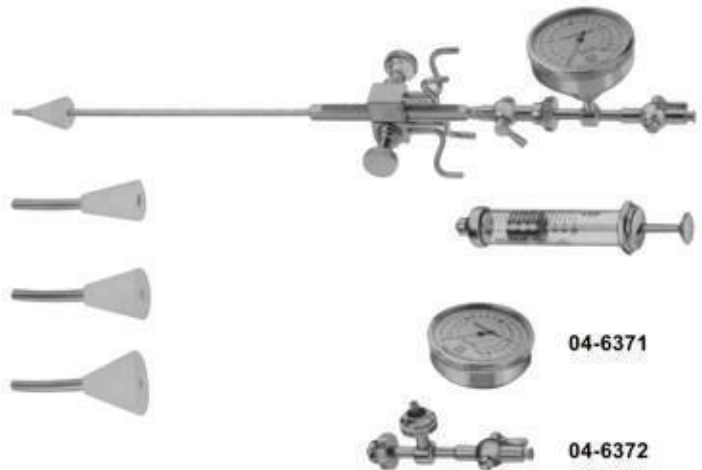

**04-6370**  
 SCHULZE  
 Salpingograph, for utero-salpingography  
 in wooden case, consisting of:  
**04-6371** Manometer only  
**04-6372** Connection only, without manometer  
**04-6373** Uterine cannula with tape without cone  
**04-6374** Cone only, small  
**04-6375** Cone only, medium  
**04-6376** Cone only, large  
**04-6377** Record syringe, 10CC, luer-lock mount.

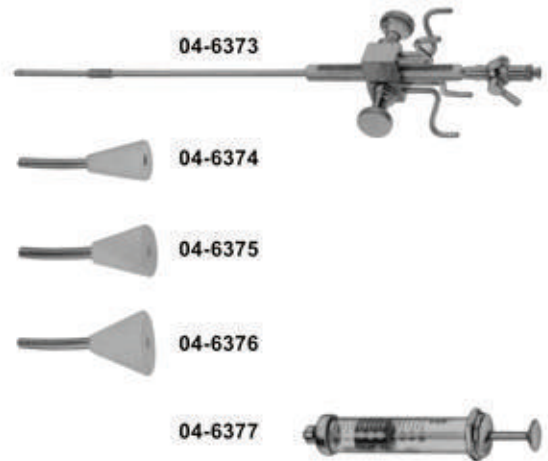

**04-6378**  
 SCHULZE  
 Salpingograph, equipment like(04-6370)  
 but without manometer.



# Obstetrics-Pelvimeters

Splenor Surgicals



**04-6379**  
**THOLE**  
for internal and external measurements, graduated in centimeters



**04-6380**  
**DE LEE**  
graduated in centimeters and inches



**04-6381**  
**COLLIN**  
graduated in centimeters



**04-6382**  
**MARTIN**  
graduated in centimeters



for internal measurements between symphysis and promontory



**04-6383**  
**SCHNEIDER**  
graduated in centimeters

The additional straight arm can be replaced. The pelvimeter with straight arm is used for localisation of the portio vaginalis uteri and of vaginal metastasis.



**04-6384**  
**BREISKY**  
graduated in centimeters



04-6385  
HERFF  
membrane puncturing  
forceps  
255 mm



04-6386  
IOWA  
membrane puncturing  
forceps  
260 mm



# Scissors of Obstetrics, Umbilical cord clamp



**04-6387**  
SCHUMACHER  
Umbilical cord  
scissors  
155 mm



**04-6388**  
Umbilical cord  
scissors  
105 mm

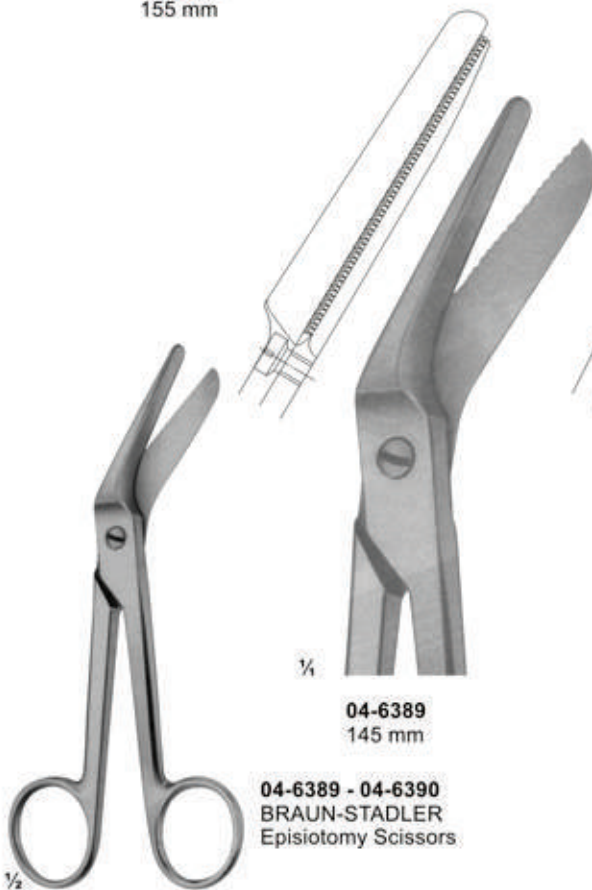

**04-6389**  
145 mm

**04-6389 - 04-6390**  
BRAUN-STADLER  
Episiotomy Scissors

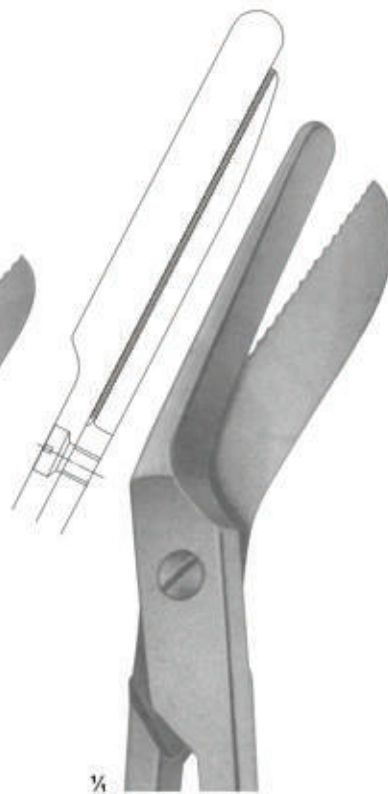

**04-6390**  
200 mm

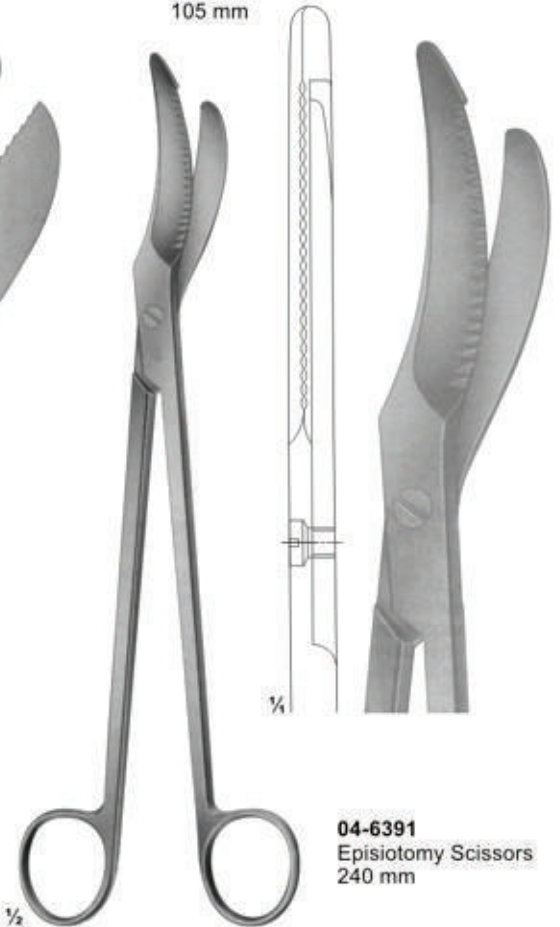

**04-6391**  
Episiotomy Scissors  
240 mm



04-6392  
NAEGELE  
355 mm



04-6393  
NAEGELE  
400 mm



04-6394  
SIMPSON-BRAUN  
305mm



1/3

**04-6395**  
SIMPSON-BRAUN  
350mm

For caesarean section



1/3

**04-6396**  
SIMPSON  
235mm

For caesarean section



1/3

**04-6397**  
WRIGLEY  
250 mm



**04-6398**  
**GREEN-ARMYTAGE**  
Caesarean section haemostatic  
forceps, for edges of the transverse  
incision in the lower segment  
220 mm



**04-6399**  
**WILLETT**  
Scalp Flap forceps  
185 mm



**04-6400**  
**GAUSS**  
Scalp Flap forceps  
260 mm

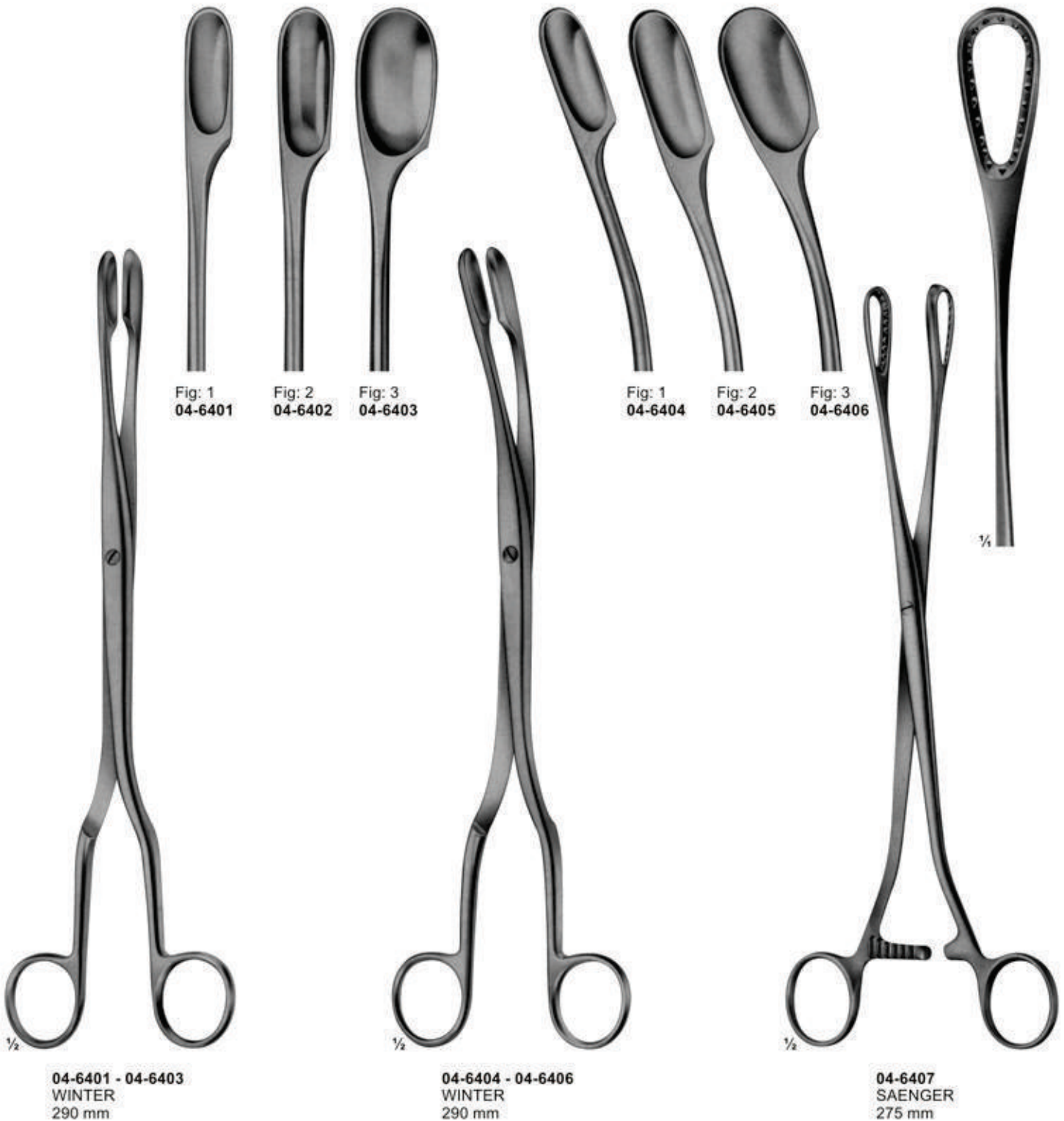

04-6401 - 04-6403  
WINTER  
290 mm

04-6404 - 04-6406  
WINTER  
290 mm

04-6407  
SAENGER  
275 mm





04-6408  
SAENGER  
285 mm



04-6409  
SAENGER  
265 mm



1/4  
04-6410

04-6411

04-6410 - 04-6411  
LEWKOWITZ  
245 mm

Obstetrics-Placenta and Ovum Forceps,  
Perforator, Cranioclast

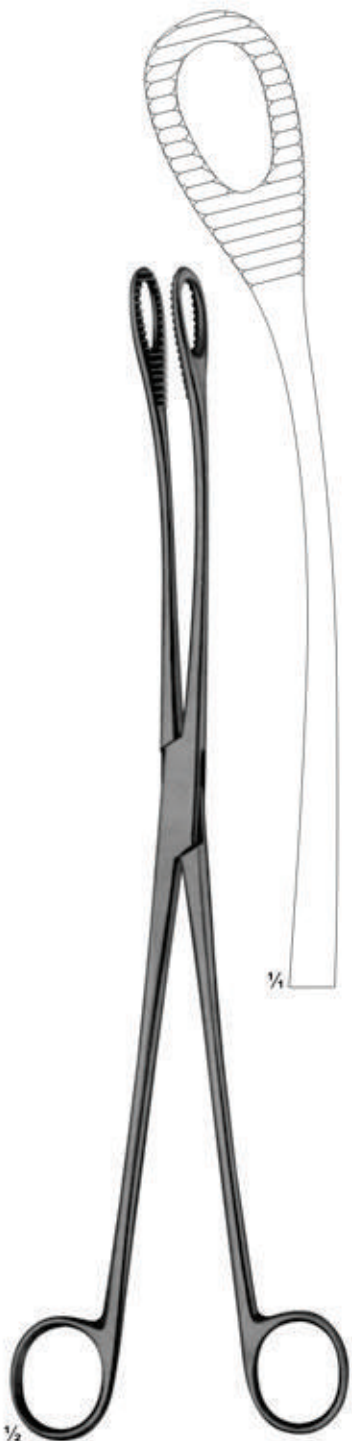

04-6412  
KELLY  
320mm



04-6413  
SMELLIE  
Perforator  
270mm

1 jaws fenestrated



04-6414  
BRAUN  
Cranioclast  
420mm

# Section - 06

  
*Splenor Surgicals*



**Pages 319-392**

- ★ Amputation, Elevators, Raspatories, Saws, Bone Livers, Bone Files & Curettes
- ★ Mallets, Tampers, Chisels, Gauges, Bone Holding Forceps, Bone Rongeurs, Bone Cutting Forceps, Meniscus Instruments
- ★ Wire Extension, Finger Nail Instruments



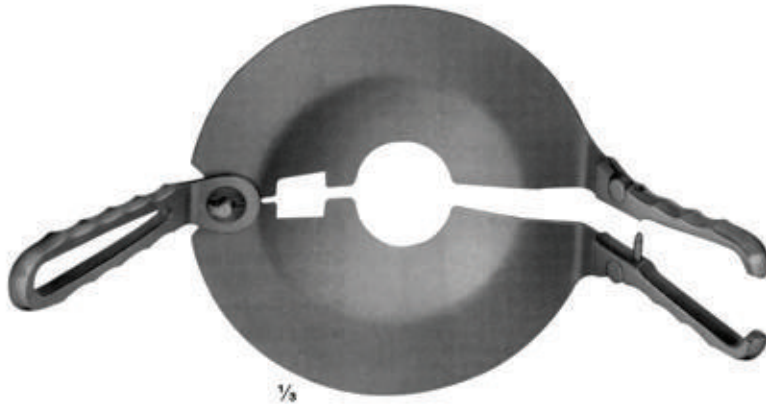

**06-8006**  
PERCY  
removeable handles

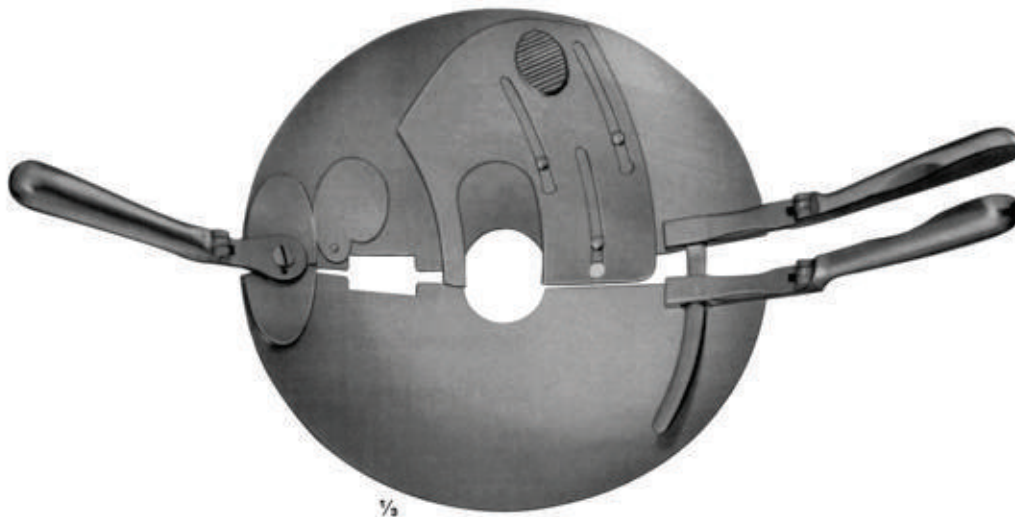

**06-8007**  
PERCY  
reversible handles



1/2

**06-8008**  
**CHARRIERE**  
 Length of blade  
 215 mm  
 complete with one saw  
 blade each(**06-8009** and **06-8010**)  
 350 mm

Spare saw blades, carbon steel  
**06-8009** 12 mm  
**06-8010** 20 mm



1/2

**06-8011**  
**RUST**  
 Length of blade  
 235 mm  
 complete with one saw  
 blade each(**06-8013**, **06-8014**  
 and 2 saw blades **06-8015**)  
 390 mm  
**06-8012** Bow only

Spare saw blades, carbon steel  
**06-8013** 6 mm  
**06-8014** 8 mm  
**06-8015** 12 mm  
**06-8016** 20 mm

# Amputation Saws



1/3

**06-8017**  
**BIER**  
 Length of blade  
 270 mm  
 complete with one saw  
 blade each(**06-8018, 06-8019** and **06-8020**)  
 420 mm

Spare saw blades, carbon steel  
**06-8018** 4 mm  
**06-8019** 6 mm  
**06-8020** 8 mm



1/3

**06-8021**  
**CHARRIERE**  
 Length of blade  
 180 mm  
 Spare saw blade,  
 carbon steel (**06-8022**)  
 270 mm

**06-8023**  
**CHARRIERE**  
 Length of blade  
 240 mm  
 Spare saw blade,  
 carbon steel(**06-8024**)  
 340 mm



1/3

**06-8025**  
**SATTERLEE**  
 Length of blade  
 200 mm  
 Spare saw blade,  
 carbon steel(**06-8026**)  
 200 mm



1/3

**06-8027**  
**LANGENBECK**  
 Length of blade  
 115 mm  
 Metacarpal saw  
 235 mm



**06-8028 - 06-8031**  
**OLIVECRONA**  
**06-8028** 300 mm  
**06-8029** 400 mm  
**06-8030** 500 mm  
**06-8031** 700 mm



**06-8032 - 06-8035**  
**GIGLI**  
**06-8032** 300 mm  
**06-8033** 400 mm  
**06-8034** 500 mm  
 fine, 6 wires twisted  
**06-8035** 500mm  
 coarse, 4 wires twisted



**06-8036**  
**GIGLI**  
 Handle



**06-8037**  
**LEBSCHE**  
 Conductor for  
 wire saws, malleable  
 250 mm





# Elevators and Bone Levers

Splenor Surgicals



06-8038 - 06-8039  
KOENIG  
155 mm



06-8040  
WILLIGER  
165 mm

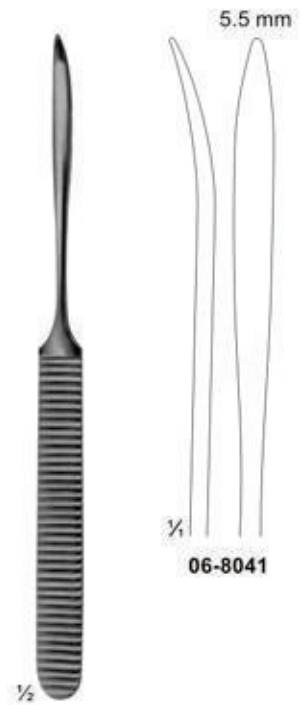

06-8041  
WILLIGER  
170 mm

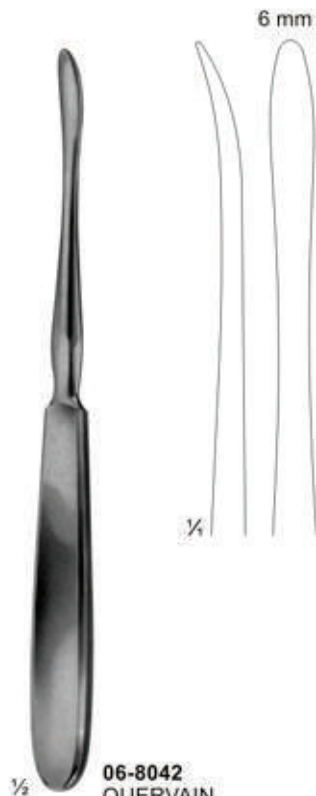

06-8042  
QUERVAIN  
195 mm



06-8043 - 06-8044  
LANGENBECK  
195 mm

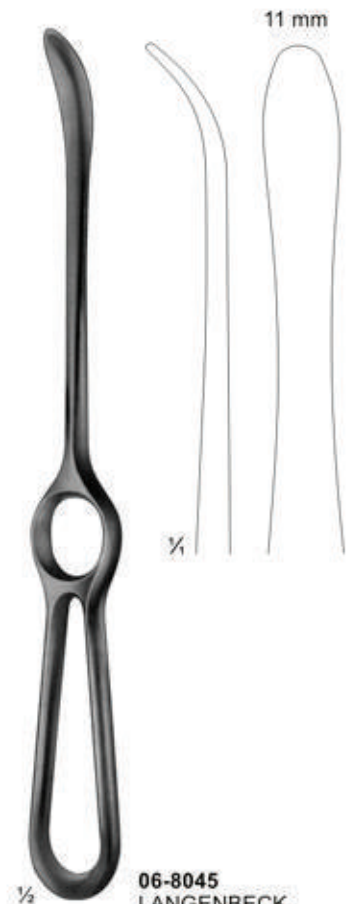

06-8045  
LANGENBECK  
230mm



# Bone Levers

Splenor Surgicals



**06-8046**  
140mm



**06-8047**  
150mm

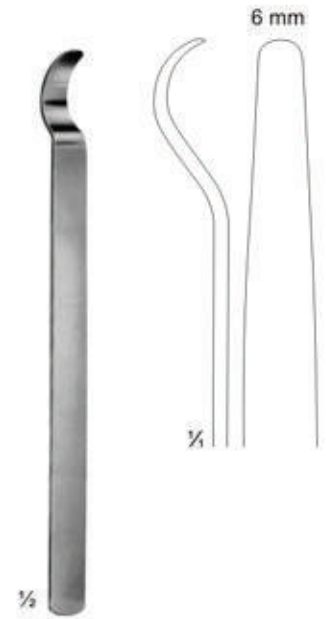

**06-8048**  
150mm

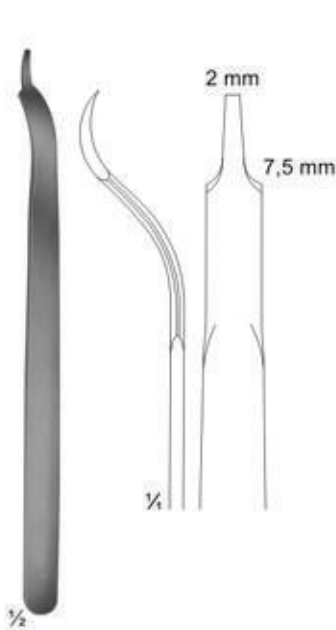

**06-8049**  
BUCK-GRAMCKO  
150mm



**06-8050**  
160mm



**06-8051**  
160mm

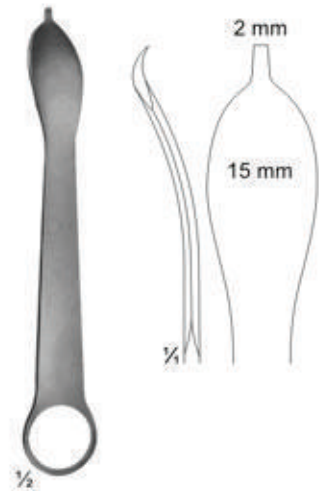

**06-8052**  
125mm



# Bone Levers

Splenor Surgicals



06-8053  
LANE TRETHOWAN  
215mm

06-8054  
LANE  
255mm

06-8055  
LANGE-HOHMANN  
250mm

06-8056 - 06-8057  
LANGE-HOHMANN  
modif  
06-8056 265mm  
06-8057 280mm



# Bone Levers

*Splenor Surgicals*



06-8058  
WAGNER  
220 mm

06-8059  
220 mm

06-8060  
240 mm

06-8061  
240 mm



# Bone Levers

*Splenor Surgicals*

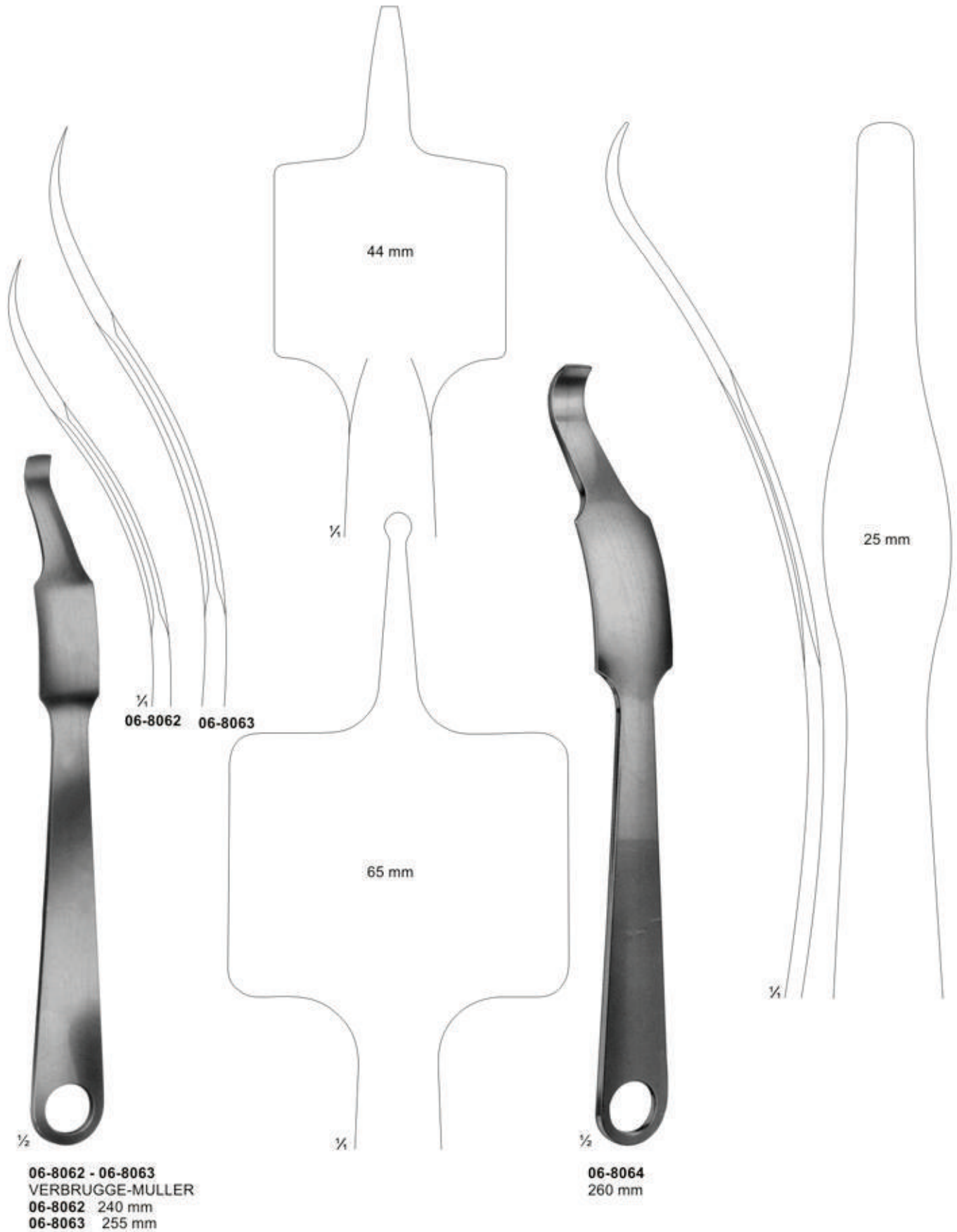

06-8062 - 06-8063  
 VERBRUGGE-MULLER  
 06-8062 240 mm  
 06-8063 255 mm

06-8064  
 260 mm



# Bone Levers

*Splenor Surgicals*

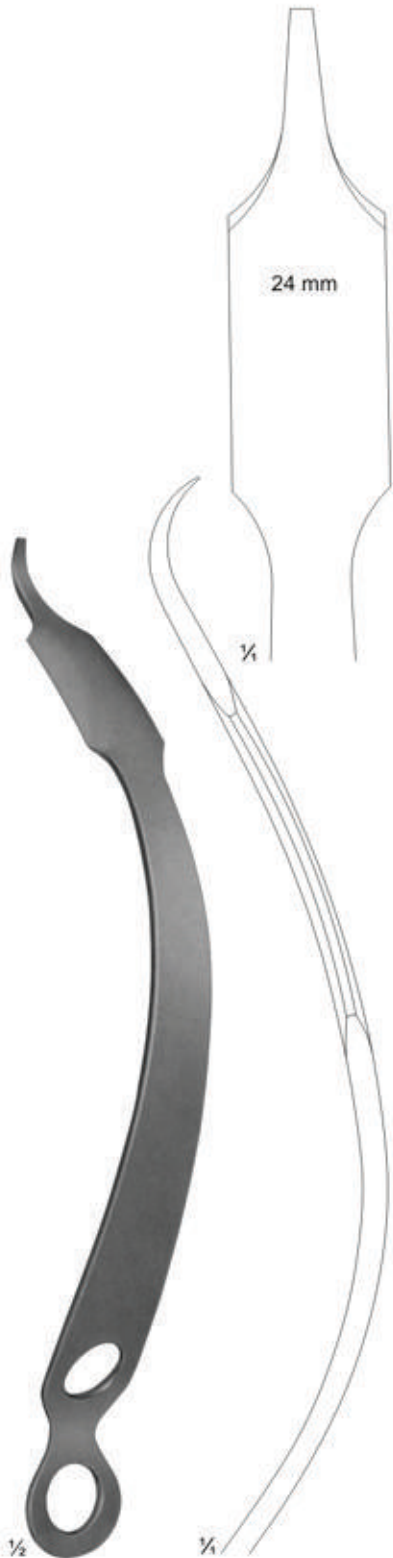

**06-8065**  
HOHMANN-ALDINGER  
270 mm



**06-8066**  
SCHUMACHER mod. WAGNER  
345 mm

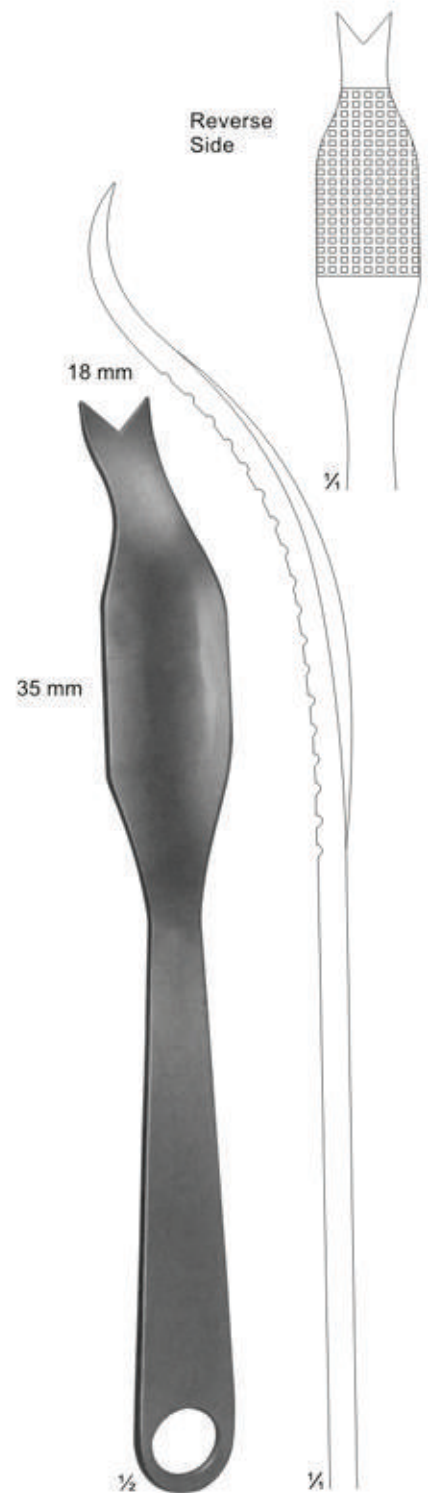

**06-8067**  
SCHUMACHER  
290 mm



**06-8068**  
**TAGER**  
 Bone lever for  
 angle joint operations  
 175 mm



**06-8069**  
**BENNETT**  
 235 mm

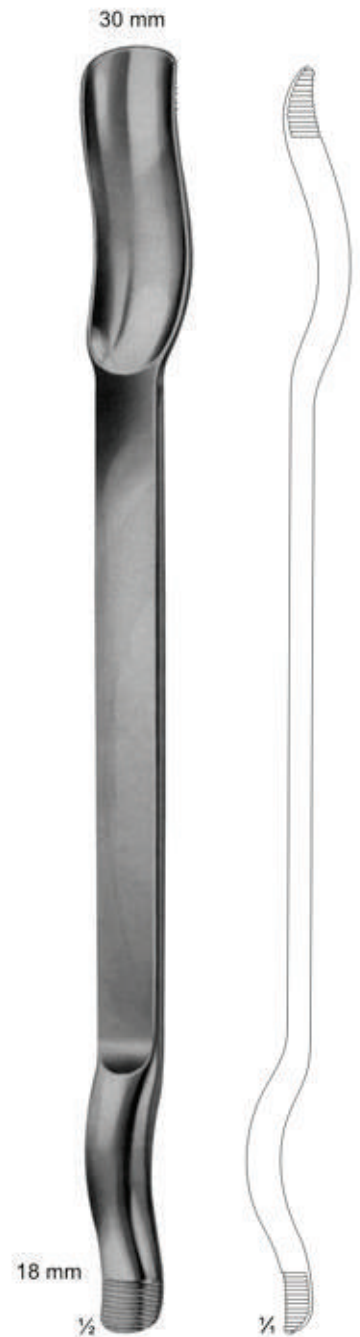

**06-8070**  
**MURPHY-LANE**  
 Luxation lever  
 340 mm



# Raspatories

Splenor Surgicals

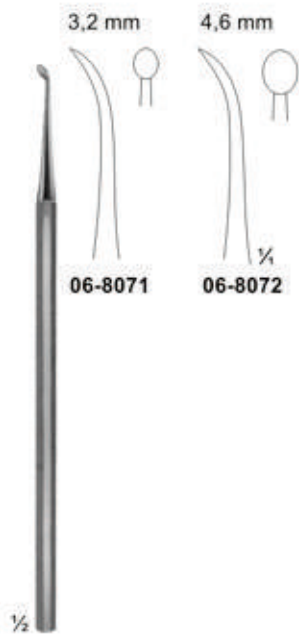

**06-8071 - 06-8072**  
PARTSCH  
150 mm

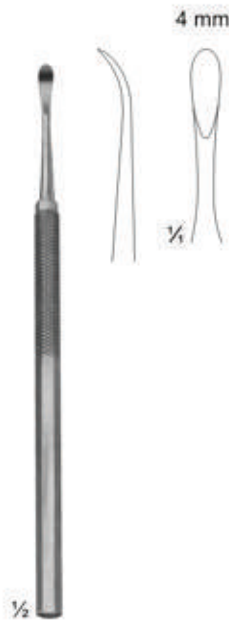

**06-8073**  
PARTSCH mod. LANGE  
145 mm



**06-8074**  
MC KENTY  
155 mm

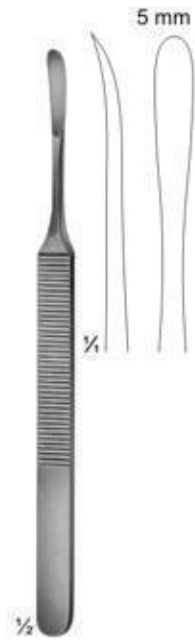

**06-8075**  
KOENIG  
155 mm

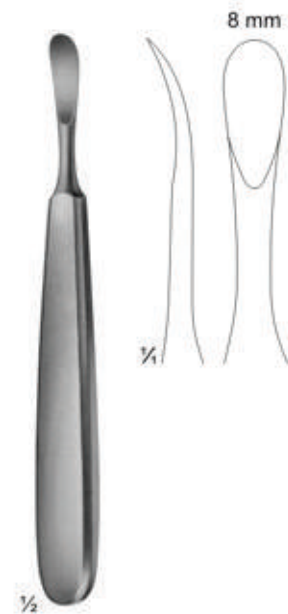

**06-8076**  
TRELAT  
150 mm

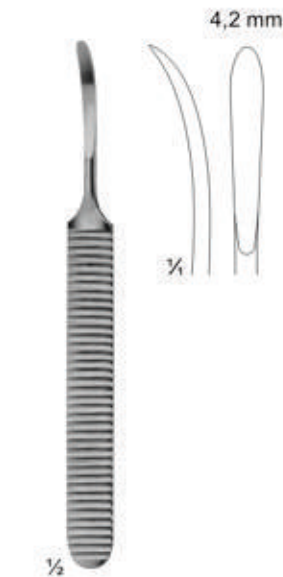

**06-8077**  
WILLIGER  
140 mm



**06-8078**  
WILLIGER  
160 mm

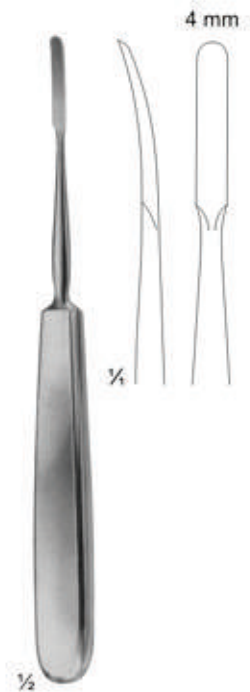

**06-8079**  
JOSEPH  
170 mm





# Raspatories

Splenor Surgicals

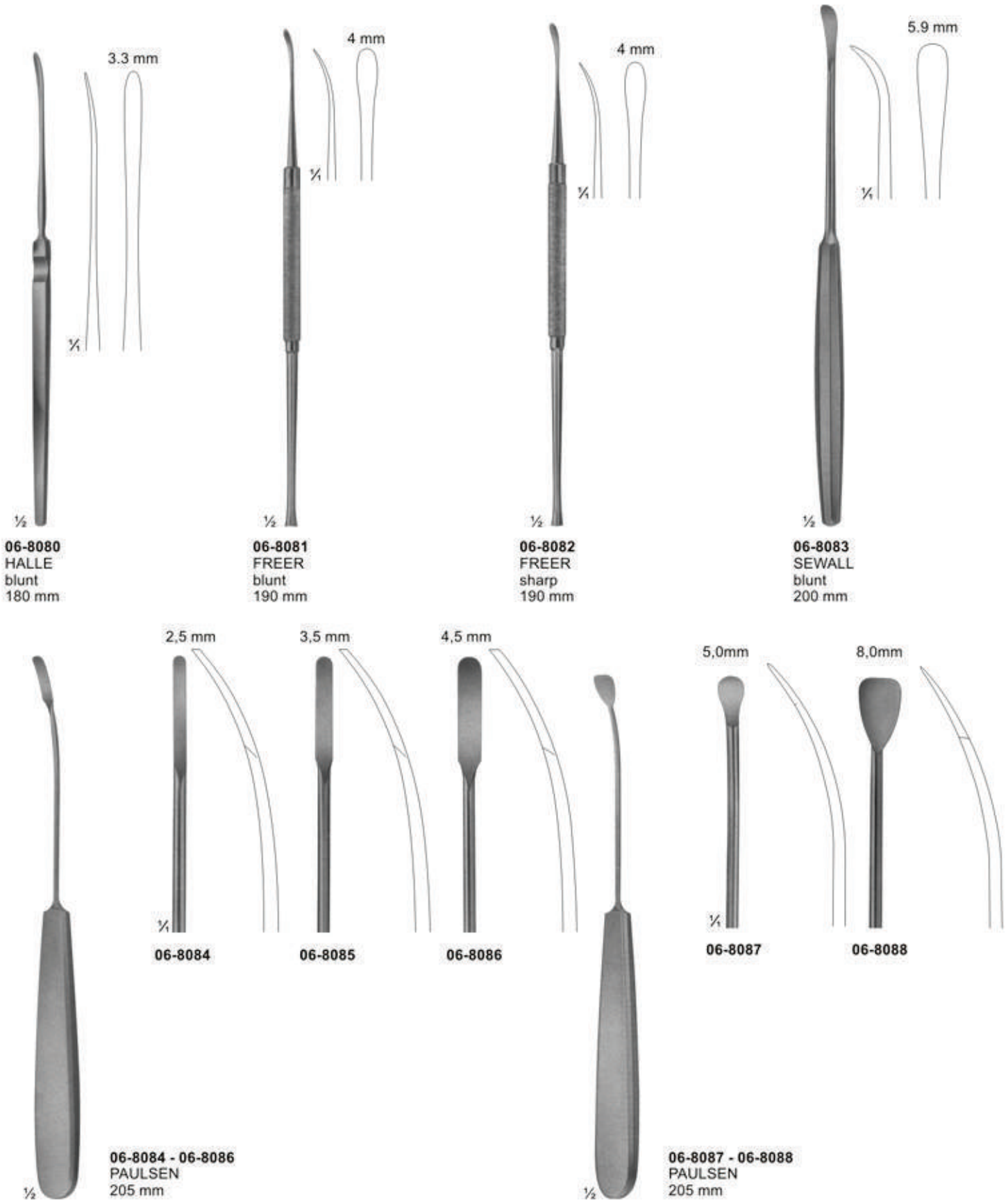



# Raspatories

Splenor Surgicals

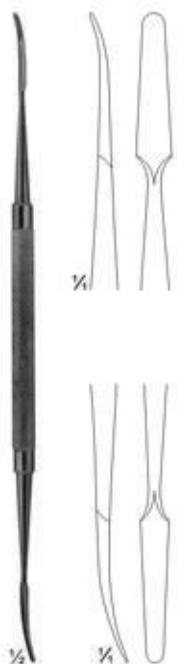

**06-8089**  
KILLIAN  
sharp/blunt  
185 mm



**06-8090**  
HOWARTH  
sharp/blunt  
215 mm

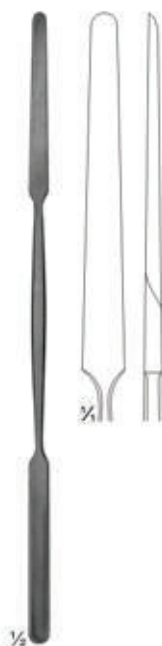

**06-8091**  
KILLIAN  
sharp/blunt  
185 mm

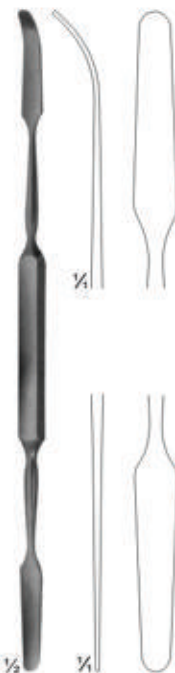

**06-8092**  
MAC DONALD  
blunt/blunt  
185 mm



**06-8093**  
FREER  
sharp/blunt  
185 mm

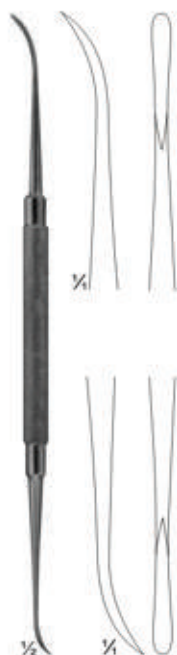

**06-8094**  
FREER-YASARGIL  
sharp/sharp  
185 mm

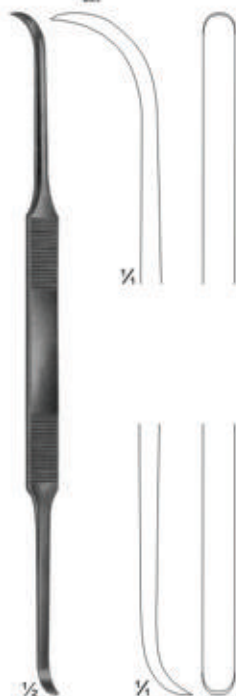

**06-8095**  
COTTLE  
sharp/sharp  
200 mm

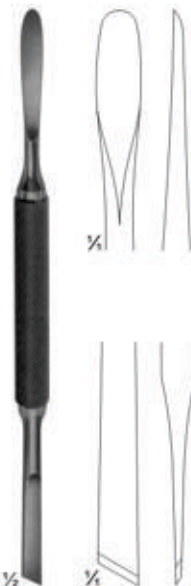

**06-8096**  
MEAD  
sharp/sharp  
165 mm



**06-8097**  
MOLT  
sharp/sharp  
180 mm



# Raspatories

Splenor Surgicals

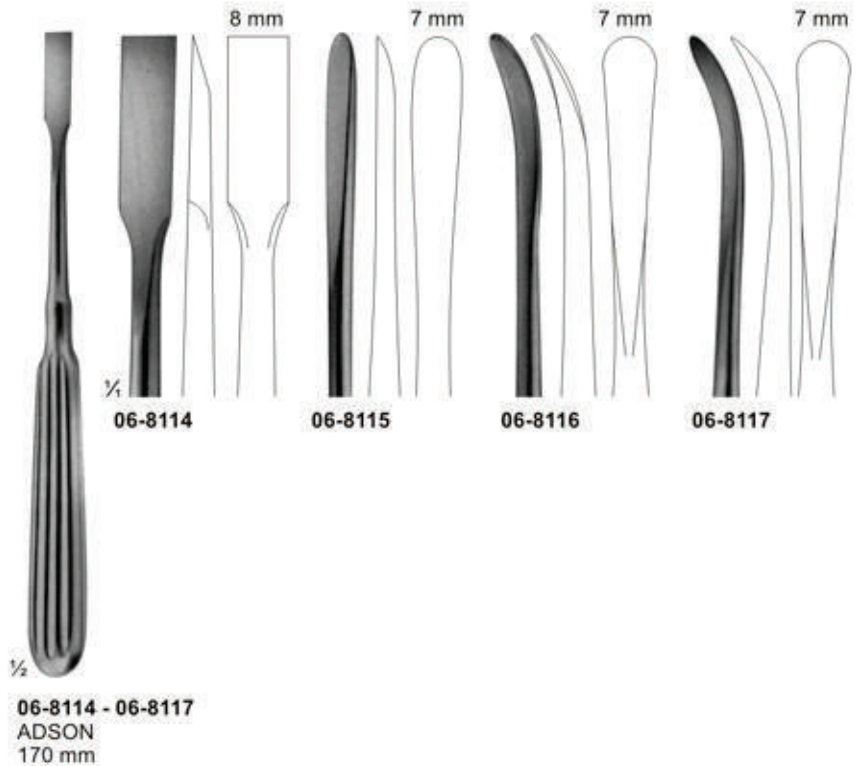
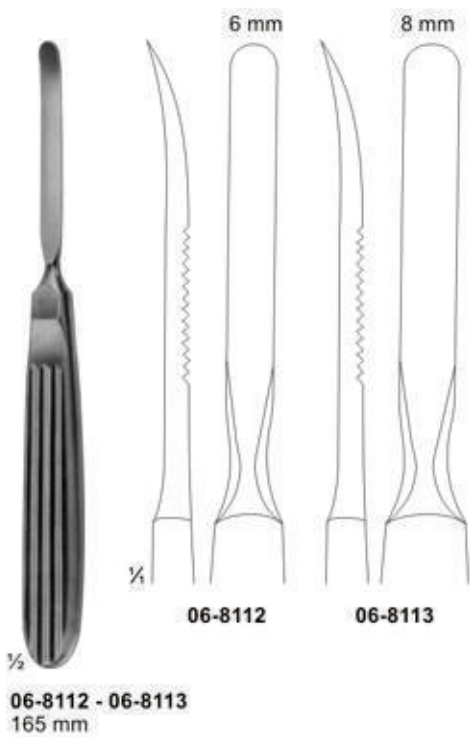
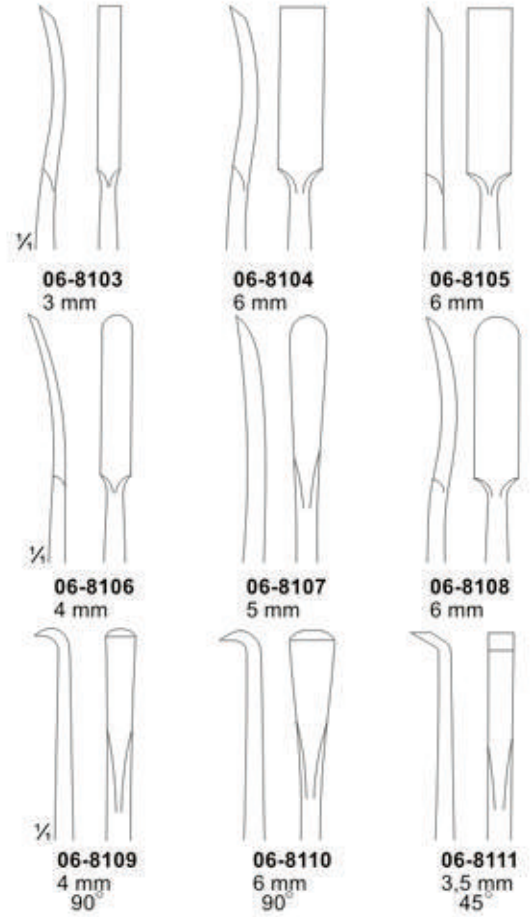
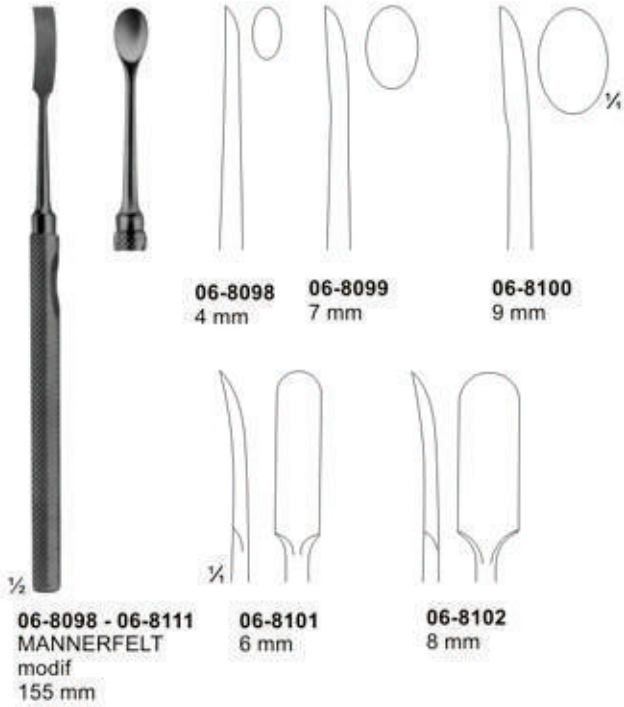



# Raspatories

*Splenor Surgicals*

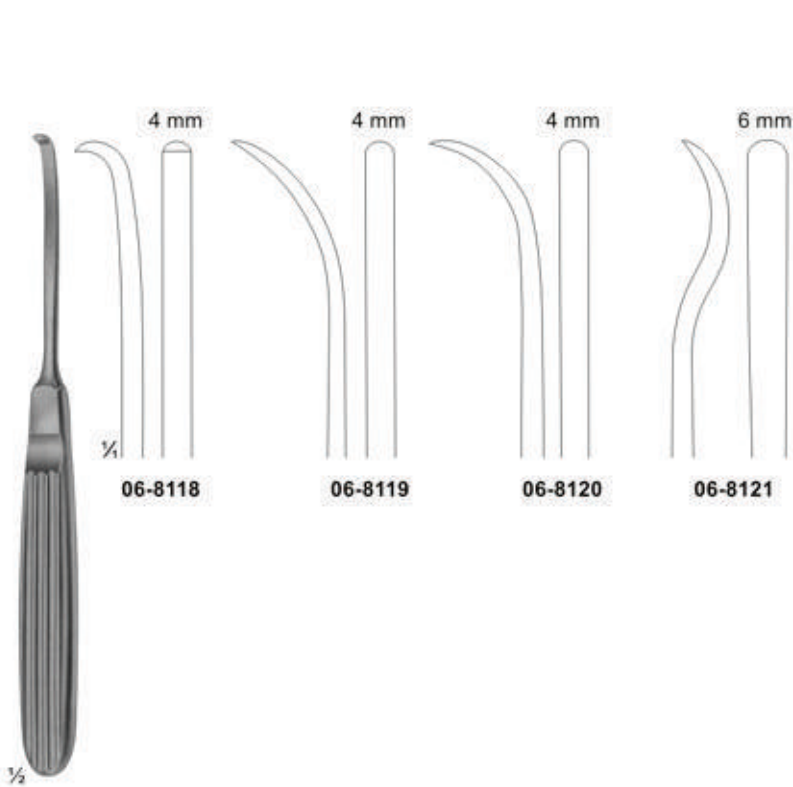

4 mm

4 mm

4 mm

6 mm

06-8118

06-8119

06-8120

06-8121

1/2

06-8118 - 06-8121  
MUEHLING  
170 mm

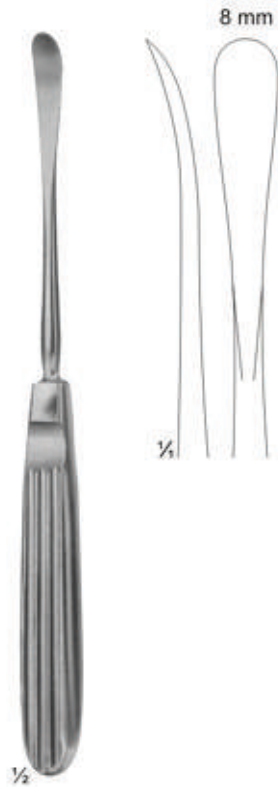

8 mm

1/4

1/2

06-8122  
COTTLE  
195 mm

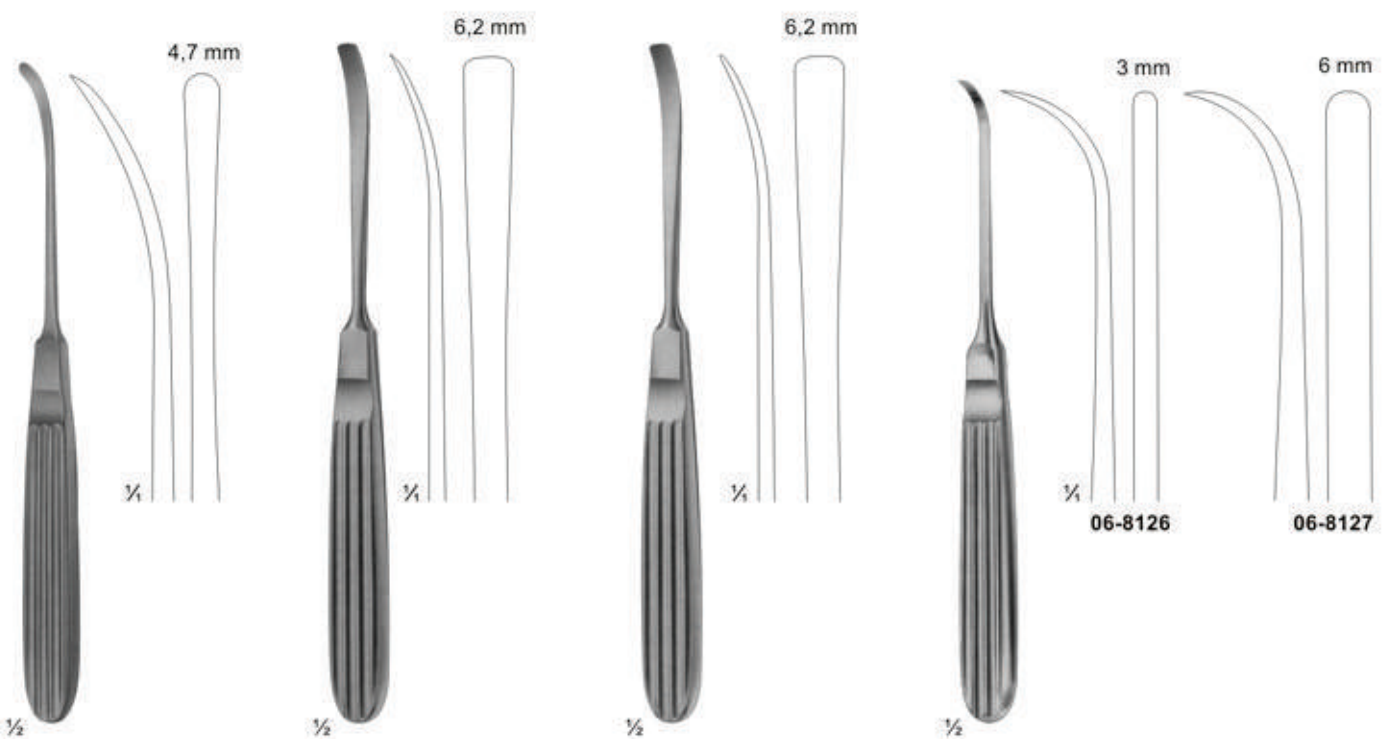

4.7 mm

6.2 mm

6.2 mm

3 mm

6 mm

1/4

1/4

1/4

1/4

06-8126

06-8127

1/2

06-8123  
LANDOLT  
175 mm

1/2

06-8124  
CASPAR  
180 mm

1/2

06-8125  
CASPAR  
180 mm

1/2

06-8126 - 06-8127  
170 mm



# Raspatories

Splenor Surgicals



06-8128  
FARABEU  
140 mm



06-8129  
FARABEU  
140 mm



06-8130  
JANSEN  
165 mm

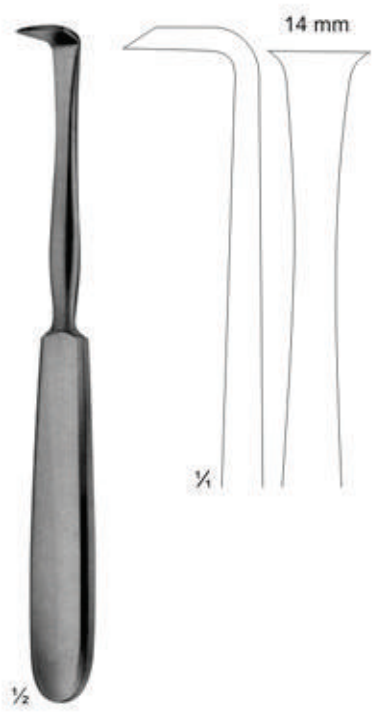

06-8131  
LANGENBECK  
180 mm



06-8132  
SCHNEIDER  
175 mm

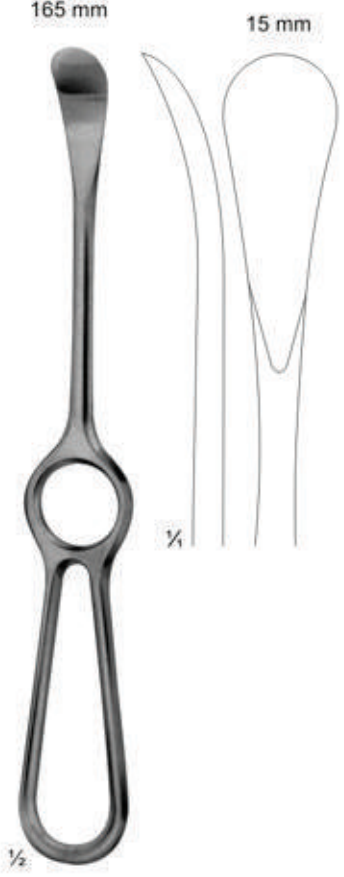

06-8133  
SEDILOT  
215 mm

# Raspatories



06-8134 - 06-8138  
SEMB  
230 mm



06-8143      06-8144



06-8139 - 06-8140  
DOYEN for children  
06-8141 - 06-8142  
for adults 175 mm

06-8143 - 06-8144  
DOYEN  
240 mm



Raspatories with HARTPRESS-handle

*Splenor Surgicals*

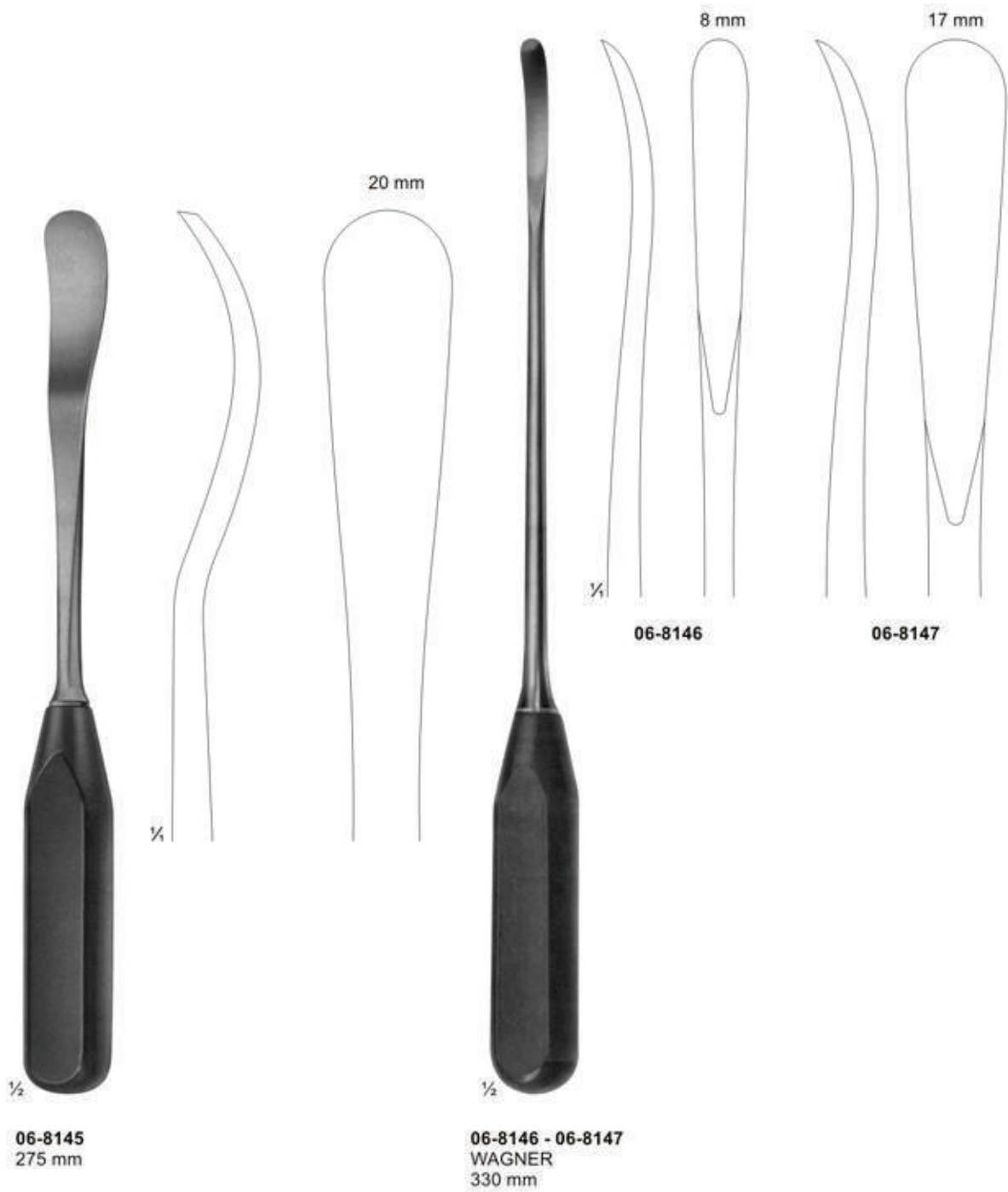



# Bone File and Rasps

Splenor Surgicals



**06-8148**  
JOSEPH  
fine, chequered

**06-8149**  
coarse, chequered  
165 mm



**06-8152**  
MALTZ  
down stroke  
180 mm



**06-8153**  
AUFRICHT  
up stroke

**06-8154**  
down stroke  
220 mm

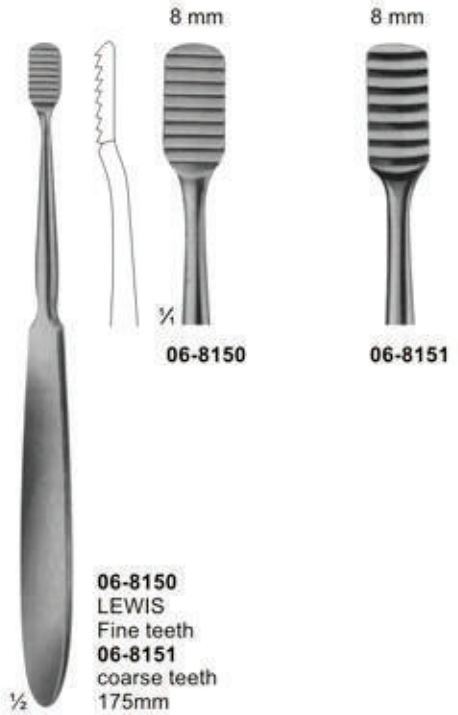
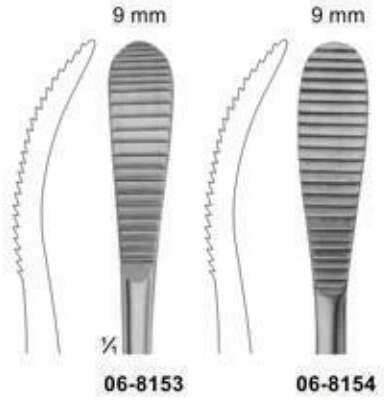

**06-8150**  
LEWIS  
Fine teeth  
**06-8151**  
coarse teeth  
175mm



**06-8155**  
GALLAHER  
190 mm





# Bone File and Rasps, Durogrip Rasps

*Splenor Surgicals*

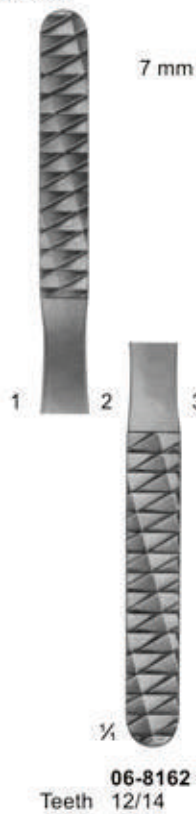
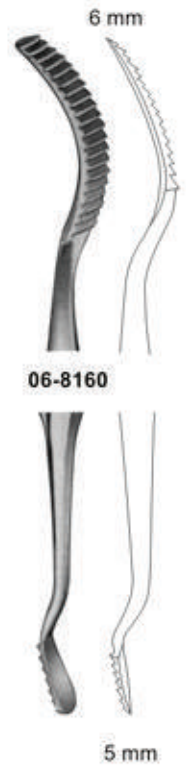



# Bone File and Rasps

*Splenor Surgicals*

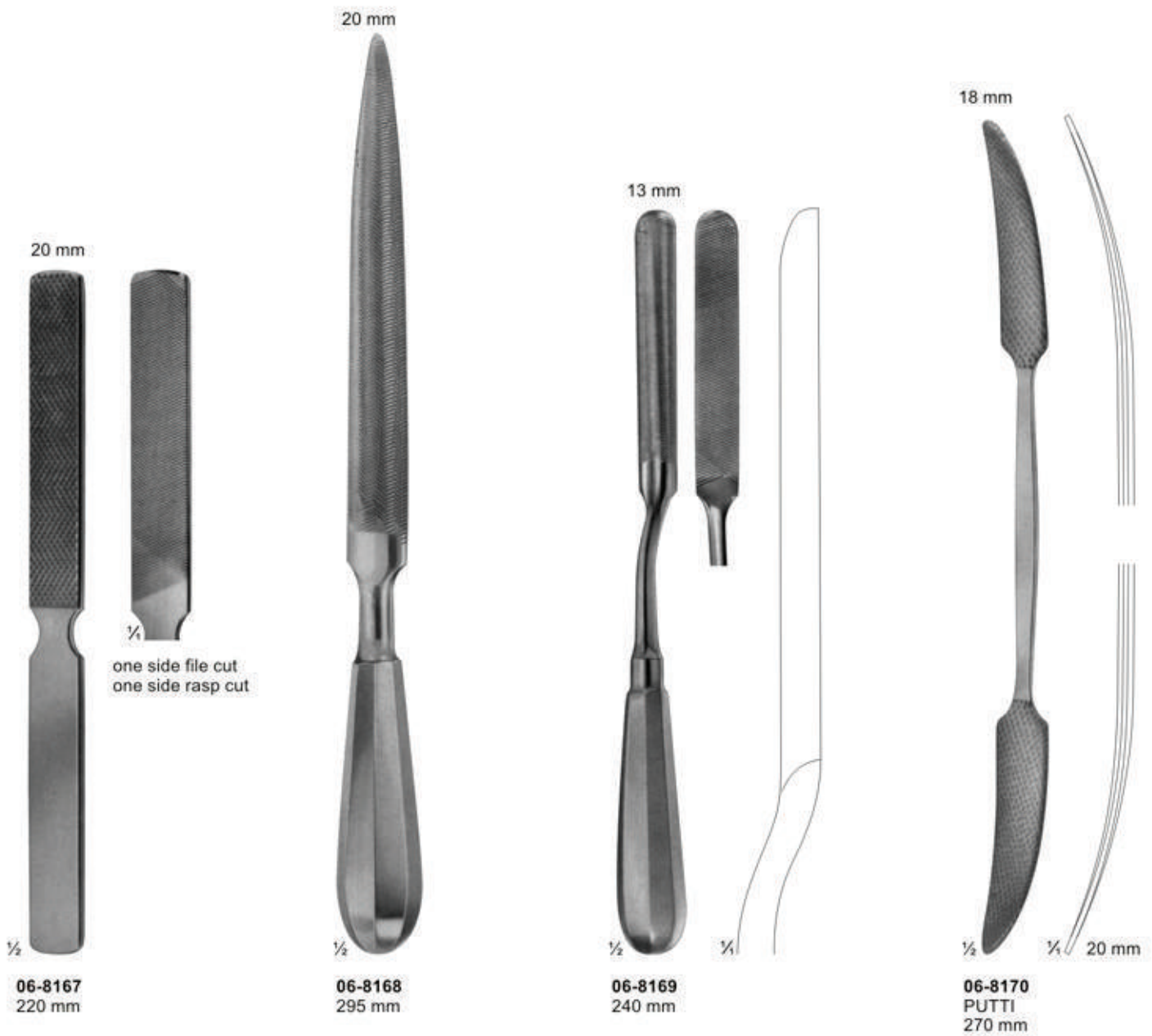



# Bone Currettes

*Splenor Surgicals*



**06-8171**  
JACOBSON  
140 mm



**06-8172**  
MARTINI  
140 mm



**06-8173**  
MARTINI  
140 mm



**06-8174**  
WILLIGER  
145 mm



**06-8175**  
JANSEN  
160 mm



**06-8176**  
BARTH  
180 mm



**06-8177**  
VOLKMANN  
130 mm



**06-8178**  
VOLKMANN  
145 mm



**06-8179**  
VOLKMANN  
170 mm



# Bone Currettes

*Splenor Surgicals*



**06-8180**  
JANSEN  
160 mm



**06-8181**  
HEMINGWAY  
170 mm



**06-8182**  
HEMINGWAY  
175 mm



**06-8183**  
LUCAS  
180 mm



**06-8184**  
LUCAS  
185 mm



**06-8185 - 06-8187**  
KERPEL  
145 mm



**06-8186 - 06-8188**  
KERPEL  
145 mm

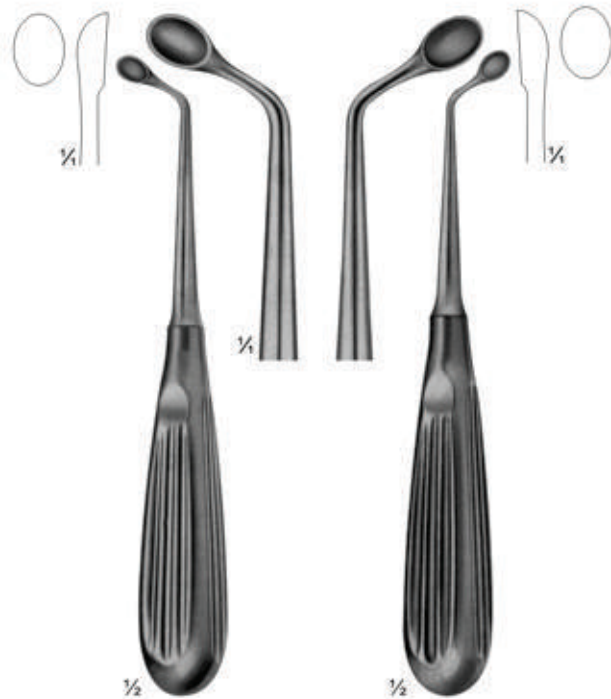

**06-8189**  
UFFENORDE  
170 mm

**06-8190**  
UFFENORDE  
170 mm



# Bone Currettes

# Splenor Surgicals

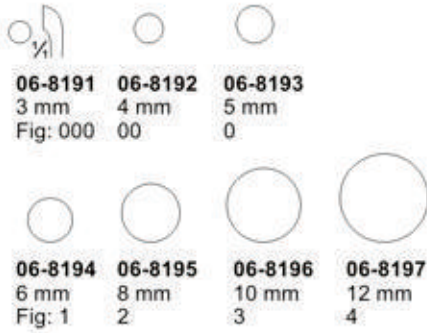

**06-8191 - 06-8197**  
BRUNS  
165 mm

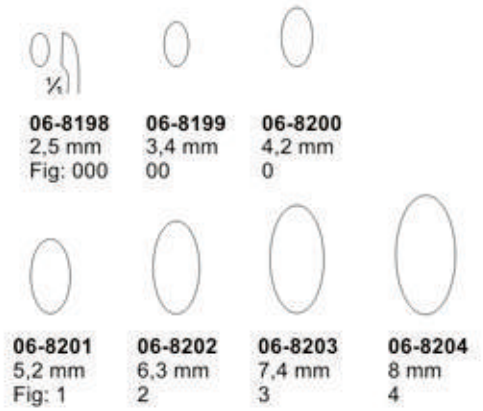

**06-8198 - 06-8204**  
SCHEDE  
170 mm

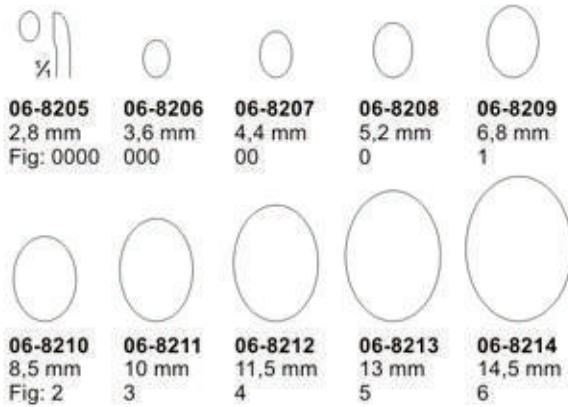

**06-8205 - 06-8214**  
VOLKMANN  
170 mm

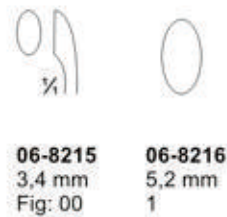

**06-8215 - 06-8216**  
WILLIGER  
170 mm



# Bone Curettes

# Splenor Surgicals



06-8217  
1,8 mm

06-8218  
2,0 mm

06-8219  
2,4 mm

06-8220  
2,6 mm

06-8221  
2,8 mm

06-8217 - 06-8221  
LEMPERT  
215 mm



malleable

06-8222  
4,4 mm  
Fig: 00

06-8223  
5,2 mm  
Fig: 0

06-8224  
6,8 mm  
Fig: 1

06-8222 - 06-8224  
HALLE  
215 mm



06-8225  
2,8 mm  
Fig: 0000

06-8226  
3,6 mm  
Fig: 000

06-8227  
4,4 mm  
Fig: 00

06-8228  
5,2 mm  
Fig: 0

06-8225 - 06-8228  
DAUBENSPECK  
200 mm



06-8229  
3,6 mm  
Fig: 000

06-8230  
4,4 mm  
Fig: 00

06-8231  
5,2 mm  
Fig: 0

06-8232  
6,8 mm  
Fig: 1

06-8229 - 06-8232  
250 mm



06-8233  
3,6 mm  
Fig: 000

06-8234  
4,4 mm  
Fig: 00

06-8235  
5,2 mm  
Fig: 0

06-8236  
6,8 mm  
Fig: 1

06-8233 - 06-8236  
250 mm



06-8237  
3 mm

06-8238  
4 mm

06-8239  
5 mm

06-8237 - 06-8239  
BUSHE 250 mm



# Bone Currettes

# Splenor Surgicals

6 mm

**06-8240**  
TESSIER  
220 mm

**06-8241**  
3,6 mm  
Fig: 000

**06-8242**  
4,4 mm  
Fig: 00

**06-8243**  
5,2 mm  
Fig: 0

**06-8241 - 06-8243**  
SIMON  
235 mm

**06-8244**  
6,8 mm  
Fig: 1

**06-8245**  
8,5 mm  
Fig: 2

**06-8246**  
10 mm  
Fig: 3

**06-8247**  
11,5 mm  
Fig: 4

**06-8248**  
13 mm  
Fig: 5

**06-8249**  
14,5 mm  
Fig: 6

**06-8244 - 06-8249**  
SIMON  
240 mm

**06-8250**  
3,6 mm  
Fig: 000

**06-8251**  
4,4 mm  
Fig: 00

**06-8252**  
5,2 mm  
Fig: 0

**06-8250 - 06-8252**  
CASPAR  
220 mm

**06-8253**  
3,6 mm  
Fig: 000

**06-8254**  
4,4 mm  
Fig: 00

**06-8255**  
5,2 mm  
Fig: 0

**06-8253 - 06-8255**  
CASPAR  
220 mm

**06-8256**  
4 mm

**06-8257**  
5 mm

**06-8258**  
6 mm

**06-8256 - 06-8258**  
CASPAR  
toothed  
220 mm

# Bone Currettes With Hartpress Handle

can be sterilized in a steam sterilizer upto 3 bar over pressure (143 C).

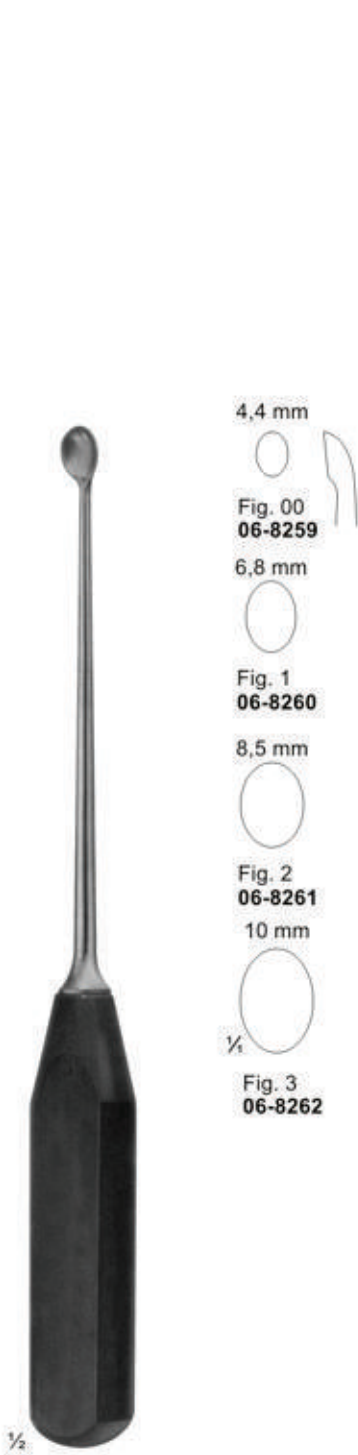

**06-8259 - 06-8262**  
270 mm

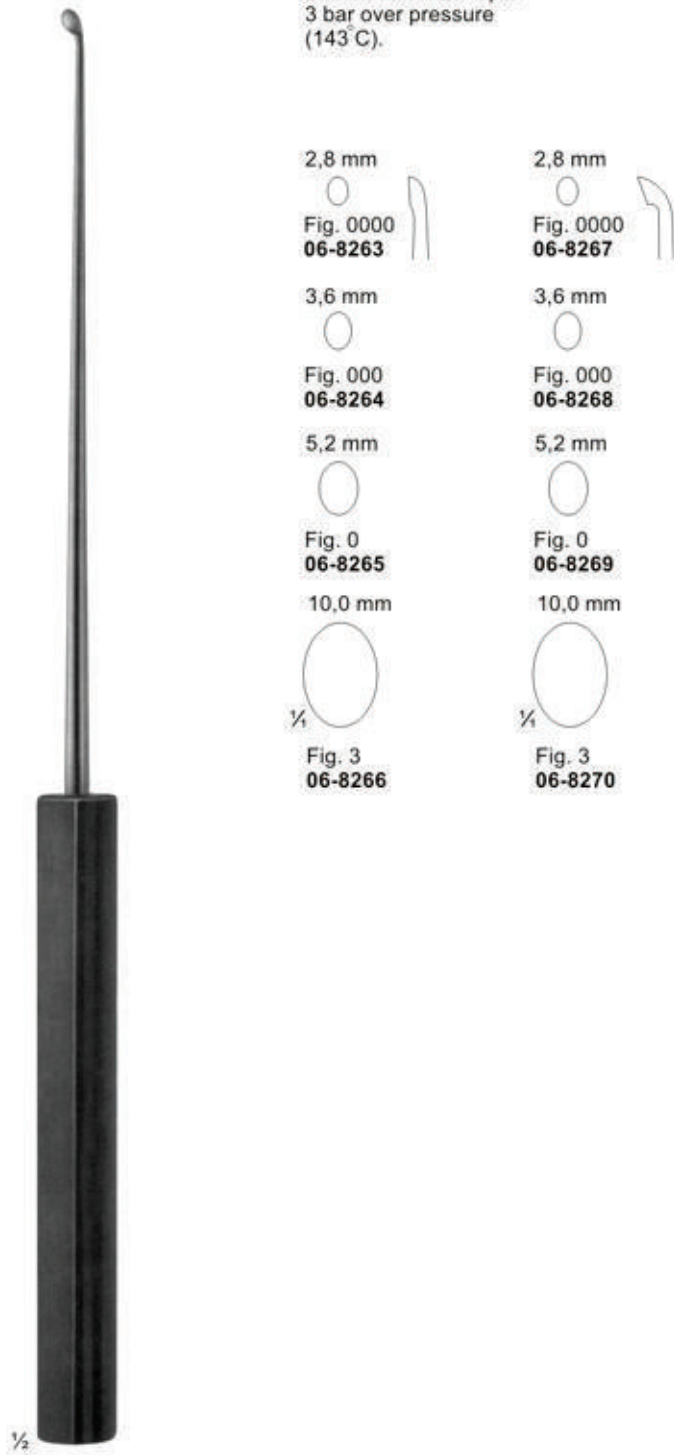

**06-8263 - 06-8270**  
SYPERT  
380 mm





# Punches

Splenor Surgicals

### Angled positions for punchus

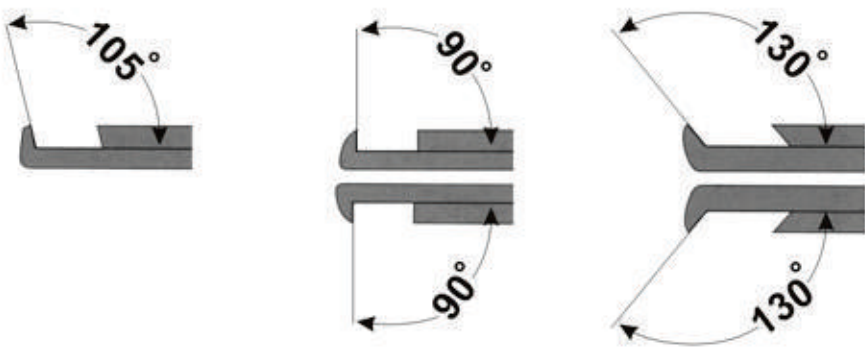

**90° upwards cutting**

65 mm

05-7384  $\frac{1}{4}$

05-7385  $\frac{1}{4}$

$\frac{1}{2}$

05-7384 - 05-7385  
CITELLI  
05-7384 2mm  
05-7385 3.5mm

**90° upwards cutting**

95 mm

$\frac{1}{4}$

$\frac{1}{2}$

05-7386  
CITELLI- BEYER  
1,8 mm



Punches

90° upwards cutting



05-7387  
4 mm



05-7388  
5 mm



05-7387 - 05-7388  
KERRISON

90° upwards cutting

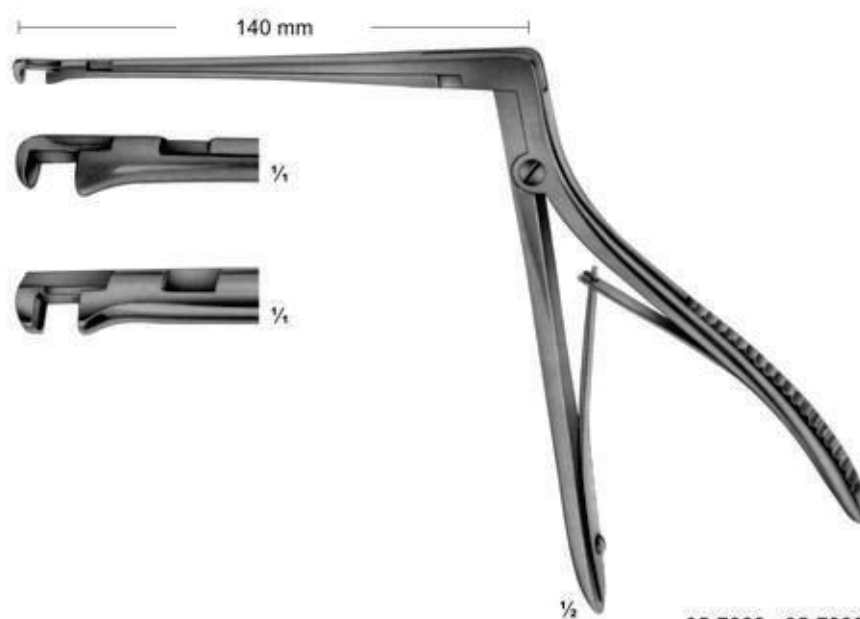

05-7389  
3,3 mm



05-7390  
4,0 mm



05-7389 - 05-7390  
HAJEK-KOFLER



# Punches

**130°** upwards cutting

KERRISON-JACOBY

**05-7391**  
1 mm 

FERRIS-SMITH-KERRISON

**05-7392**  
2 mm 

**05-7393**  
3 mm 

**05-7394**  
4 mm 

**05-7395**  
5 mm 

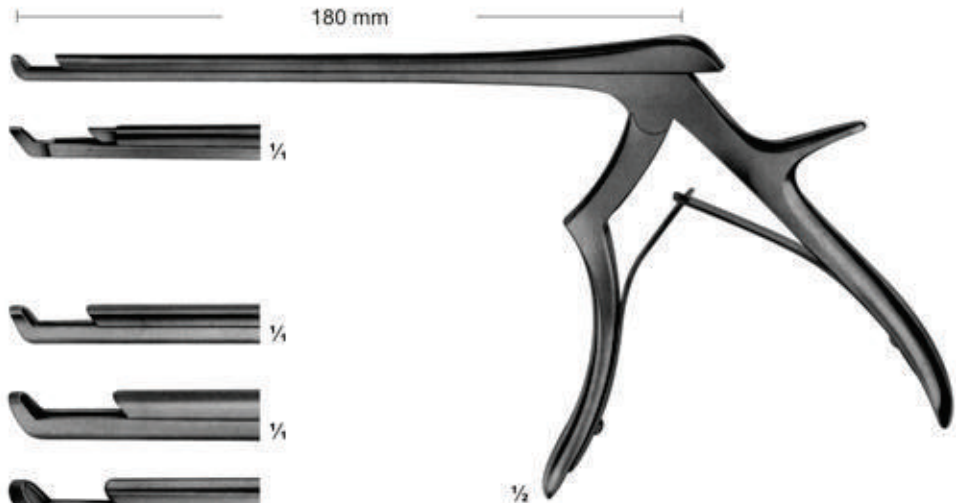

05-7391 - 05-7395

**90°** upwards cutting

KERRISON-JACOBY

**05-7396**  
1 mm 

**05-7397**  
2 mm 

FERRIS-SMITH-KERRISON

**05-7398**  
3 mm 

**05-7399**  
4 mm 

**05-7400**  
5 mm 

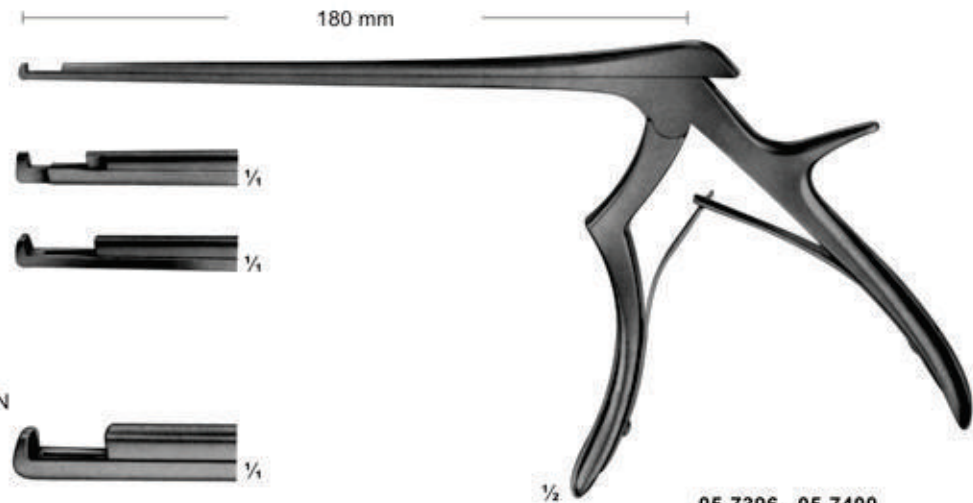

05-7396 - 05-7400



# Rongeurs

Splenor Surgicals

Angled positions for rongeurs

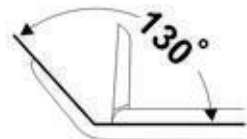
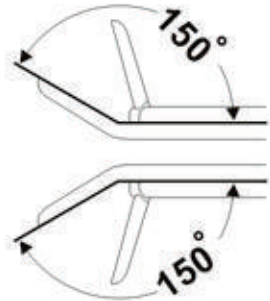

- 05-7401  
3,0 mm
- 05-7402  
3,6 mm
- 05-7403  
4,2 mm
- 05-7404  
4,8 mm
- 05-7405  
5,8 mm

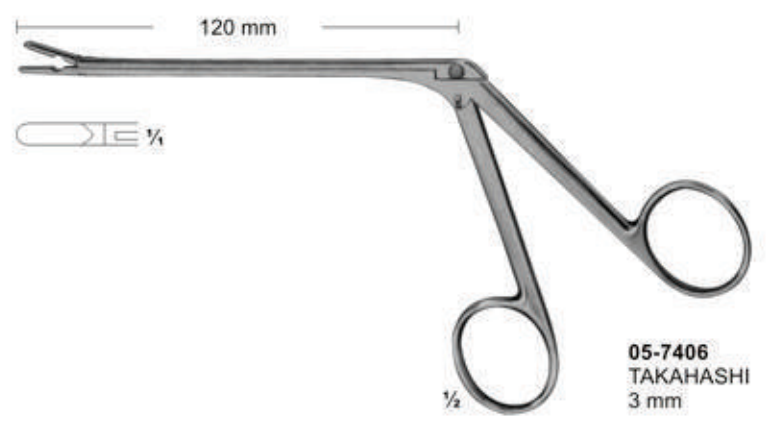
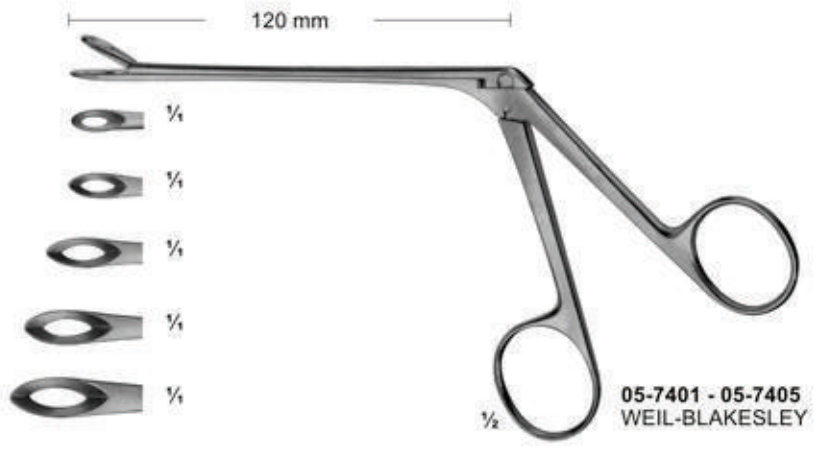

130°

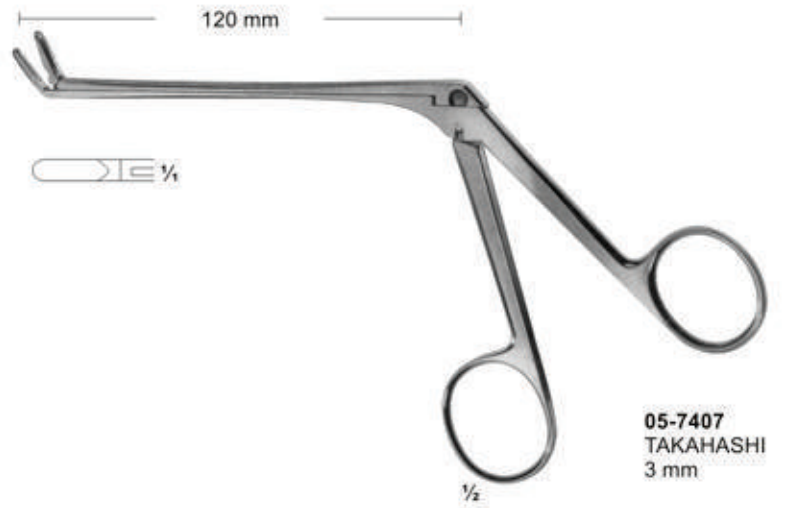

LOVE-GRUENWALD

05-7408  
2 X 10 mm

05-7409  
3 X 10 mm

SPURLING

05-7410  
4 X 10 mm

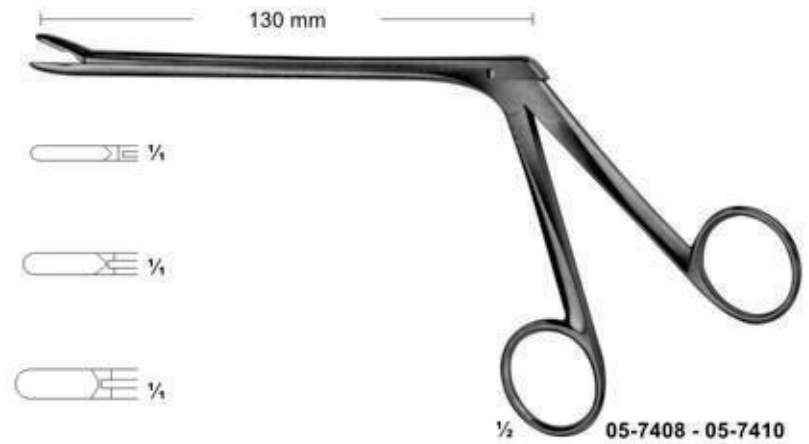

1/2 05-7408 - 05-7410

05-7411  
2 mm

05-7412  
3 mm

05-7413  
4 mm

05-7414  
5 mm

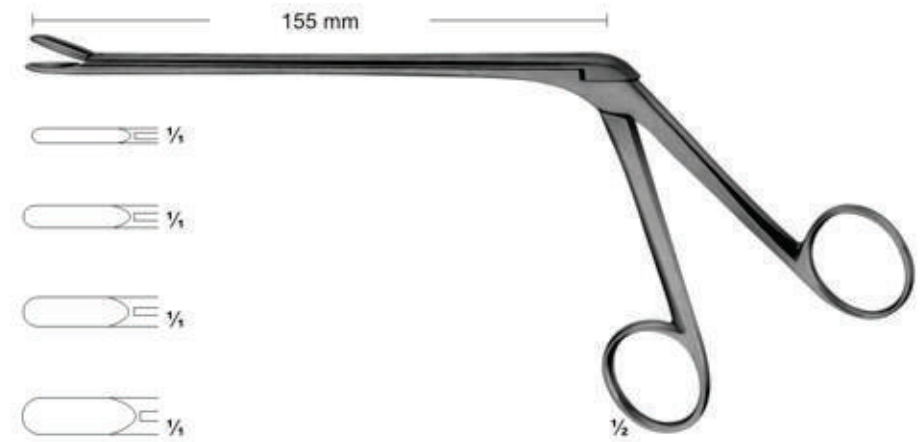

05-7411 - 05-7414  
CASPAR

150°

05-7415  
2 mm

05-7416  
3 mm

05-7417  
4 mm

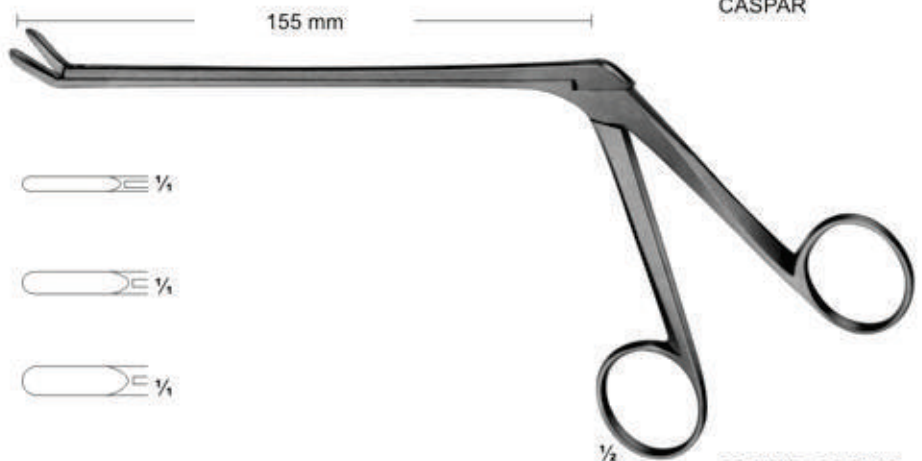

05-7415 - 05-7417  
CASPAR

**150°**

Lower part of jaws movable

**05-7418**  
2 mm

**05-7419**  
3 mm

**05-7420**  
4 mm



**05-7418 - 05-7420**  
CASPAR

Length of shaft 140 mm	Length of shaft 160 mm	Length of shaft 185 mm	size of jaws
<b>05-7421</b>	<b>05-7426</b>	<b>05-7431</b>	2 X12 mm
<b>05-7422</b>	<b>05-7427</b>	<b>05-7432</b>	3 X12 mm
<b>05-7423</b>	<b>05-7428</b>	<b>05-7433</b>	4 X14 mm
<b>05-7424</b>	<b>05-7429</b>	<b>05-7434</b>	5 X14 mm
<b>05-7425</b>	<b>05-7430</b>	<b>05-7435</b>	6 X16 mm

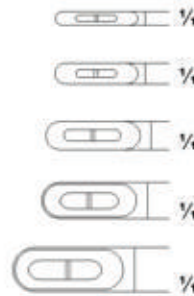

**05-7421 - 05-7435**  
CASPAR

**150°**

Length of shaft 140 mm	Length of shaft 160 mm	Length of shaft 185 mm	size of jaws
<b>05-7436</b>	<b>05-7439</b>	<b>05-7442</b>	3 X12 mm
<b>05-7437</b>	<b>05-7440</b>	<b>05-7443</b>	4 X14 mm
<b>05-7438</b>	<b>05-7441</b>	<b>05-7444</b>	5 X14 mm



**05-7436 - 05-7444**  
CASPAR

150°

Lower part of jaw movable

Length of shaft 140 mm	Length of shaft 160 mm	Length of shaft 185 mm	size of jaws
05-7445	05-7447	05-7449	3 X 12 mm
05-7446	05-7448	05-7450	4 X 14 mm

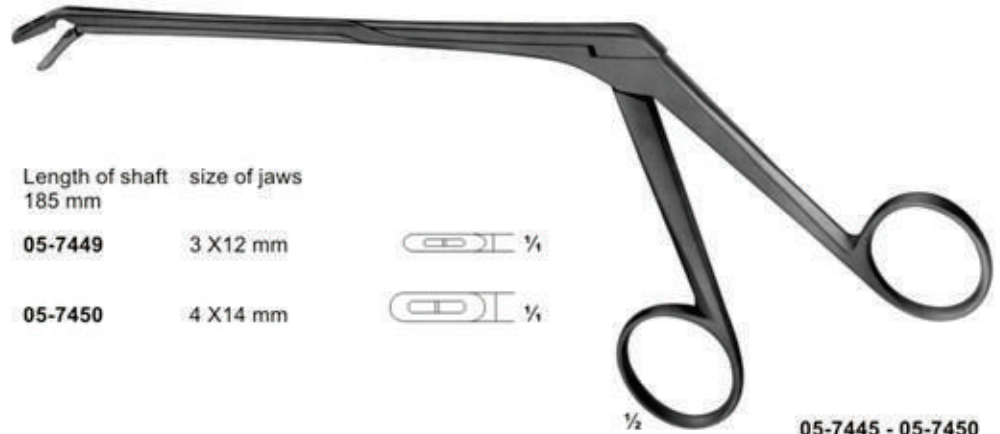

05-7445 - 05-7450  
CASPAR

05-7451  
2 X 10 mm  
CUSHING

05-7452  
3 X 10 mm  
LOVE-GRUENWALD

05-7453  
4 X 10 mm  
SPURLING

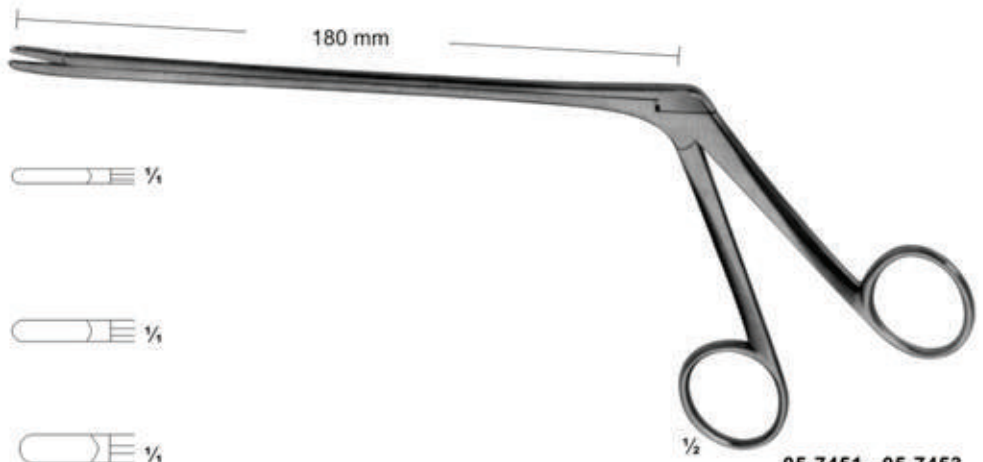

05-7451 - 05-7453

150°

05-7454  
3 X 10 mm  
LOVE-GRUENWALD

05-7455  
4 X 10 mm  
SPURLING



05-7454 - 05-7455

# Rongeurs

**150°**

Upper part of jaw  
movable

**05-7456**  
3 X 10 mm  
LOVE-GRUENWALD

**05-7457**  
4 X 10 mm  
SPURLING

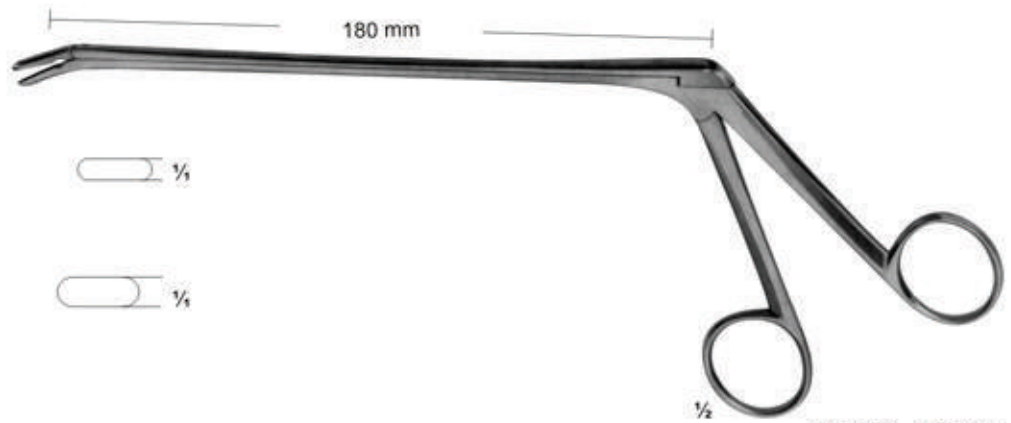

05-7456 - 05-7457

**05-7458**  
∅ 7 mm

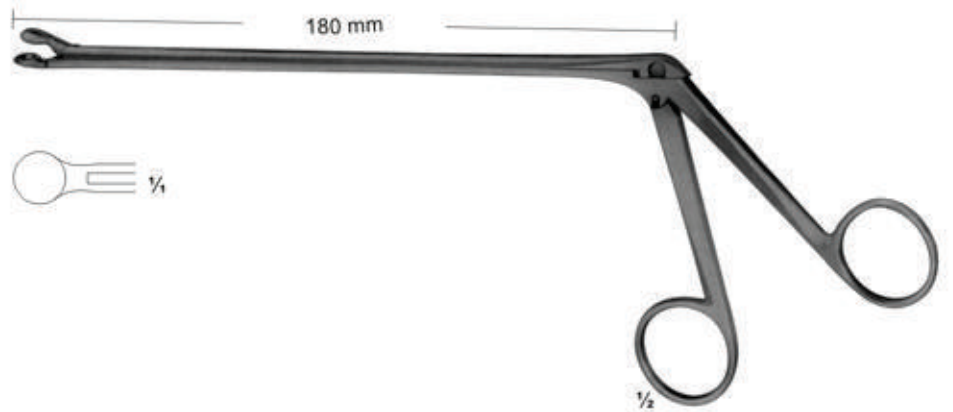

05-7458  
OLDBERG

**05-7459**  
YASARGIL  
∅ 2,2 mm

**05-7460**  
YASARGIL  
∅ 3,5 mm



05-7459 - 05-7460





Rongeurs

Splenor Surgicals

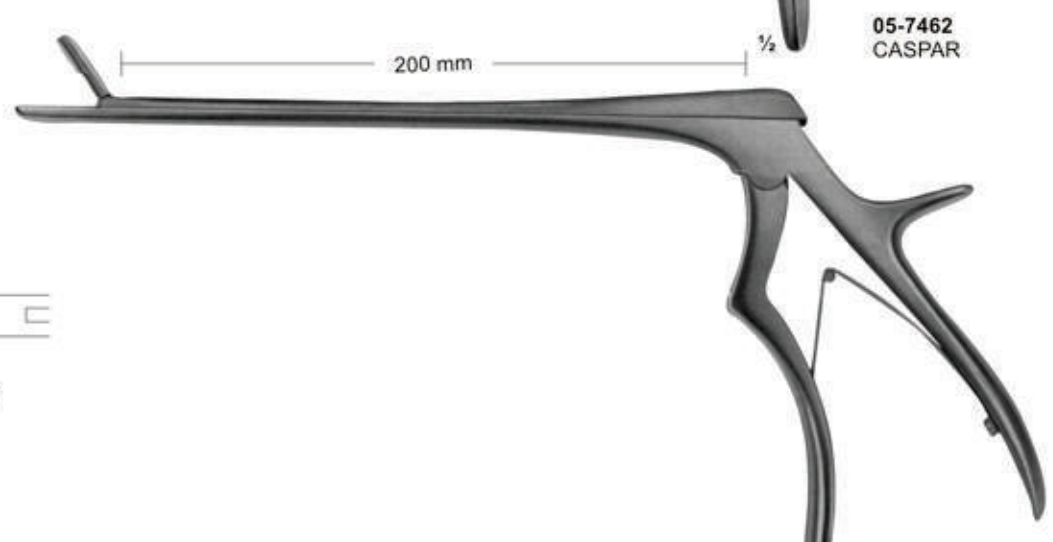
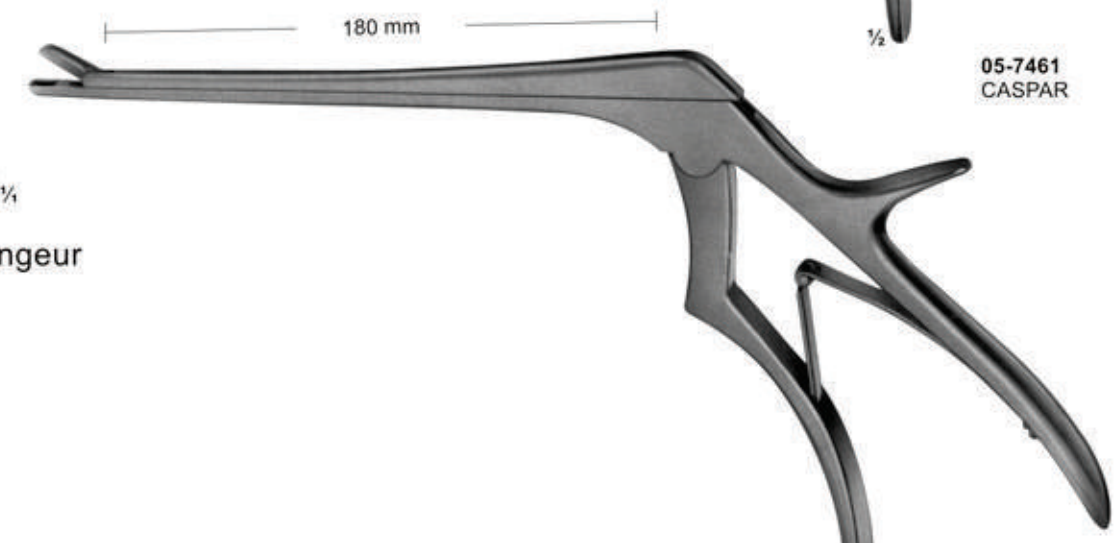
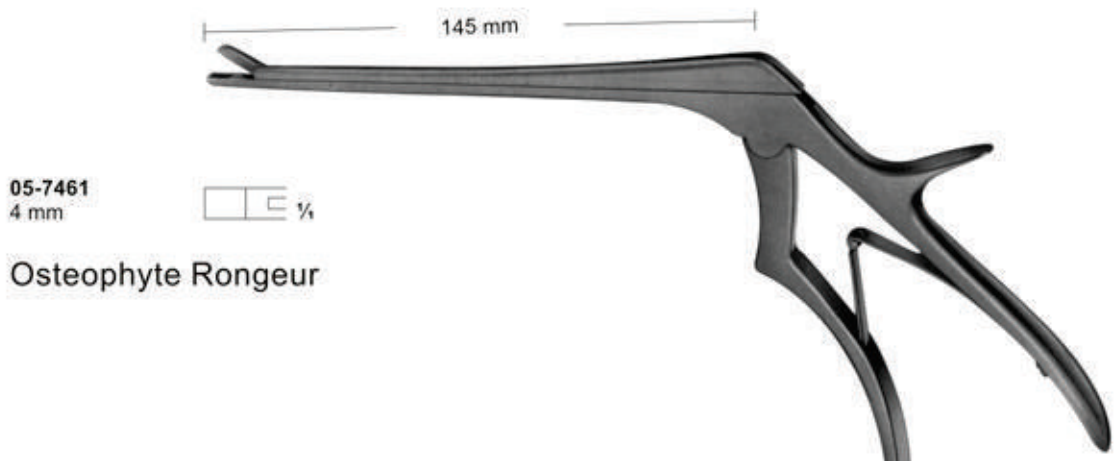

05-7461  
CASPAR

05-7462  
CASPAR

05-7463  
WAGNER

Mallets Weight Refer To The Heads Of  
The Mallets



∅ 20 mm

½

**06-8271**  
MEAD  
185 g  
with interchangeable  
plastic disks  
190 mm  
**06-8272**  
pair of spare disks



∅ 25 mm

½

**06-8273**  
140 g  
with interchangeable  
plastic disks  
185 mm  
**06-8274**  
pair of spare disks



∅ 30 mm

½

**06-8275**  
COTTLE  
240 g  
1 Side flat  
1 Side convex  
185 mm



∅ 22 mm

½

**06-8276**  
165 g  
lead filled head  
190 mm

# Mallets, Weights Refer To The Heads Of The Mallets



**06-8277**  
HAJEK  
140 g  
220 mm



**06-8278**  
215 g  
with interchangeable  
plastic disks  
245 mm  
**06-8279**  
pair of spare disks

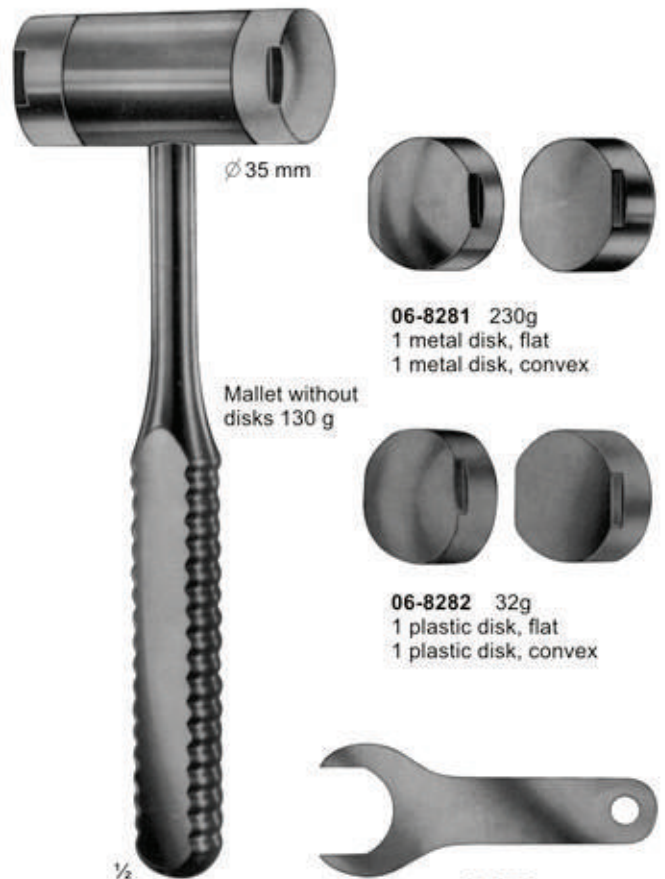

**06-8280 - 06-8283**  
WAGNER  
complete with:  
1 pair of metal disks (**06-8281**) and  
1 pair of plastic disks (**06-8282**) and  
1 wrench (**06-8283**)  
235 mm



**06-8281** 230g  
1 metal disk, flat  
1 metal disk, convex

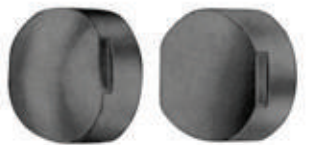

**06-8282** 32g  
1 plastic disk, flat  
1 plastic disk, convex



**06-8283**  
Wrench



# Mallets Weight Refer To The Heads Of The Mallets *Splenor Surgicals*



∅ 45 mm

1/2

**06-8284** 300g  
BERGMANN  
245 mm



∅ 30 mm

1/2

**06-8285** 300g  
BERGMANN  
235 mm



∅ 40 mm

1/2

**06-8286** 550g  
OMBREDANNE  
240 mm



∅ 40 mm

1/2

**06-8287**  
HEATH  
copper filled head  
700 g  
185 mm



# Tampers - Osteotomes, Chisels and Gouges

*Splenor Surgicals*



**06-8288**  
HAASE  
100 mm



**06-8289 - 06-8290**  
PASSOW  
120 mm



**06-8291 - 06-8293**  
CASPAR  
200 mm



**06-8294 - 06-8296**  
200 mm



**06-8297** 4mm  
FREER  
Chisel  
160 mm



**06-8298** 4mm  
FREER  
Chisel, curved  
160 mm



**06-8299** 6mm  
FREER  
Gouge  
150 mm



**06-8300** 3.4mm  
Scaphoid gouge,  
downwards curved  
135 mm



**06-8301** 3.4mm  
Scaphoid gouge,  
upwards curved  
135 mm



**06-8302 - 06-8304**  
MANNERFELT modif  
Osteotomes  
**06-8302** 4 mm  
**06-8303** 6 mm  
**06-8304** 8 mm  
155 mm



# Osteotomes Chisels and Gouges

*Splenor Surgicals*



**06-8305** 3mm  
MANNERFELT modif.  
Gouge  
155 mm



**06-8306 - 06-8310**  
Osteotomes  
140 mm

- 06-8306 4 mm
- 06-8307 6 mm
- 06-8308 8 mm
- 06-8309 10 mm
- 06-8310 12 mm



**06-8311 - 06-8315**  
Chisels  
140 mm

- 06-8311 4 mm
- 06-8312 6 mm
- 06-8313 8 mm
- 06-8314 10 mm
- 06-8315 12 mm



**06-8316 - 06-8320**  
Gouges  
140 mm

- 06-8316 4 mm
- 06-8317 6 mm
- 06-8318 8 mm
- 06-8319 10 mm
- 06-8320 12 mm



**PARTSCH**  
**06-8321 - 06-8324**  
Chisels  
140 mm

- 06-8321 3 mm
- 06-8322 4 mm
- 06-8323 5 mm
- 06-8324 6 mm



**PARTSCH**  
**06-8325 - 06-8329**  
Chisels  
170 mm

- 06-8325 3 mm
- 06-8326 4 mm
- 06-8327 5 mm
- 06-8328 6 mm
- 06-8329 7 mm



**PARTSCH**  
**06-8330 - 06-8333**  
Gouges  
140 mm

- 06-8330 3 mm
- 06-8331 4 mm
- 06-8332 5 mm
- 06-8333 6 mm



**PARTSCH**  
**06-8334 - 06-8338**  
Gouges  
170 mm

- 06-8334 3 mm
- 06-8335 4 mm
- 06-8336 5 mm
- 06-8337 6 mm
- 06-8338 7 mm



**LUCAS**  
**06-8339 - 06-8340**  
Chisels  
160 mm

- 06-8339 4 mm
- 06-8340 6 mm



**LUCAS**  
**06-8341 - 06-8342**  
Gouges  
160 mm

- 06-8341 3 mm
- 06-8342 5 mm



# Osteotomes Chisels and Gouges

## Splenor Surgicals



- 06-8343 5 mm
- 06-8344 7 mm
- 06-8345 9 mm
- 06-8346 11 mm

**ALEXANDER**  
06-8343 - 06-8346  
Gouges  
170 mm

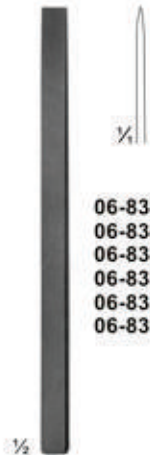

- 06-8347 4 mm
- 06-8348 6 mm
- 06-8349 8 mm
- 06-8350 10 mm
- 06-8351 12 mm
- 06-8352 15 mm

**LAMBOTTE**  
06-8347 - 06-8352  
Osteotomes  
125 mm

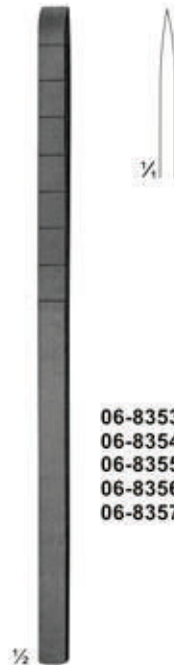

- 06-8353 4 mm
- 06-8354 6 mm
- 06-8355 8 mm
- 06-8356 10 mm
- 06-8357 12 mm

**COTTLE**  
06-8353 - 06-8357  
Osteotomes with depth  
markings  
180 mm



- 06-8358 4 mm
- 06-8359 7 mm
- 06-8360 9 mm
- 06-8361 12 mm

**COTTLE**  
06-8358 - 06-8361  
Chisel-Osteotomes  
with depth markings  
180 mm



**COTTLE**  
06-8362 8mm  
Fishtail Chisel,  
with protected ends  
180 mm



- 06-8363 10 mm
- 06-8364 12 mm
- 06-8365 15 mm
- 06-8366 20 mm
- 06-8367 25 mm

**STILLE**  
06-8363 - 06-8367  
Chisels  
205 mm



- 06-8368 10 mm
- 06-8369 12 mm
- 06-8370 15 mm
- 06-8371 20 mm
- 06-8372 25 mm

**STILLE**  
06-8368 - 06-8372  
Gouges  
205 mm



- 06-8373 10 mm
- 06-8374 15 mm

**WALTER**  
06-8373 - 06-8374  
gouges for taking  
grafts from the ribs  
205 mm



- 06-8375 8mm
- 06-8376 10 mm
- 06-8377 12 mm
- 06-8378 15 mm
- 06-8379 20 mm
- 06-8380 25 mm

**STILLE**  
06-8375 - 06-8380  
Osteotomes  
205 mm













<p>1/2</p> <p><b>06-8381</b> 10 mm  <b>06-8382</b> 12 mm  <b>06-8383</b> 15 mm  <b>06-8384</b> 20 mm  <b>06-8385</b> 25 mm</p>	<p>1/2</p> <p><b>06-8386</b> 10 mm  <b>06-8387</b> 12 mm  <b>06-8388</b> 15 mm  <b>06-8389</b> 20 mm  <b>06-8390</b> 25 mm</p>	<p>1/4</p> <p><b>06-8391</b> 4 mm  <b>06-8392</b> 8 mm  <b>06-8393</b> 10 mm  <b>06-8394</b> 13 mm  <b>06-8395</b> 15 mm  <b>06-8396</b> 18 mm  <b>06-8397</b> 20 mm  <b>06-8398</b> 25 mm  <b>06-8399</b> 30 mm  <b>06-8400</b> 38 mm  <b>06-8401</b> 44 mm  <b>06-8402</b> 50 mm</p>	<p>1/4</p> <p><b>06-8403</b> 8 mm  <b>06-8404</b> 13 mm  <b>06-8405</b> 18 mm  <b>06-8406</b> 25 mm  <b>06-8407</b> 30 mm  <b>06-8408</b> 38 mm</p>
--	--	--	---

<p><b>STILLE</b>  <b>06-8381 - 06-8385</b>          Osteotomes          205 mm</p>	<p><b>STILLE</b>  <b>06-8386 - 06-8390</b>          Osteotomes, curved          205 mm</p>	<p><b>LAMBOTTE</b>  <b>06-8391 - 06-8402</b>          Osteotomes          245 mm</p>	<p><b>LAMBOTTE</b>  <b>06-8403 - 06-8408</b>          Osteotomes, curved          245 mm</p>
--	--	--	--



# Osteotomes, Chisels and Gouges with HARTPRESS -handle

  <p>06-8409 4 mm 06-8410 6 mm 06-8411 8 mm 06-8412 10 mm 06-8413 12 mm</p>	  <p>06-8414 4 mm 06-8415 6 mm 06-8416 8 mm 06-8417 10 mm 06-8418 12 mm</p>	  <p>06-8419 5 mm 06-8420 7 mm 06-8421 10 mm 06-8422 15 mm 06-8423 20 mm 06-8424 25 mm 06-8425 30 mm</p>
<p>LEXER-MINI 06-8409 - 06-8413 Osteotomes 180 mm</p>   <p>06-8426 5 mm 06-8427 7 mm 06-8428 10 mm 06-8429 15 mm 06-8430 20 mm 06-8431 25 mm 06-8432 30 mm</p> <p>LEXER 06-8426 - 06-8432 Osteotomes 220 mm</p>	<p>LEXER-MINI 06-8414 - 06-8418 Gouges 180 mm</p>   <p>06-8433 9mm Gouge for removing broken screws 220 mm</p>	<p>LEXER 06-8419 - 06-8425 Gouges 220 mm</p>   <p>06-8434 5,5 mm 06-8435 9,0 mm</p> <p>ZIELKE 06-8434 - 06-8435 Gouges for scoliosis-operations 230 mm</p>



# Osteotomes , Chisels and Gouges with HARTPRESS -handle

*Splenor Surgicals*

 <p data-bbox="308 1389 495 1446"> <b>06-8436</b> 10 mm  <b>06-8437</b> 15 mm         </p> <p data-bbox="113 1744 349 1928"> <math>\frac{1}{2}</math>  <b>LEXER</b>  <b>06-8436 - 06-8437</b>            Osteotomes,            angled            275 mm         </p>	 <p data-bbox="738 1389 925 1446"> <b>06-8438</b> 10 mm  <b>06-8439</b> 15 mm         </p> <p data-bbox="519 1744 755 1928"> <math>\frac{1}{2}</math>  <b>LEXER</b>  <b>06-8438 - 06-8439</b>            Gouges,            angled            275 mm         </p>	 <p data-bbox="950 1802 1112 1882"> <b>06-8440</b> 20mm            Chisel            245 mm         </p>	 <p data-bbox="1315 1802 1477 1882"> <b>06-8441</b> 16mm            Chisel, curved            265 mm         </p>
---	---	---	---



# Reposition Forceps

Splenor Surgicals



**06-8442**  
Reposition forceps,  
for small fragments  
135 mm



**06-8443**  
HAASE  
Reposition forceps,  
for mandibular  
fractures  
165 mm



**06-8444**  
REILL  
Reposition forceps,  
170 mm



**06-8445**  
Reposition forceps  
205 mm



**06-8446**  
MEYER  
Reposition forceps  
for fingers, with drill  
guide for KIRSCHNER  
wires up to daim.1.0 mm  
170 mm



# Reposition Forceps, Bone Holding Forceps



**06-8447**  
Patella forceps  
185 mm



**06-8448**  
Forceps with  
ratchet fixation  
140 mm



**06-8449**  
Forceps with  
thread fixation  
170 mm



**06-8450**  
Forceps with  
thread fixation  
235 mm

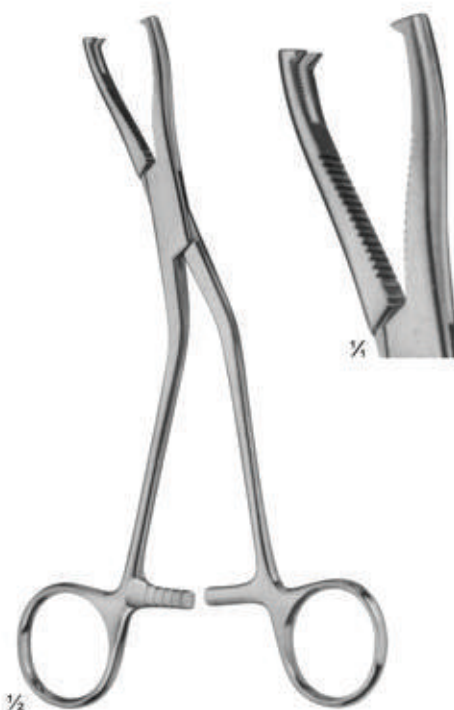

**06-8451**  
DINGMANN modif  
185 mm



**06-8452**  
Sequestrum  
forceps  
200 mm



**06-8453**  
VAN BUREN  
Sequestrum  
forceps  
225 mm



**06-8454**  
LANGENBECK  
205 mm



**06-8455**  
FERGUSSON  
205 mm



# Bone Holding Forceps

*Splenor Surgicals*

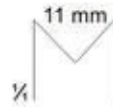
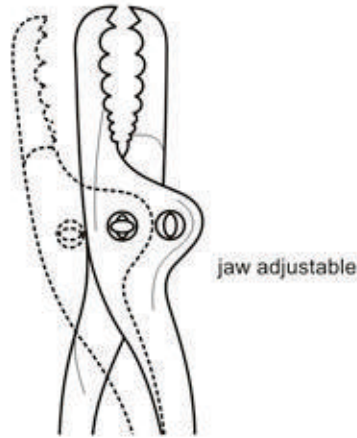

**06-8456**  
SEMB  
190 mm



**06-8457**  
FARABEU  
230 mm



**06-8458**  
FARABEU  
255 mm



**06-8459**  
FARABEU-LAMBOTTE  
255 mm

# Bone Holding Forceps

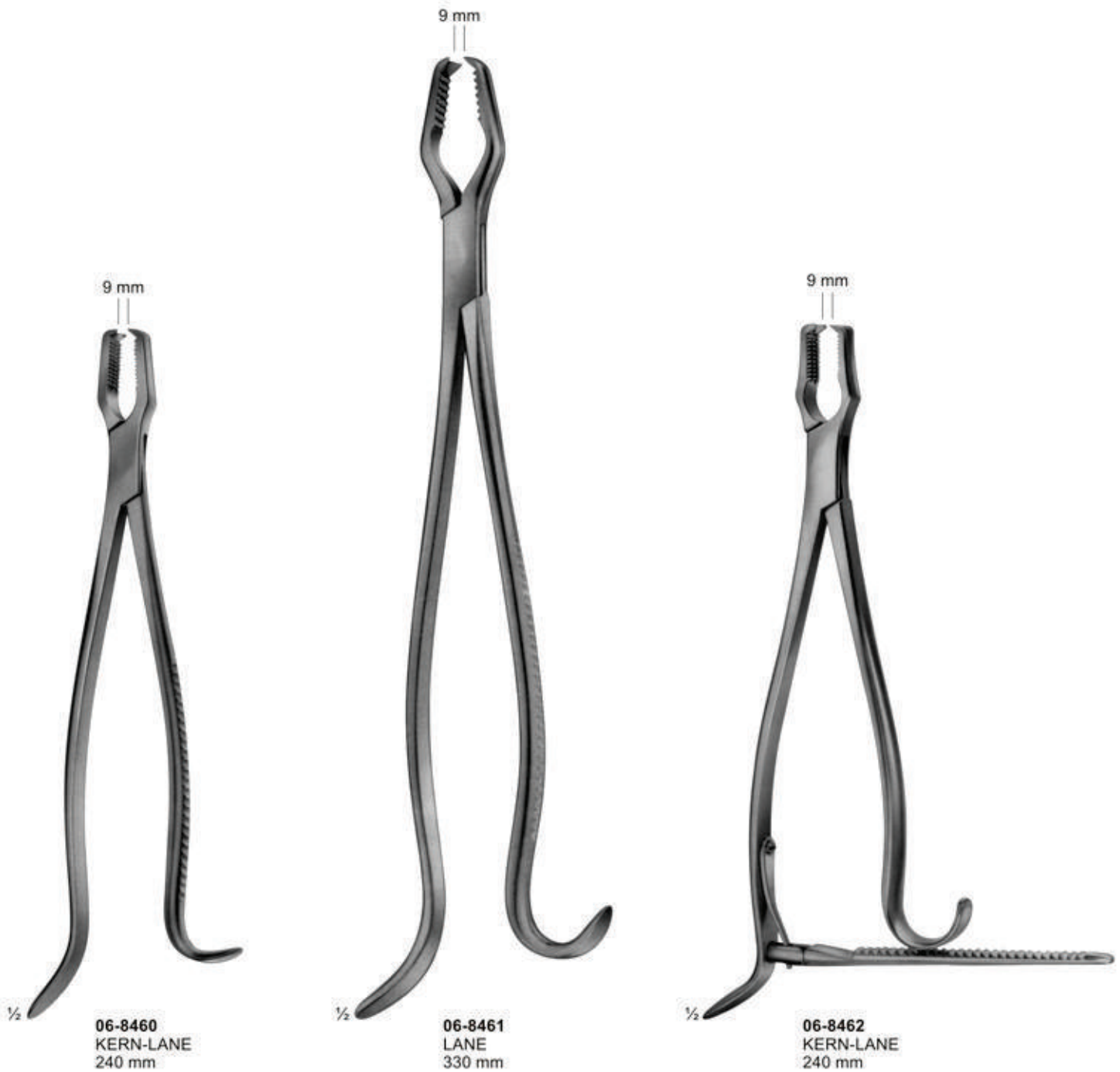



# Bone Holding Forceps

*Splenor Surgicals*



**06-8463**  
LANE  
320 mm



**06-8464**  
HEY GROVES  
305 mm





# Bone Holding Forceps

*Splenor Surgicals*

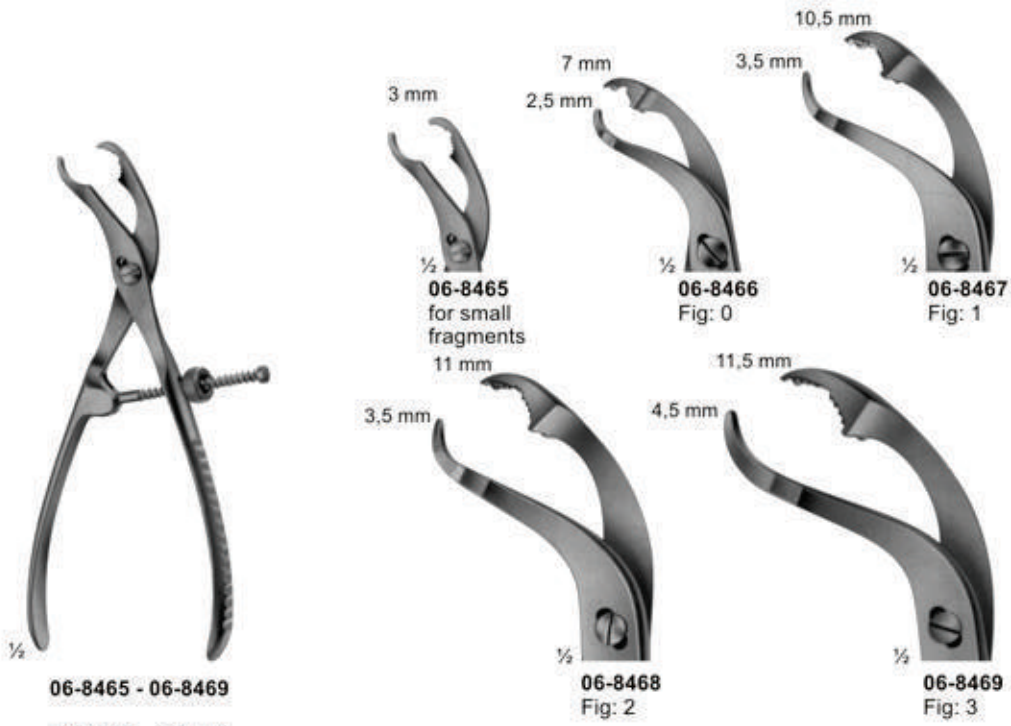

**06-8465 - 06-8469**

- 06-8465** 145 mm
- 06-8466** 190 mm
- 06-8467** 240 mm
- 06-8468** 260 mm
- 06-8469** 280 mm

Self-centering forceps with thread fixation

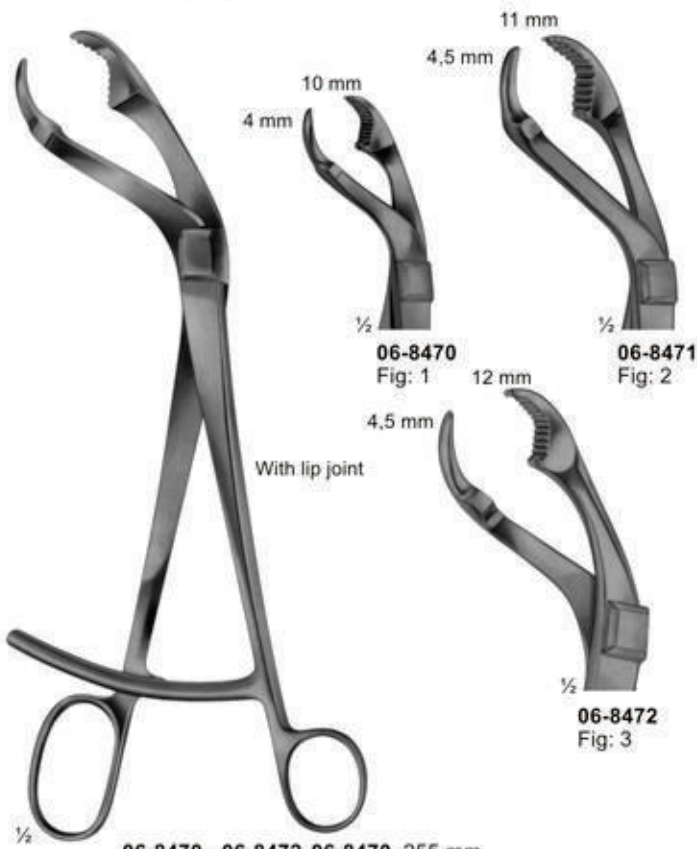

**06-8470 - 06-8472 VERBRUGGE**

- 06-8470** 255 mm
- 06-8471** 265 mm
- 06-8472** 270 mm

With lip joint



**06-8473 LAMBOTTE**  
265 mm



## Bone Clamps

*Splenor Surgicals*



06-8474 - 06-8475  
LOWMAN  
06-8474 170 mm  
06-8475 205 mm



06-8476  
LOWMAN-GERSTER  
210 mm



06-8477  
LOWMAN-HOGLUND  
175 mm

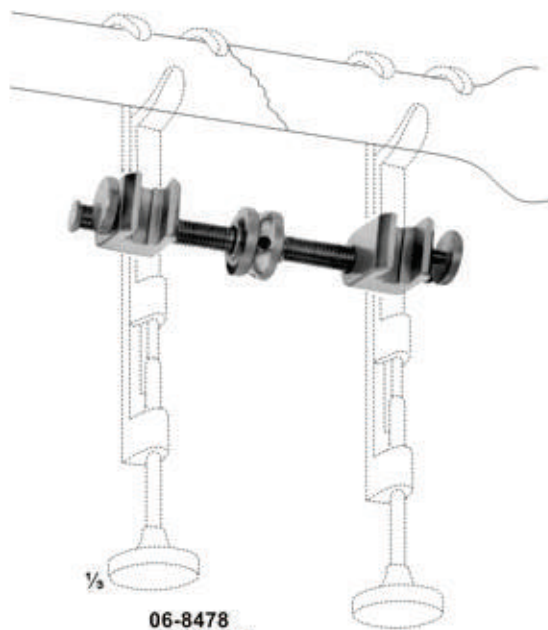

06-8478  
GERSTER  
Traction bar for 06-8474 - 06-8477

Synovectomy-Rongeurs, Bone Rongeurs



06-8479 06-8480

**06-8479 - 06-8480**  
Synovectomy rongeur  
width of jaws 1.2 mm  
130 mm



06-8481 06-8482

**06-8481 - 06-8482**  
Synovectomy rongeur  
width of jaws 2.0 mm  
130 mm



**06-8483**  
**STELLBRINK**  
Synovectomy rongeur  
175 mm



**06-8484**  
**STELLBRINK**  
Synovectomy rongeur  
170 mm



**06-8485**  
**LUER-FRIEDMANN**  
145 mm



**06-8486**  
140 mm



# Bone Rongeurs

*Splenor Surgicals*



06-8487  
LUER  
150 mm



06-8488  
LUER  
155 mm



06-8489  
BLUMENTHAL  
155 mm



06-8490  
BLUMENTHAL  
150 mm



06-8491 - 06-8492  
JANSEN  
175 mm



06-8493  
BANE-HARTMANN  
175 mm

# Bone Rongeurs



**06-8494**  
ALEXANDER  
140 mm



**06-8495**  
JANSEN  
190 mm



**06-8496**



**06-8497**

**06-8496 - 06-8497**  
LEMPERT  
200 mm



**06-8498**  
BEYER  
180 mm



**06-8499**  
MEAD  
165 mm



**06-8500**  
MEAD  
165 mm



# Bone Rongeurs

*Splenor Surgicals*





06-8509  
RUSKIN  
190 mm



06-8510  
ROETTGEN-RUSKIN  
240 mm



06-8511 - 06-8512  
ECHLIN  
230 mm



06-8513  
STILLE  
235 mm



06-8514  
LEKSELL-STILLE  
240mm



06-8515  
STILLE-RUSKIN  
240mm





**06-8516**  
LUER-STILLE  
225 mm



**06-8517**  
LUER-STILLE  
225 mm



06-8518  
LUER-STILLE  
270 mm



06-8519  
SEMB  
240 mm

# Bone Cutting Forceps



**06-8520**  
STAMM  
150 mm



**06-8521**  
KAZANJIAN  
185 mm



**06-8522 - 06-8525**  
LISTON

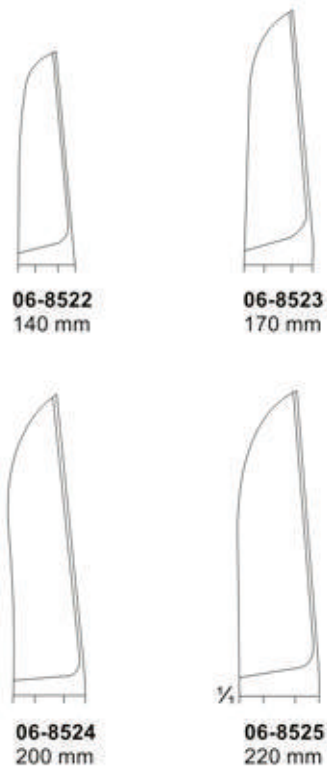

**06-8522**  
140 mm

**06-8523**  
170 mm

**06-8524**  
200 mm

**06-8525**  
220 mm



**06-8526 - 06-8528**  
LISTON

**06-8526**  
170 mm

**06-8527**  
200 mm

**06-8528**  
220 mm



# Bone Cutting Forceps

*Splenor Surgicals*



**06-8529**  
BOEHLER  
145 mm



**06-8530**  
RUSKIN-LISTON  
190 mm



**06-8531**  
RUSKIN-LISTON  
190 mm



**06-8532**  
LISTON  
curved on flat  
240 mm



**06-8533**  
LISTON  
straight  
280 mm

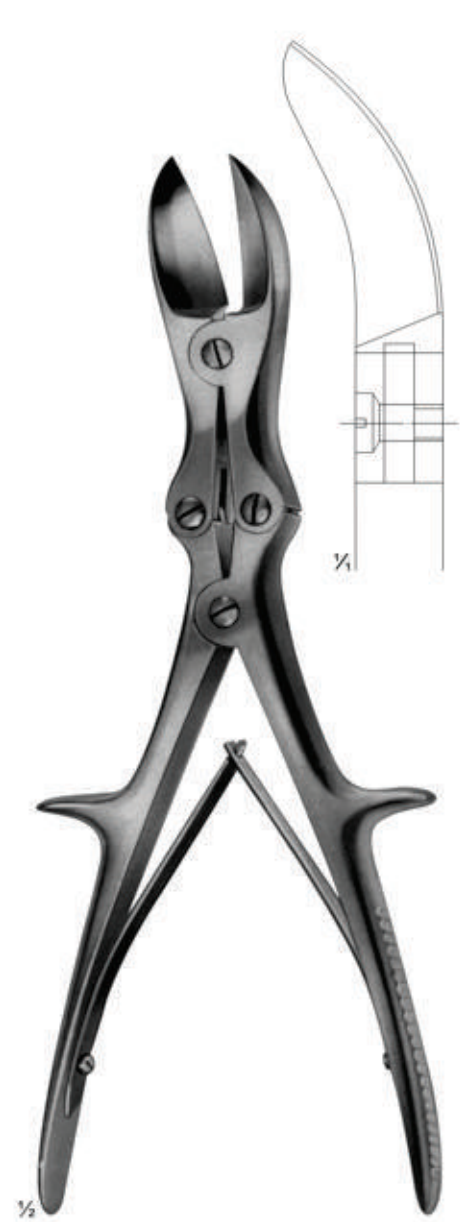

**06-8534**  
LISTON  
curved on flat  
280 mm

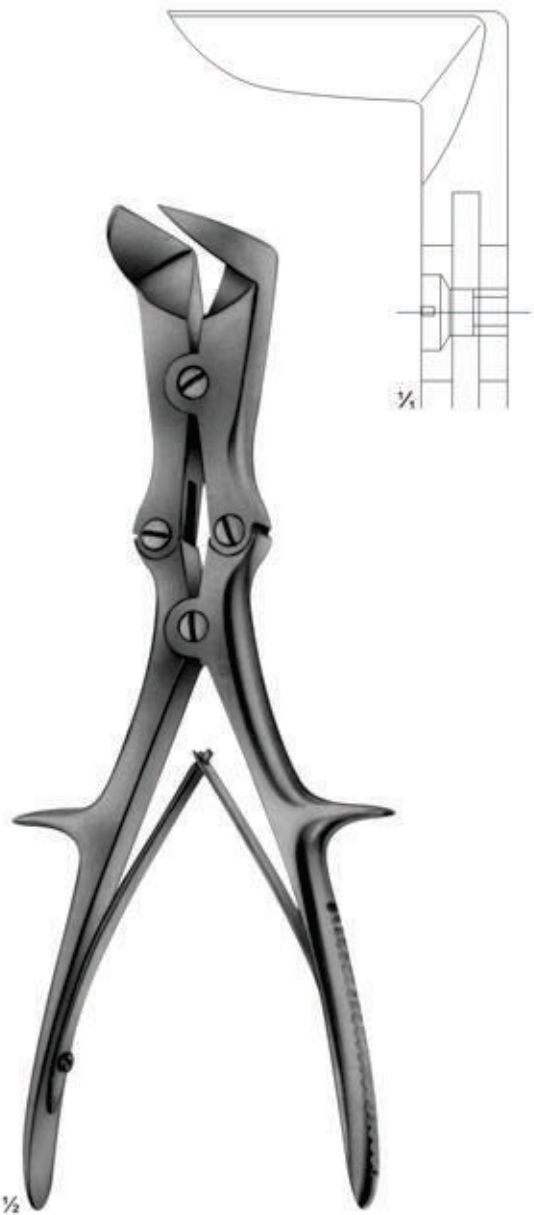

**06-8535**  
LISTON-STILLE  
265 mm

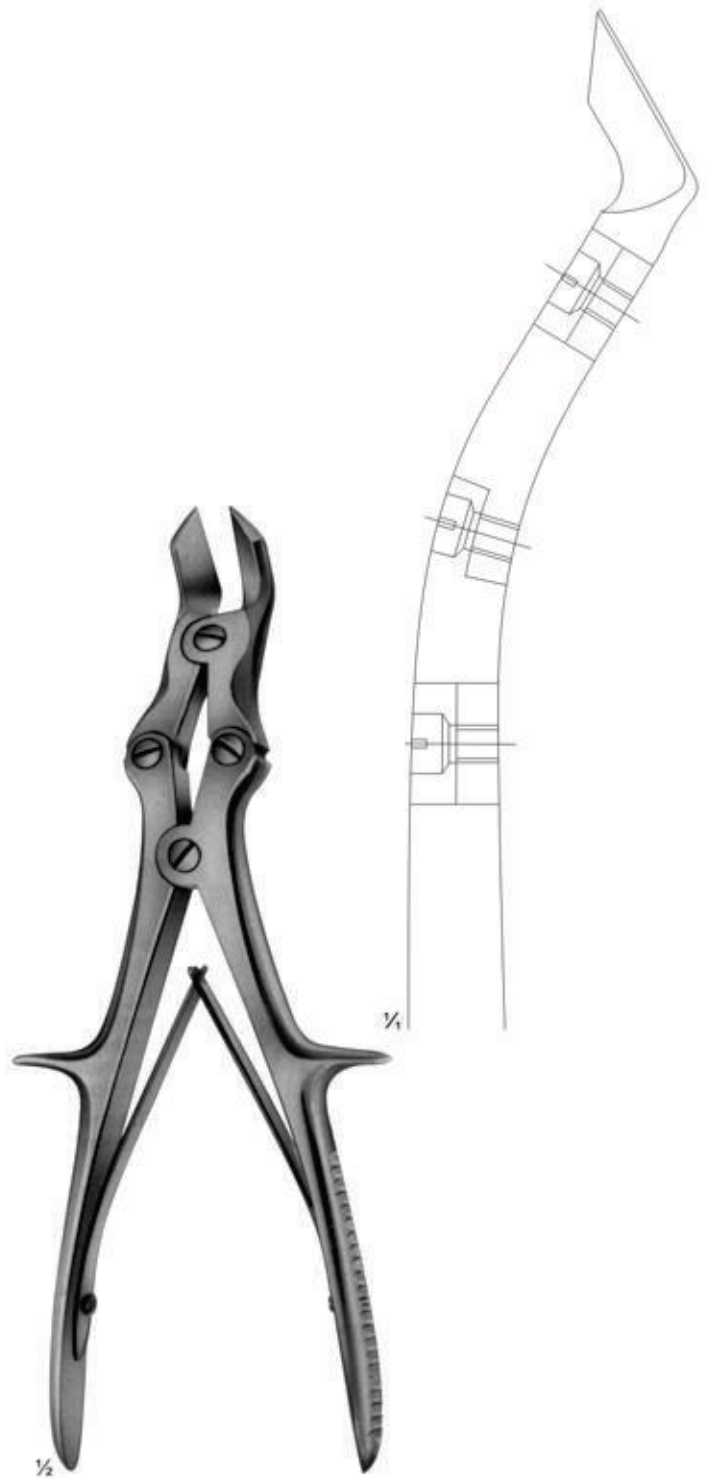

**06-8536**  
LISTON-KEY-HORSLEY  
(TUDOR EDWARDS)  
255 mm



# Meniscus-and Cartilage Forceps

*Splenor Surgicals*

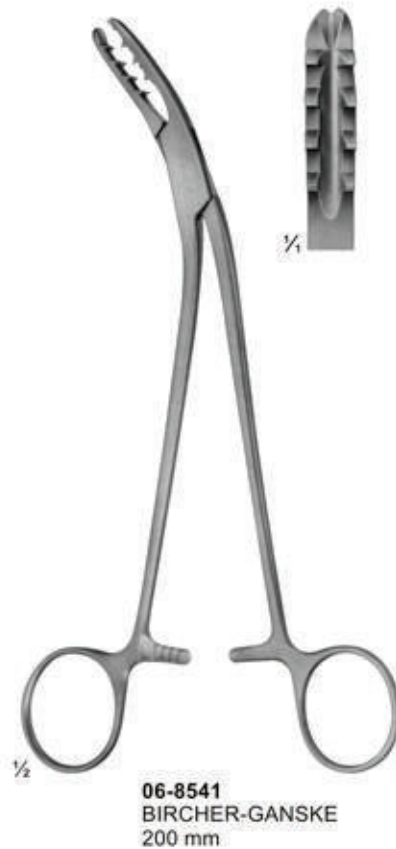

# Meniscus Knives







# Meniscus Knives

*Splenor Surgicals*

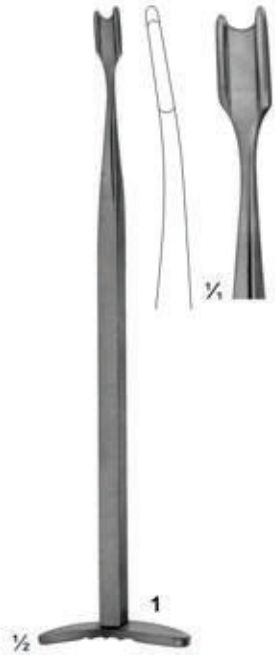

**06-8547  
SMILLIE  
170 mm**

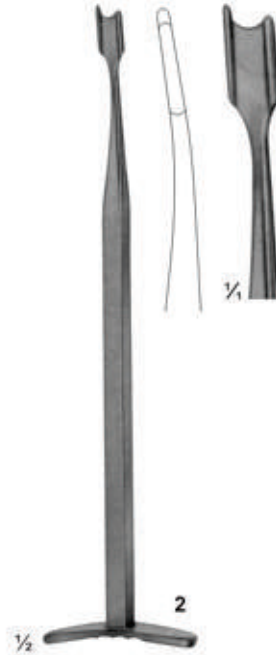

**06-8548  
SMILLIE  
170 mm**



**06-8549  
SMILLIE  
170 mm**



**06-8550  
SALENIUS  
220 mm**

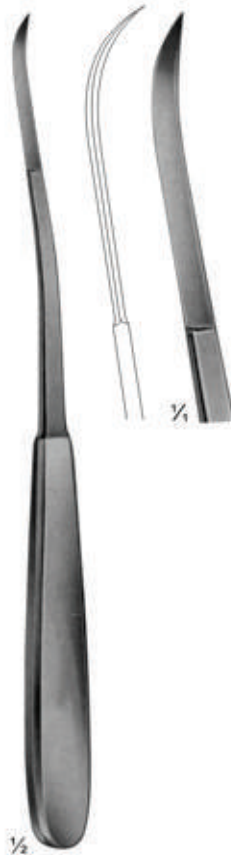

**06-8551  
SALENIUS  
220 mm**



**06-8552  
CANAD. MODELL  
200 mm**



**06-8553  
CANAD. MODELL  
200 mm**



**Wire Extension**

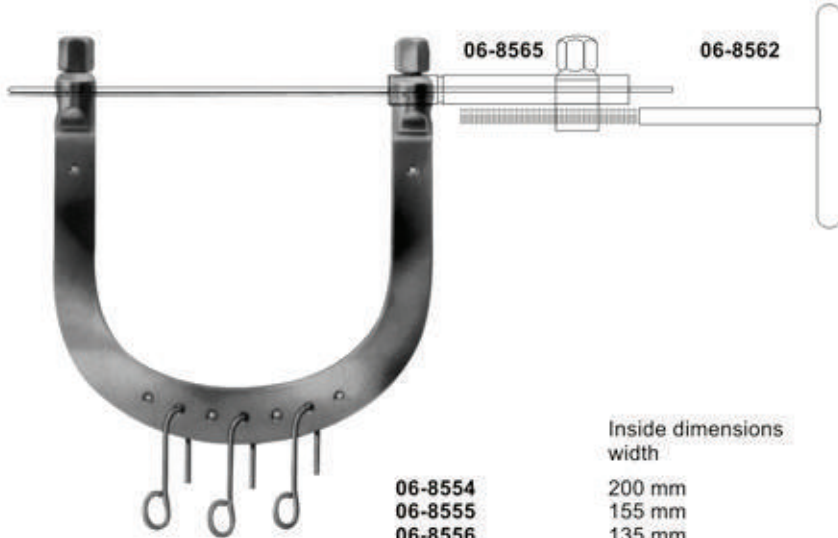

**06-8554 - 06-8560**  
**KIRSCHNER**  
 Wire traction bows,  
 to be used with  
**KIRSCHNER-wires**  
 up to 2.5 mm diam.,  
 With 3 hooks,  
 stainless steel

- 06-8554
- 06-8555
- 06-8556
- 06-8557
- 06-8558
- 06-8559
- 06-8560

Inside dimensions  
width

- 200 mm
- 155 mm
- 135 mm
- 120 mm
- 105 mm
- 95 mm
- 95 mm

depth

- 155 mm
- 155 mm
- 130 mm
- 120 mm
- 100 mm
- 110 mm
- 70 mm

- for the hip
- for the femur
- for the knee
- for the knee
- for the knee
- for the calcaneus
- for the arm and elbow



**06-8561**  
 Wrench, double - ended,  
 for wire traction bows



**06-8562**  
 Wire tightener, with  
 clamping jaws



**06-8563**  
 Traction hook only,  
 large size



**06-8564**  
 Traction hook only,  
 small size



**06-8565**  
 Fixation clamp, to secure clamping  
 jaws of **06-8562** stainless steel



# Wire Extension

*Splenor Surgicals*

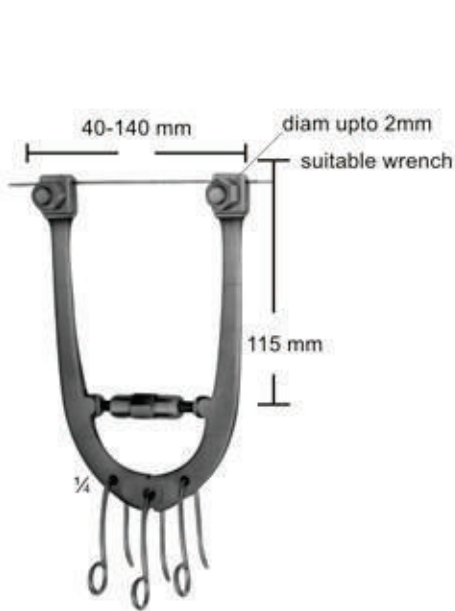

**06-8566**  
Wire traction bow, adjustable, with 3 hooks, small size

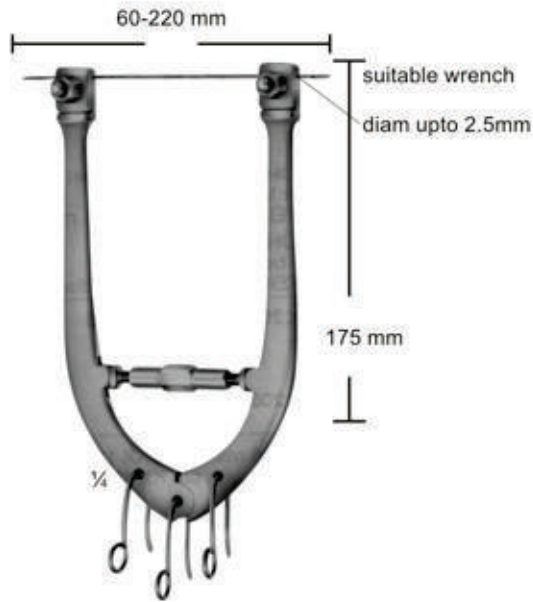

**06-8567**  
Wire traction bow, adjustable, with 3 hooks, large size

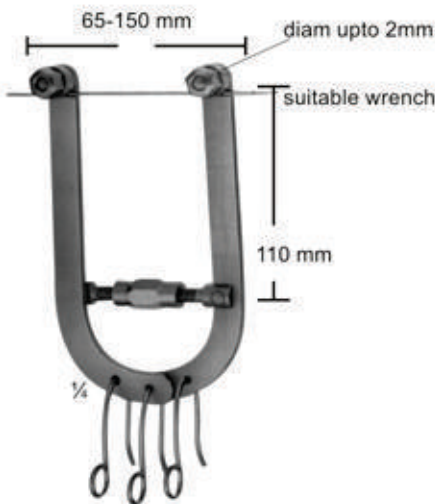

**06-8568**  
Wire traction bow, adjustable, with 3 hooks, small size for elbow and calcaneus, for adolescents



**American Type**

**06-8569** max. 105 mm  
**06-8570** max. 160 mm  
**06-8571** max. 200 mm

**06-8569** 80-95 mm  
**06-8570** 90-120 mm  
**06-8571** 140-170 mm

diam upto  
**06-8569** 1,6 mm  
**06-8570** 2,0 mm  
**06-8571** 2,5 mm



**06-8572**  
Fixation disc, slotted



**06-8573**  
idem, aluminum, transparent to X-rays



**06-8574**  
Fixation disc, slotted



**06-8575**  
Screw driver, for above fixations discs



# Traction Bows, Distractor

*Splenor Surgicals*



Boehler traction bows, to be used with STEINMANN pins, 4mm diam

Boehler traction bows, to be used with STEINMANN pins, 5mm diam

		Inside width	For
06-8576 with pin (09-8588)		16x9cm	Arm
06-8577 without pin	06-8582 without pin		
06-8578 with pin (09-8590)		21x11cm	Femur and knee
06-8579 without pin	06-8583 without pin		
06-8580 with pin (09-8592)		21x15cm	Femur and knee
06-8581 without pin			



**06-8584 - 06-8598**  
STEINMANN  
triangular shaft ended and trocar point

diam $\phi$	4,0 mm	5,0 mm
Length		
80 mm	<b>06-8584</b>	
100 mm	<b>06-8585</b>	
120 mm	<b>06-8586</b>	
140 mm	<b>06-8587</b>	
150 mm	<b>06-8588</b>	<b>06-8594</b>
160 mm	<b>06-8589</b>	
180 mm	<b>06-8590</b>	<b>06-8595</b>
200 mm	<b>06-8591</b>	<b>06-8596</b>
210 mm	<b>06-8592</b>	
250 mm	<b>06-8593</b>	<b>06-8597</b>
300 mm		<b>06-8598</b>



**06-8599**  
**SCHWARZ**  
Traction bow for fingers,  
to be used with KIRSCHNER-  
wire up to 1.6 mm diam.

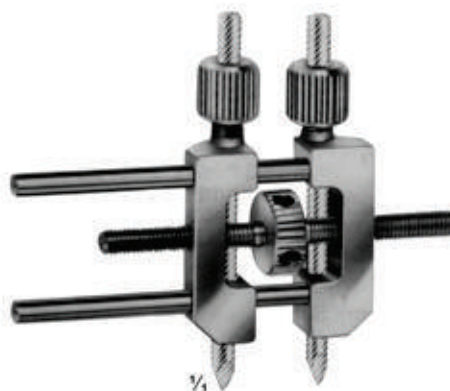

**06-8600**  
Small distractor  
as a repositioning device for  
distraction and compression of small bones,  
for wires with 3.0 mm diam.



**06-8601**  
Protection cap  
for 4,0 mm STEINMANN Pins



**06-8602**  
Protection cap  
for 5,0 mm STEINMANN Pins



# Drilling Chucks and Cerclage Wire Tightener...



1/2

**06-8603**  
REILL  
Drilling chuck, cannulated, for shanks from 2.0 - 2.5 mm diam 115 mm



1/2

**06-8604**  
Drilling chuck, cannulated, for shanks from 0.8 - 2.0 mm diam 150 mm



1/2

**06-8605**  
Drilling chuck, cannulated, for shanks up to 4.5 mm diam with key 140 mm



1/2

**06-8606**  
LOUTE  
Wire tightener, improved pattern, with movable tip, for wires up to 1.0 mm diam. 220 mm

Movable tip made of (material used for implants). While twisting the movable head remains stable, therefore the wire will not slip off.

Chuck jaws made of material used for implants



1/2

**06-8607**  
Drilling chuck, cannulated, for shanks up to 6.35 mm diam., To be tightened by hand 100 mm



1/2

**06-8608**  
Drilling chuck, cannulated, for shanks up to 4.5 mm diam., And for triangular shaft width across flats 4.7 mm (schanz screws, steinmann pins). with key **06-8609**



1/2

**06-8610**  
Drilling chuck, cannulated, for shanks up to 6.35 mm diam., With key **(06-8611)** 160 mm



# Cerclage Instruments

*Splenor Surgicals*



**06-8612**  
275 mm

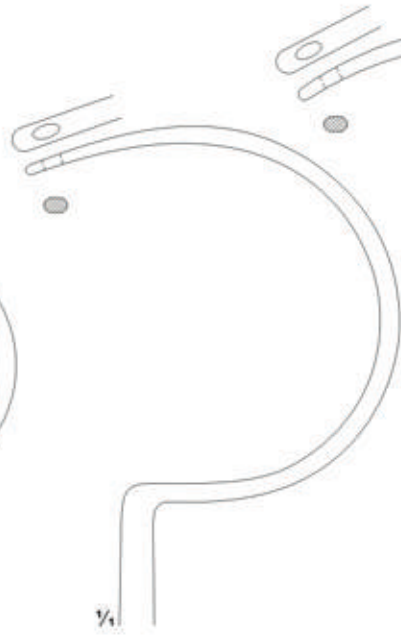

**06-8613**  
285 mm

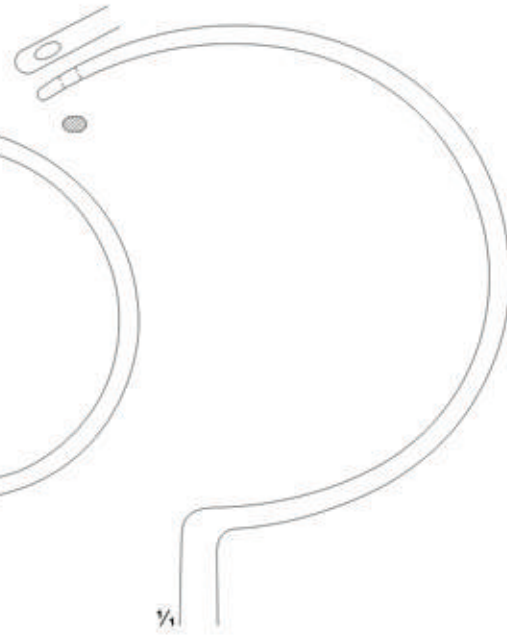

**06-8614**  
305 mm



**06-8612 - 06-8614**  
DEMEL  
Wire guides

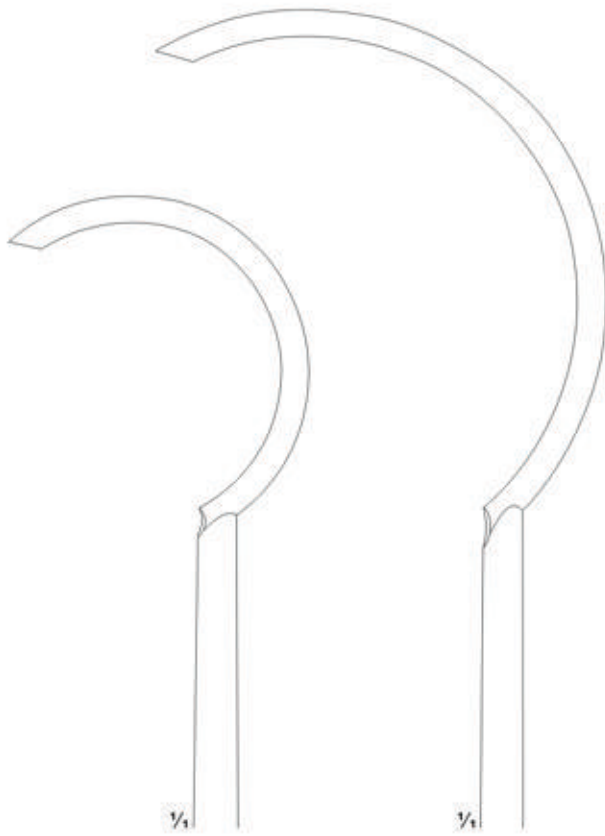

**06-8615**  
240 mm



**06-8616**  
270 mm



**06-8617**  
225 mm

**JORDAN instruments for subcutaneous  
Tibia Cerclage**

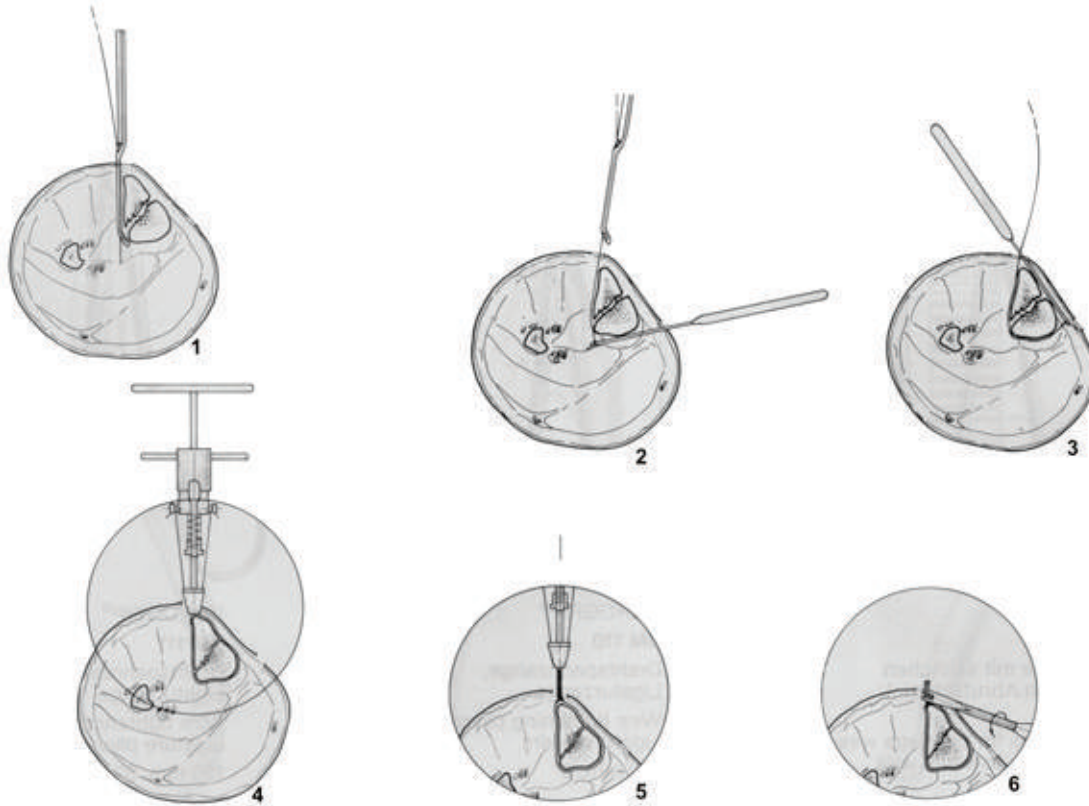

**06-8618**  
JORDAN  
Wire tightener



**06-8619**  
JORDAN  
Wire twister  
170 mm



**06-8620**  
JORDAN  
Wire catcher  
180 mm



**06-8621**  
JORDAN  
Probe, cannulated  
170 mm



Wire Holding forceps, Wire Tightening Pliers, *Splenor Surgicals*  
 Flat-nosed Pliers DUROGRIP with Hard Metal  
 Inserts



**06-8622**  
 DUROGRIP  
 Holding forceps for cerclage  
 wire, with lateral jaws to avoid  
 wire slipping off  
 170 mm



**06-8623**  
 DUROGRIP  
 Wire, tightening pliers,  
 Ligature pliers  
 150 mm



**06-8624**  
 DUROGRIP  
 Wire, tightening pliers,  
 Ligature pliers  
 150 mm



**06-8625**  
 with serrated jaws  
 140 mm



**06-8626**  
 one jaw smooth,  
 one jaw serrated  
 140 mm



**06-8627**  
 with serrated jaws  
**06-8628**  
 with longitudinal and  
 transversal grooves  
 170 mm



**06-8629**  
 190 mm





Wire Holding forceps, Flat-nosed Pliers,  
Pliers for bending and cutting wires

*Splenor Surgicals*



06-8630  
130 mm

06-8631  
180 mm

06-8630 - 06-8631  
Extraction pliers  
for boring wires



06-8632  
Flat-nosed pliers,  
parallel  
185 mm



06-8633  
Vise grip  
200 mm

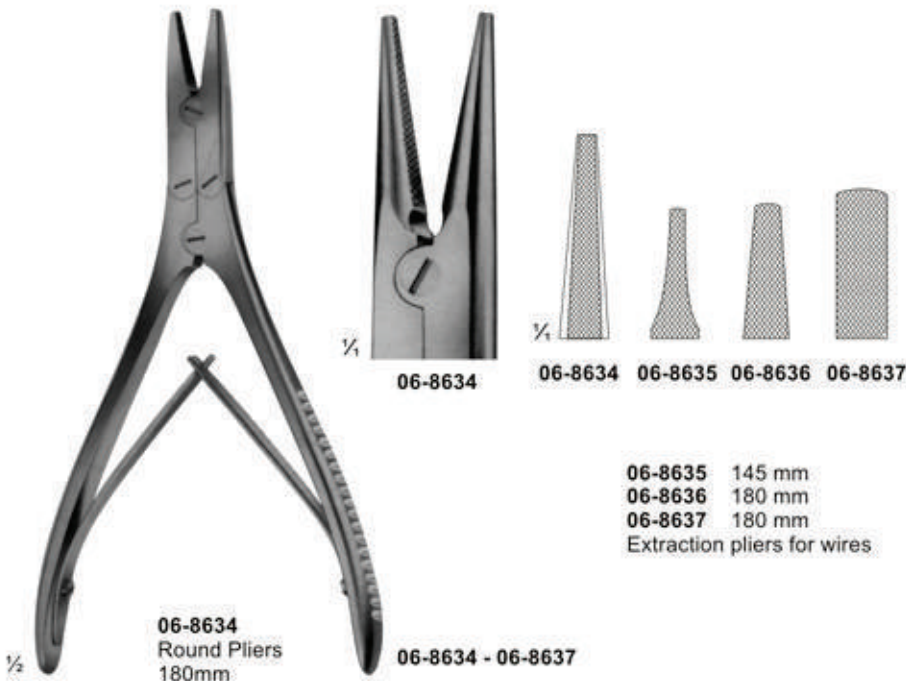

06-8634  
Round Pliers  
180mm

06-8634 - 06-8637

06-8635 145 mm  
06-8636 180 mm  
06-8637 180 mm  
Extraction pliers for wires



06-8638  
Bending pliers  
for wires up to  
1.8 mm diam.



# Wire Cutters and wire Cutting Scissors DUROTIP with Carbide Cutting Edges

*Splenor Surgicals*



**06-8639** **06-8640**  
ANGLE DURETIP  
130 mm ANGLE  
130 mm

for soft wire up to diam.	0,5 mm	0,6 mm
for hard wire up to diam.	0,3 mm	0,4 mm

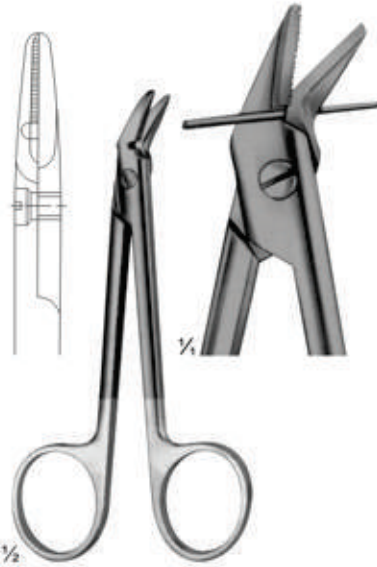

**06-8641** **06-8642**  
120 mm DURETIP  
120 mm

for soft wire up to diam.	1,2 mm	1,2 mm
for hard wire up to diam.	0,8 mm	0,8 mm

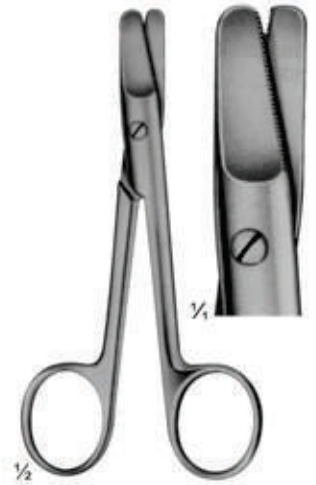

**06-8643**  
HARVEY  
125 mm

0,4 mm
0,3 mm



**06-8644**  
150 mm

for soft wire up to diam	1,5 mm
for hard wire up to diam	1,0 mm



**06-8645**  
160 mm

1,5 mm
1,2 mm



**06-8646**  
140 mm  
DURETIP  
1,5 mm

1,0 mm
--------

Wire Cutting Pliers, Lateral Cutting Action *Splenor Surgicals*



**06-8647**  
180 mm

for soft wire  
up to diam. 2,0 mm  
For hard wire 1,5 mm  
up to diam  
specially hardened  
cutting edges, front  
and lateral cutting  
action



**06-8648**  
REILL  
175 mm

for soft wire  
up to diam. 2,0 mm  
For hard wire 1,6 mm  
up to diam  
specially hardened  
cutting edges, for  
cutting off wires close  
to the bone



**DUROTIP**

**06-8649**  
235 mm

for soft wire  
up to diam. 3,0 mm  
For hard wire 2,2 mm  
up to diam

# Wire Cutting Pliers, Lateral and Front Cutting Action



**06-8650**  
240 mm

for soft wire  
up to diam. 2,0 mm  
For hard wire  
up to diam 1,6 mm



**06-8651**  
145 mm

for soft wire  
up to diam. 1,5 mm  
For hard wire  
up to diam 1,0 mm



**06-8652**  
145 mm

for soft wire  
up to diam. 2,0 mm  
For hard wire  
up to diam 1,5 mm



**06-8653**  
220 mm

for soft wire  
up to diam. 3,5 mm  
For hard wire  
up to diam 2,5 mm



# Wire Cutting Pliers

*Splenor Surgicals*



**06-8654**  
320 mm

for soft wire  
up to diam. 3,0 mm  
For hard wire  
up to diam 3,0 mm



Cutter for cutting off  
KIRSCHNER wires,  
Tibia head screws,  
bolts, pins, up to 3 mm diam.



**DUROTIP**

**06-8655**  
Cutter for cutting off  
KIRSCHNER wires,  
Tibia head screws,  
bolts, pins, up to 6 mm diam.  
470 mm



# Finger Nail Instruments

*Splenor Surgicals*



**06-8656**  
Nail extracting  
forceps  
135 mm



**06-8657**  
Nail extracting  
forceps  
145 mm



**06-8658**  
Finger nail drill  
with 3 drill points

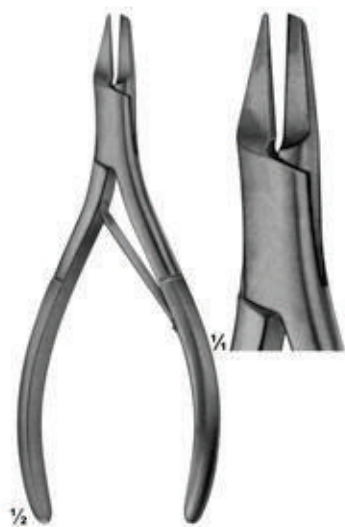

**06-8662**  
Nail splitting  
forceps  
135 mm



**06-8663**  
SYSTRUNK  
Scissors, for splitting  
finger nails  
130 mm



**06-8664**  
Finger ring saw  
150 mm

Spare blade  
**06-8665**





Plaster Instruments

Plaster Knives



with ebony handle

07-9001  
HOPKINS  
200 mm



07-9002  
ESMARCH  
180 mm

Plaster Saw



07-9003  
ENGEL  
160 mm

Bandage and First-Aid scissors



07-9004 - 07-9012 145mm

- |         |             |         |             |
|---------|-------------|---------|-------------|
| 07-9004 | black       | 07-9008 | yellow      |
| 07-9005 | red         | 07-9009 | white       |
| 07-9006 | blue        | 07-9010 | orange      |
| 07-9007 | light green | 07-9011 | voilet      |
|         |             | 07-9012 | bright pink |



07-9013 - 07-9021 180mm

- |         |             |         |             |
|---------|-------------|---------|-------------|
| 07-9013 | black       | 07-9017 | yellow      |
| 07-9014 | red         | 07-9018 | white       |
| 07-9015 | blue        | 07-9019 | orange      |
| 07-9016 | light green | 07-9020 | voilet      |
|         |             | 07-9021 | bright pink |





# Plaster Scissors

Splenor Surgicals

For small plaster dressings



**07-9022**  
160 mm

1/2



**07-9023 - 07-9024**  
ESMARCH  
**07-9023** 200mm  
**07-9024** 230mm

1/2



**07-9025**  
BERGMANN  
230 mm

1/2



**07-9026**  
BRUNS  
235 mm

1/2



**07-9027**  
235 mm

1/2

also to be used as  
bandage scissors



**07-9028**  
SEUTIN  
230 mm

1/2

also to be used as  
bandage scissors



# Plaster Shears

*Splenor Surgicals*

**Special features:**

The construction of the open jaws avoids tiresome clogging by plaster remnants and allows furthermore an easy cleaning. The shears do not glide off the plaster owing to the deep teething on the jaws. The knives with hollow grinding have a better cutting ability and therefore less force is required. The knives are guided by ball bearings.

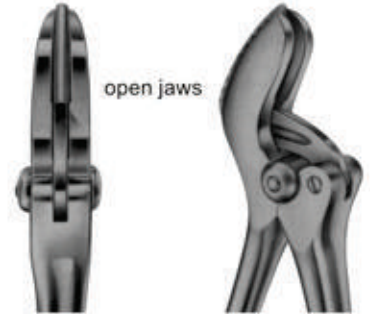

open jaws



07-9029A

Spare blade

open jaws

1/2

07-9029  
STILLE  
260 mm



07-9031

Spare blade

open jaws

1/2

07-9030  
STILLE  
360 mm

# STILLE Plaster Shears

Blade with reinforced back



**07-9032**  
STILLE  
230 mm

**07-9033**  
Spare blade



**07-9034**  
STILLE  
370 mm

**07-9035**  
Spare blade



**07-9036**  
STILLE  
240 mm

**07-9037**  
Spare blade



07-9038  
HENNIG  
270 mm



07-9039  
MOD.USA  
230 mm



07-9040  
290 mm



with removable jaws



07-9041 - 07-9042  
WOLFF  
07-9041 180 mm  
07-9042 240 mm  
plaster breakers

# Vacuum Curettes for Aspiration Lipectomy, Suction Instruments



**07-9043 - 07-9048**  
BIEMER  
**07-9043** ∅4mm  
**07-9044** ∅6mm  
**07-9045** ∅8mm  
**07-9046** ∅10mm  
**07-9047** ∅12mm  
**07-9048** ∅14mm  
 Curettes for aspiration lipectomy, graduated, slightly curved

**07-9049 - 07-9050**  
BIEMER  
**07-9049** ∅4 mm  
**07-9050** ∅6 mm  
 Curettes for aspiration lipectomy, with three apertures, slightly curved malleable

**07-9051 - 07-9053**  
BIEMER  
**07-9051** ∅8 mm  
**07-9052** ∅10 mm  
**07-9053** ∅12 mm  
 Curettes for aspiration lipectomy, with three apertures, slightly curved malleable

**07-9054**  
For aspirating fluid from the excretory ducts of large glands and for keeping the operating area clear 170 mm

**07-9055**  
Trocar  
For puncturing 150 mm

**07-9056**  
For clearing large quantities of fluid 190 mm

# Suction Instruments



**07-9057** 150mm  
Suction handle, with vacuum regulator and finger cut-off, brass, mirror-finish chromium-plated



olive  
Ø9 mm

**07-9058** 170mm  
Suction handle, with hand regulation valve and quick-shutter, brass, mirror-finish chromium-plated



★ Both suction handles have bayonet fitting olive and can be used for the suction cannulae. Ø9 mm



**07-9059**  
Trocar  
For puncturing  
170 mm



**07-9060**  
Hollow needle, sharp  
150 mm



**07-9061**  
double curved  
For general surgery  
230 mm



**07-9062**  
For tonsillectomy, oral and laryngeal operations  
190 mm



**07-9063**  
For tonsillectomy, oral and laryngeal operations  
220 mm

★ With bayonet fitting to be used with suction handles (07-9057 - 07-9058)

# Suction Instruments

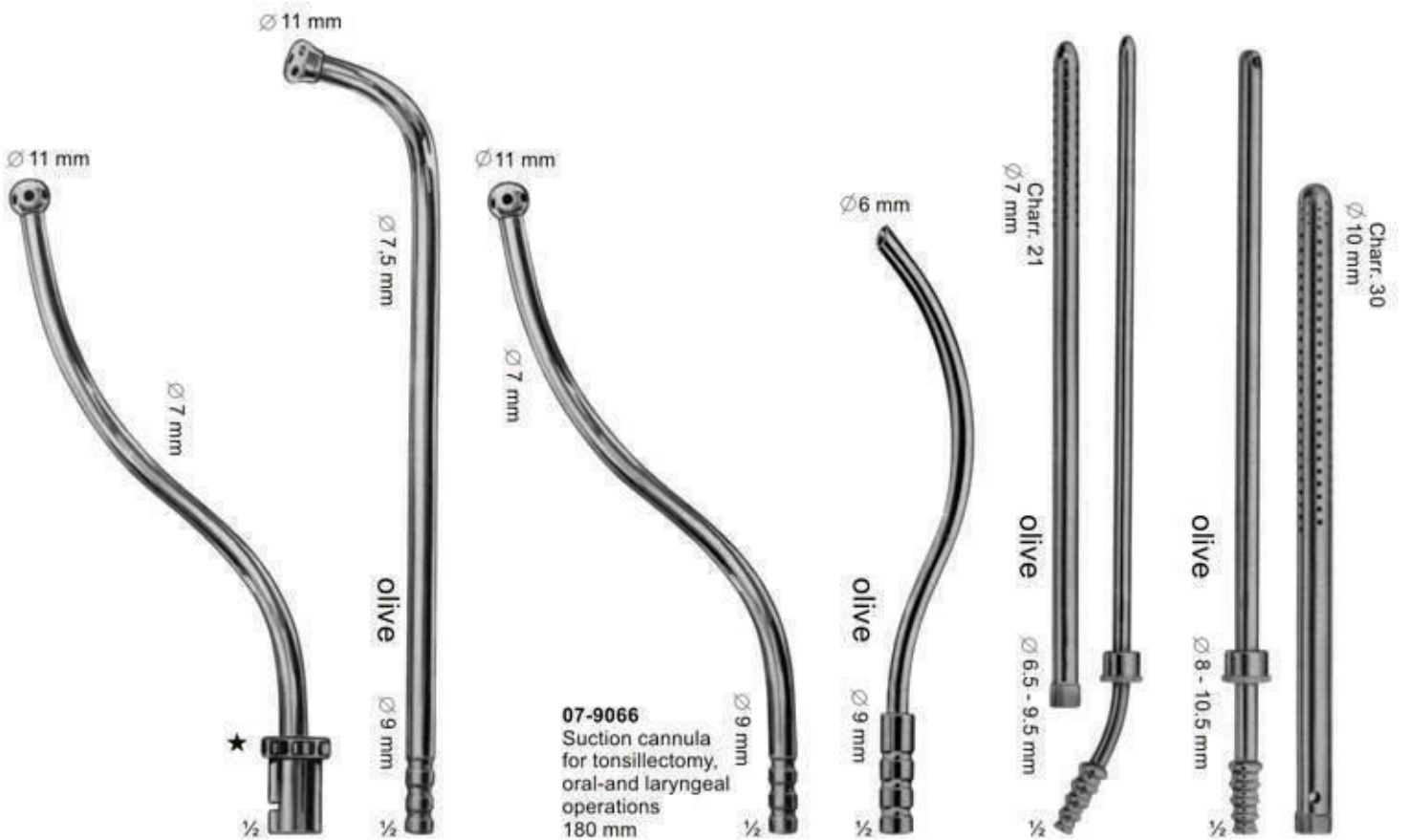

**07-9064**  
For tonsillectomy,  
oral-and laryngeal  
operations  
180 mm

**07-9065**  
Suction cannula  
for tonsillectomy,  
oral-and laryngeal  
operations  
220 mm

**07-9066**  
Suction cannula  
for tonsillectomy,  
oral-and laryngeal  
operations  
180 mm

**07-9067**  
S-shaped blunt cannula  
for aspirating fluid from  
the excretory ducts of  
large glands and for  
keeping the operating  
area clear  
170 mm

**07-9068**  
POOL  
Suction cannula,  
with outer tube  
to be screwed off  
225 mm

**07-9069**  
POOL  
Suction cannula,  
with outer tube  
to be screwed off  
225 mm

# Suction Instruments





# Suction Instruments



07-9076 Ø 1,5 mm  
07-9077 Ø 2,0 mm  
07-9078 Ø 2,5 mm  
07-9079 Ø 3,0 mm

**07-9076 - 07-9079**  
**PLESTER**  
with finger cut-off and  
stylet, thumb piece  
parallel to curve, with  
LUER hub  
195 mm

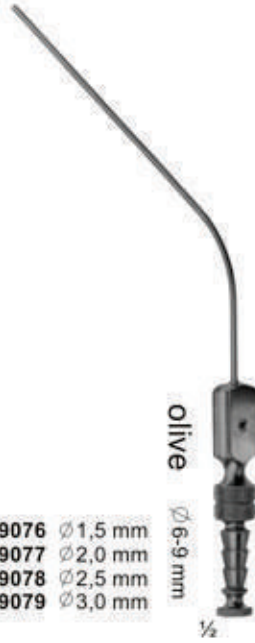

07-9080 Ø 2,0 mm  
07-9081 Ø 2,5 mm  
07-9082 Ø 3,0 mm  
07-9083 Ø 4,0 mm  
07-9084 Ø 5,0 mm

**07-9080 - 07-9084**  
**FERGUSSON**  
with finger cut-off and  
stylet, thumb piece  
90° to curve, with  
LUER hub  
180 mm



**07-9085** Ø 4mm  
**FERGUSSON**  
insulated, with finger cut-off  
and stylet, thumb piece 90°  
to curve, with LUER hub  
180 mm



**07-9086** Ø 3mm  
**07-9087** Ø 5mm  
**FRAZIER**  
with finger  
cut-off and stylet, thumb  
piece 90° to curve,  
with LUER hub  
180 mm



**07-9088**  
5,0 mm diam., Tip  
6,5 mm wide, Nasal  
suction tube, with  
LUER hub  
180 mm



**07-9089** 4,5 mm  
**07-9090** 5,5 mm  
Nasal suction  
tubes  
175 mm



**07-9091**  
**GORNEY**  
Suction dissector  
180 mm



**07-9092** 4 mm wide  
**07-9093** 5 mm wide  
Suction raspatories,  
sharp, bayonet-shaped,  
with stylet  
200 mm



**07-9094**  
**LOPEZ-REINKE**  
Tonsil dissector with  
suction device  
235 mm

# Suction Instruments



**07-9095**  
**WULLSTEIN**  
 Suction tube, conical, silver, olive  
 with LUER hub  
 160 mm



**07-9096** 1,5 mm  
**07-9097** 2,0 mm  
**WULLSTEIN**  
 Suction tube, cylindrical, silver, with  
 stylet olive with LUER hub  
 160 mm



Usable length

YASARGIL		usable length	diam.	YASARGIL		usable length	diam.
<b>07-9098</b>	130 mm	1,5 mm		<b>07-9106</b>	130 mm	2,5 mm	
<b>07-9099</b>	150 mm	1,5 mm		<b>07-9107</b>	150 mm	2,5 mm	
<b>07-9100</b>	180 mm	1,5 mm		<b>07-9108</b>	180 mm	2,5 mm	
<b>07-9101</b>	220 mm	1,5 mm		<b>07-9109</b>	220 mm	2,5 mm	
<b>07-9102</b>	130 mm	2,0 mm		<b>07-9110</b>	130 mm	3,5 mm	
<b>07-9103</b>	150 mm	2,0 mm		<b>07-9111</b>	150 mm	3,5 mm	
<b>07-9104</b>	180 mm	2,0 mm		<b>07-9112</b>	180 mm	3,5 mm	
<b>07-9105</b>	220 mm	2,0 mm		<b>07-9113</b>	220 mm	3,5 mm	
				<b>07-9114</b>	180 mm	4,5 mm	

olive  
 Ø 6,5-9 mm  
 with LUER hub

**07-9115 - 07-9117**  
**LANDOLT**  
 150 MM  
 diam Ø 3 mm

**07-9115** 8 mm / curved  
**07-9116** 11mm / curved  
**07-9117** 15mm / curved

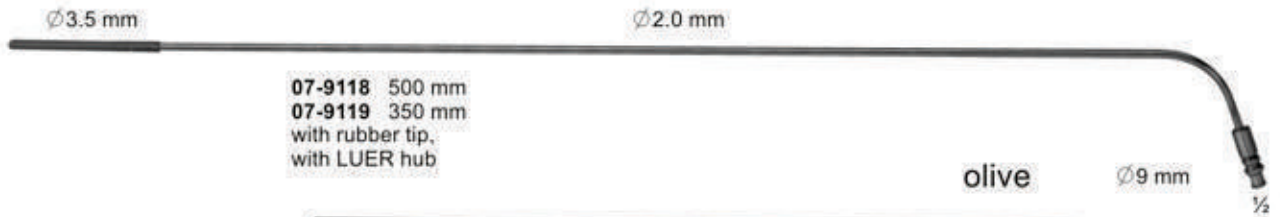
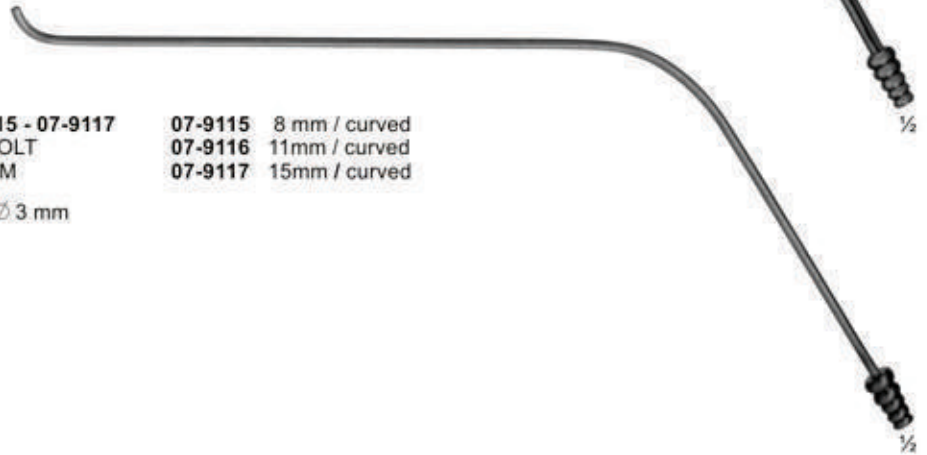

**07-9118** 500 mm  
**07-9119** 350 mm  
 with rubber tip,  
 with LUER hub

**07-9120** 2,0 mm diam  
**07-9121** 2,5 mm diam  
**07-9122** 3,0 mm diam  
 with finger cut-off,  
 thumb piece 90° to  
 curve, with LUER hub  
 250 mm



# Combined Suction and Irrigation Cannulae, Coagulation Suction Cannulae



**07-9124**  
YASARGIL  
LUER-LOCK cone  
200 mm

